

# QBiX-ADNAN97-A1

---

QBiX-ADNAN97-A1 Industrial Embedded System  
Quick Start Guide

## Copyright Notice

---

This document is copyrighted, 2024. All rights are reserved. The original manufacturer reserves the right to make improvements to the products described in this manual at any time without notice.

No part of this manual may be reproduced, copied, translated, or transmitted in any form or by any means without the prior written permission of the original manufacturer. Information provided in this manual is intended to be accurate and reliable. However, the original manufacturer assumes no responsibility for its use, or for any infringements upon the rights of third parties that may result from its use.

The material in this document is for product information only and is subject to change without notice. While reasonable efforts have been made in the preparation of this document to assure its accuracy, GIGAIPC assumes no liabilities resulting from errors or omissions in this document, or from the use of the information contained herein.

GIGAIPC reserves the right to make changes in the product design without notice to its users.

## Acknowledgement

---

All other products' name or trademarks are properties of their respective owners.

- Microsoft Windows is a registered trademark of Microsoft Corp.
- Intel, Pentium, Celeron, and Xeon are registered trademarks of Intel Corporation
- Core, Atom are trademarks of Intel Corporation
- ITE is a trademark of Integrated Technology Express, Inc.
- IBM, PC/AT, PS/2, and VGA are trademarks of International Business Machines Corporation.

All other product names or trademarks are properties of their respective owners.

# Packing List

---

Before setting up your product, please make sure the following items have been shipped:

Item	Quantity
System kit	1
19V / 65W adapter	1
Power cord (May vary based on local distribution)	1
VESA Bracket	1
VESA screw (M4-10L x 4pcs, M3-3L x 2pcs)	1

If any of these items are missing or damaged, please contact your distributor or sales representative immediately.

## About this Document

---

This User's Manual contains all the essential information, such as detailed descriptions and explanations on the product's hardware and software features (if any), its specifications, dimensions, jumper/connector settings/definitions, and driver installation instructions (if any), to facilitate users in setting up their product.

Users may refer to the [GIGAIPC.com](http://GIGAIPC.com) for the latest version of this document.

## Safety Precautions

---

Please read the following safety instructions carefully. It is advised that you keep this manual for future references

1. All cautions and warnings on the device should be noted.
2. Make sure the power source matches the power rating of the device.
3. Position the power cord so that people cannot step on it. Do not place anything over the power cord.
4. Always completely disconnect the power before working on the system's hardware.
5. No connections should be made when the system is powered as a sudden rush of power may damage sensitive electronic components.
6. If the device is not to be used for a long time, disconnect it from the power supply to avoid damage by transient over-voltage.
7. Always disconnect this device from any AC supply before cleaning.
8. While cleaning, use a damp cloth instead of liquid or spray detergents.
9. Make sure the device is installed near a power outlet and is easily accessible.
10. Keep this device away from humidity.
11. Place the device on a solid surface during installation to prevent falls
12. Do not cover the openings on the device to ensure optimal heat dissipation.

13. Watch out for high temperatures when the system is running.
14. Do not touch the heat sink or heat spreader when the system is running
15. Never pour any liquid into the openings. This could cause fire or electric shock.
16. As most electronic components are sensitive to static electrical charge, be sure to ground yourself to prevent static charge when installing the internal components. Use a grounding wrist strap and contain all electronic components in any static-shielded containers.
17. If any of the following situations arises, please the contact our service personnel:
  - i. Damaged power cord or plug
  - ii. Liquid intrusion to the device
  - iii. Exposure to moisture
  - iv. Device is not working as expected or in a manner as described in this manual
  - v. The device is dropped or damaged
  - vi. Any obvious signs of damage displayed on the device
- 18. DO NOT LEAVE THIS DEVICE IN AN UNCONTROLLED ENVIRONMENT WITH TEMPERATURES BEYOND THE DEVICE'S PERMITTED STORAGE TEMPERATURES (SEE CHAPTER 1) TO PREVENT DAMAGE.**

## FCC Statement

---

### **Warning!**



This device complies with Part 15 FCC Rules. Operation is subject to the following two conditions: (1) this device may not cause harmful interference, and (2) this device must accept any interference received including interference that may cause undesired operation.

### **Caution:**

*There is a danger of explosion if the battery is incorrectly replaced. Replace only with the same or equivalent type recommended by the manufacturer. Dispose of used batteries according to the manufacturer's instructions and your local government's recycling or disposal directives.*

### **Attention:**

*Il y a un risque d'explosion si la batterie est remplacée de façon incorrecte. Ne la remplacer qu'avec le même modèle ou équivalent recommandé par le constructeur. Recycler les batteries usées en accord avec les instructions du fabricant et les directives gouvernementales de recyclage.*

## High Temperature Warning

---

(1) This equipment is intended to be used in Restrict Access Location. The access can only be gained by Skilled person or by Instructed person who have been instructed about the metal chassis of the equipment is so hot that Skilled person have to pay special attention or take special protection. Only authorized by well trained professional person can access the restrict access location.

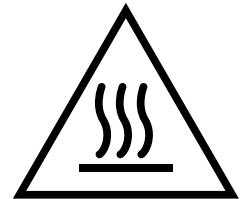

(2) External metal parts are hot!! Before touching it, special attention or protection is necessary



## Table Contents

<b>QBiX-ADNAN97-A1 Industrial Embedded System</b>	<b>1</b>
<b>Quick Start Guide</b>	
Copyright Notice .....	2
Acknowledgement .....	3
Packing List.....	4
About this Document.....	5
Safety Precautions .....	6
FCC Statement.....	8
High Temperature Warning .....	8
<b>Chapter 1 - Product Specifications</b>	<b>11</b>
1.1 Specifications .....	13
<b>Chapter 2 – QBiX-ADNAN97-A1 Industrial Embedded System Kit</b>	<b>15</b>
2.1 Dimension .....	16
2.2 Getting Familiar with Your Unit.....	17
2.3 A) M.2 SSD Installation: How to safely install the M.2 2280 SSD .....	19
2.4 B) Wireless Module : How to safely install the Module (Wireless Module inclusion may vary based on local distribution) .....	20
2.5 C) Memory Installation: DDR5 SO-DIMM .....	21
2.6 Antenna Installation (Antenna inclusion may vary based on local distribution) .....	22
2.7 VESA Bracket .....	23

2.8	Support .....	24
2.9	Safety and Regulatory Information.....	25

## **Chapter 3 – BIOS** **26**

3.1	Introduction .....	27
3.2	The Main Menu.....	28
3.3	Advanced .....	29
3.3.1	TPM Configuration.....	30
3.3.2	CPU Configuration .....	32
3.3.3	SATA Configuration .....	33
3.3.4	Super IO Configuration .....	34
3.3.5	Hardware Monitor .....	35
3.3.6	S5 RTC Wake Settings .....	36
3.3.7	Network Stack Configuration-1.....	37
3.3.7	Network Stack Configuration-2 .....	38
3.3.8	NVMe Configuration.....	39
3.3.9	Offboard SATA Controller Configuration .....	40
3.3.10	Tls Auth Configuration .....	41
3.3.11	Realtek PCIe GBE Family Controller (MAC:74:56:3C:B4:60:62) (MAC address may varied based on different motherboard).....	42
3.3.12	Realtek PCIe GBE Family Controller (MAC:74:56:3C:B4:60:63) (MAC address may varied based on different motherboard).....	43
3.4	Chipset .....	44
3.5	Security .....	45
3.6	Boot.....	48
3.7	Save & Exit .....	49

# Chapter 1

---

## Chapter 1 - Product Specifications

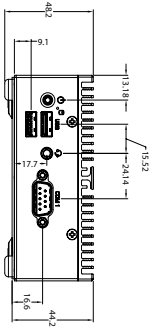
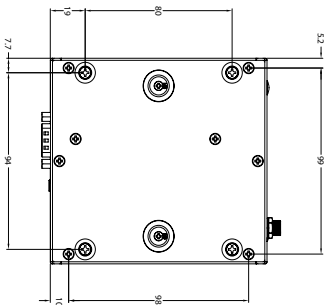
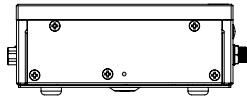
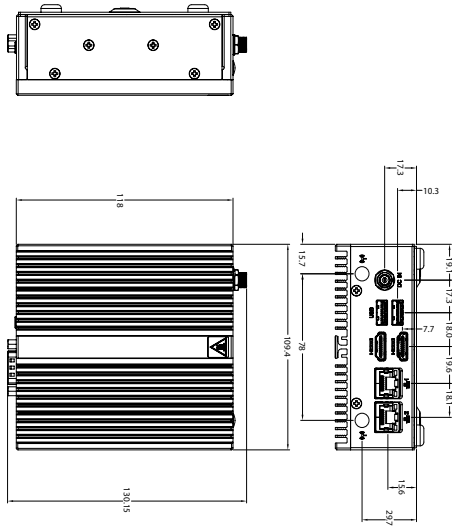
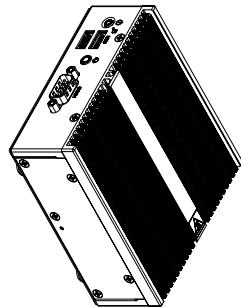

## 1.1 Specifications

System	QBiX-ADNAN97-A1 (QB-N970A-SI)
Dimension	118W x 109.4D x 44.4H (mm)
CPU	Intel Processor N97 Intel 7, 4 cores, up to 3.60 GHz
Memory	1 x DDR5 SO-DIMM socket, Max. Capacity 16 GB Support Single Channel DDR5 4800 MHz memory module
Ethernet	2 x GbE LAN Ports (Realtek® RTL8111H)
Video	Integrated Graphics Processor - Intel® UHD Graphics support: 2 x HDMI 2.0 port, supporting a maximum resolution of 4096x2160 @60Hz  (2 independent display outputs)
Audio	Realtek® ALC269
Storage	—
Expansion Slots	1 x 2280 M.2 M-Key (PCIe Gen 3x1, SATA 6Gb/s) 1 x 2230 M.2 E-Key (WiFi/BT)
Front I/O	2 x USB 3.2 Gen 2x1 1 x COM Port (RS-232) 1 x Combo Audio Jack (Headphone & Headset) 1 x Power button with LED
Rear I/O	2 x RJ45 LAN Ports 2 x USB 3.2 Gen 2x1 2 x HDMI 2 x External Antenna Holes (Optional) 1 x Screw Type DC Jack
Side I/O	—
TPM	Onboard TPM 2.0 security chip NUVOTON NPCT760AABYX
Power	+12V~19VDC (Adapter 19V/65W)
Operation Temperature	Operating temperature: 0°C to 50°C Operating humidity: 0-90% (non-condensing) Non-operating temperature: -40°C to 85°C Non-operating humidity: 0%-95% (non-condensing) Use wide temperature range memory and storage

System	QBiX-ADNAN97-A1 (QB-N970A-SI)
Vibration During Operation	Operation: IEC 60068-2-64, 3 Grms, random, 5 ~ 500 Hz, 1 hr / Per Axis, With SSD Non-operation: IEC 60068-2-6, 2 G, Sine, 10 ~ 500 Hz, 1 Oct/min, 1 hr / Per Axis
Shock During Operation	Operation: IEC 60068-2-27, 50 G, half sine, 11 ms duration with SSD
Packaging Content	Carton size: 373 x 294 x 296 (mm) Packing Capacity: 8pcs  Single Box size: 256 x 173 x 66 (mm)  Including: Power Cord : Optional (by region) PSU ADP 19V 65W 100-240VAC x 1 (P/N: 25EP1-100651-A3S) VESA Bracket x 1 (P/N: 25HB1-TPL021-S8R) VESA Screws x 1 (P/N: 25KSD-000001-S4R)
Order Information	System : 6BQBN970AMR-SI (Box packing)

## Chapter 2

---

### Chapter 2 – QBiX-ADNAN97-A1 Industrial Embedded System Kit

# 2.1 Dimension

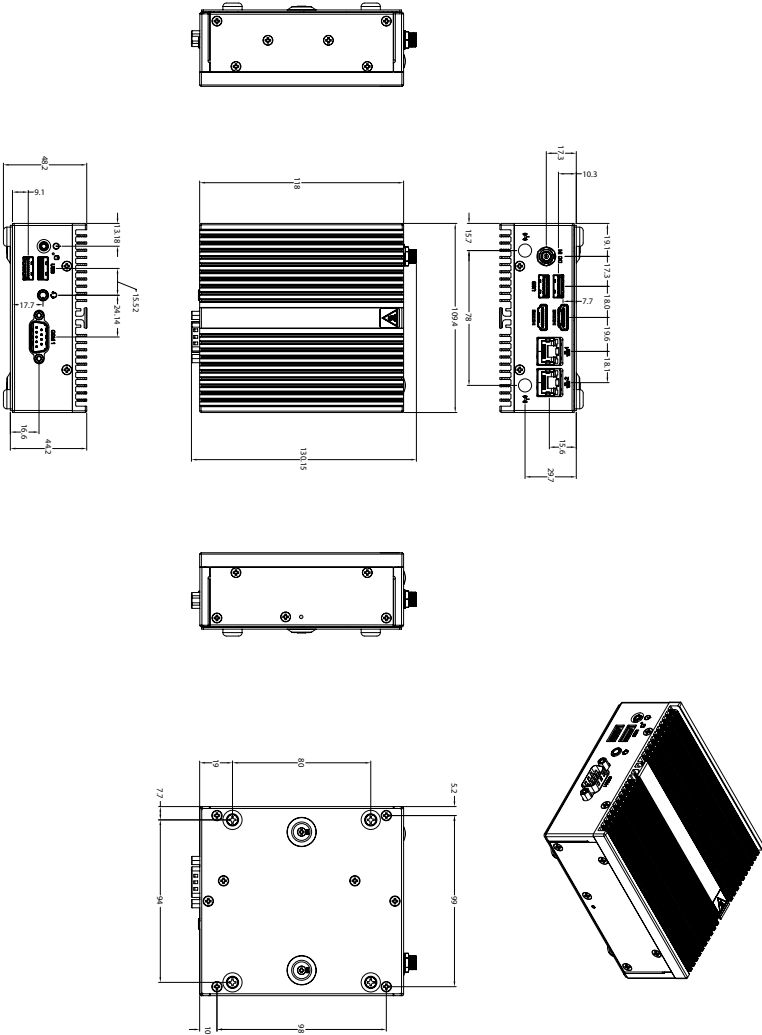



## 2.2 Getting Familiar with Your Unit

### [Front Side]

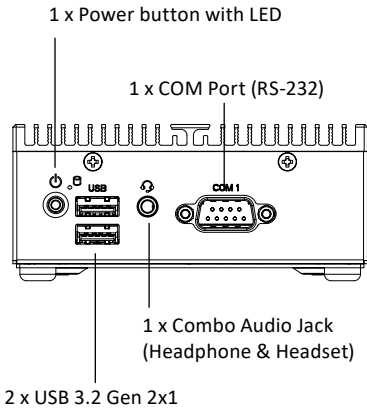

### [Left Side]

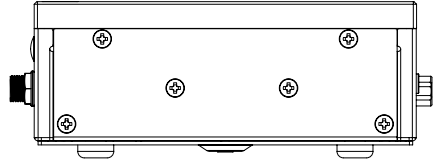

### [Right Side]

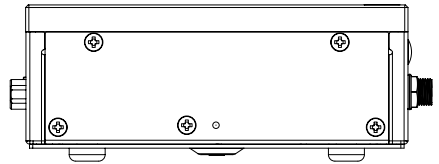

### [Rear Side]

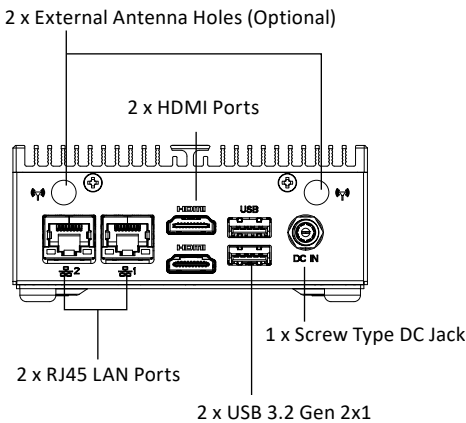

### [Bottom Side]

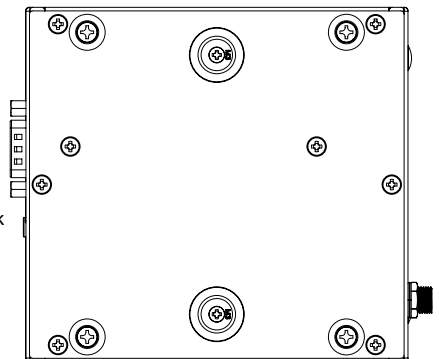

## [Install]

- \* Before opening the case, make sure to unplug the power cord.
- \* 打開機殼前，請確實移除電源。
- \* Before Connecting the power, make sure to fasten the case securely.
- \* 接上電源前，請確實將機殼完整鎖附。

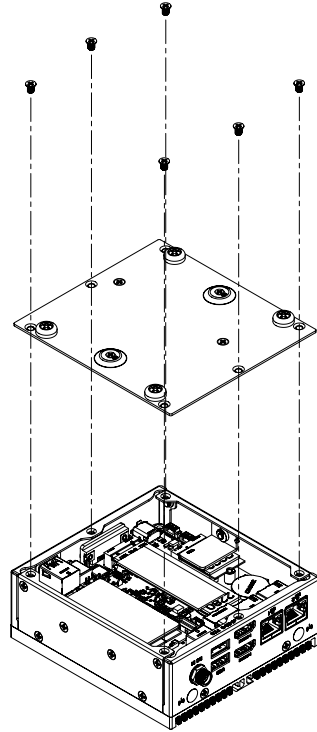

## [Bottom PCB Side]

Information	
A	1 x M.2 slot, 2280 M-key
B	1 x M.2 slot, 2230 E-key
C	1 x DDR5 SO-DIMM socket

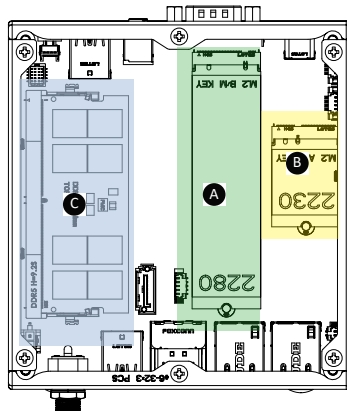

## 2.3 A) M.2 SSD Installation: How to safely install the M.2 2280 SSD

1

Remove the screw from the screw hole (Location : MSO2)

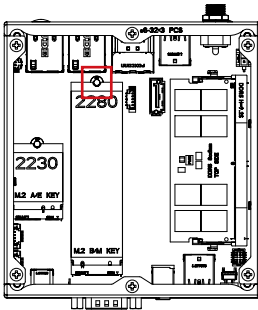

2

Carefully insert the M.2 SSD into the slot, and secure with the screw.

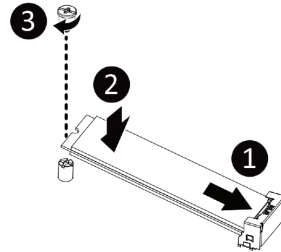

## 2.4 B) Wireless Module : How to safely install the Module (Wireless Module inclusion may vary based on local distribution)

---

1

Carefully insert the wireless module into the M.2 slot

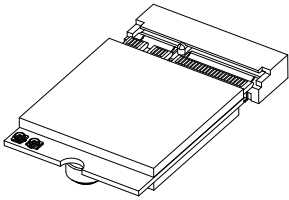

2

Lock the screw in the middle.

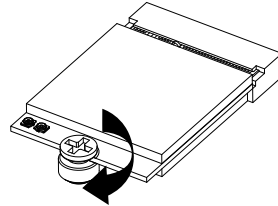

3

Install the antenna on the left side of the connection wireless module down.

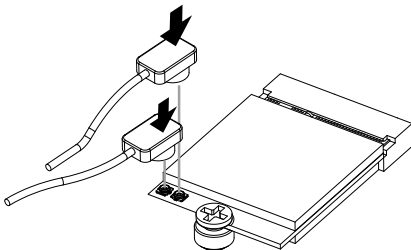

## 2.5 C) Memory Installation: DDR5 SO-DIMM

---

**1**

Carefully insert SO-DIMM memory modules.

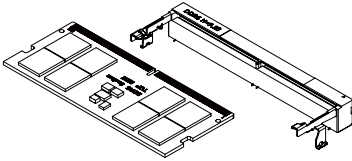
**2**

Push down until the modules click into place.

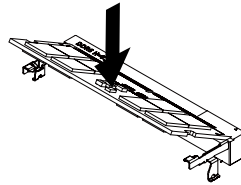
**3**

Make sure the module is completely installed.

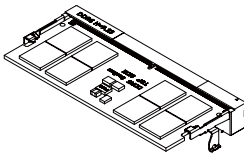

## 2.6 Antenna Installation (Antenna inclusion may vary based on local distribution)

---

1

Carefully insert the antennas into the connectors.

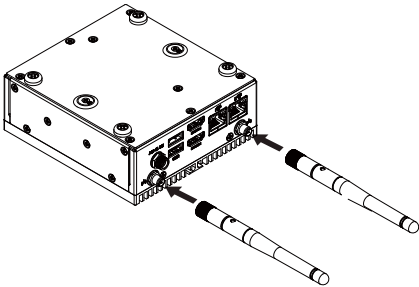

2

Turn the antennas clockwise until they are completely secure on the connectors.

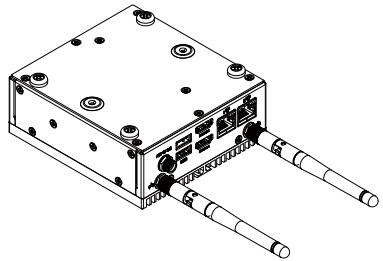

3

Flip up the antenna heads so that they are perpendicular to the machine.

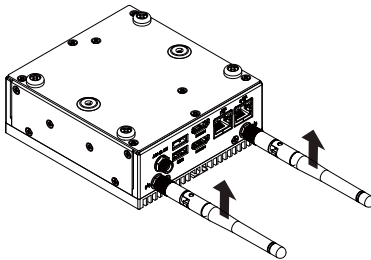

## 2.7 VESA Bracket

**1**

Attached the screws which provided with the QBiX.

Screws type : M3-3L x 2pcs

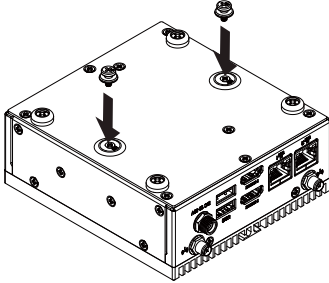

**2**

Attached the VESA mounting plate to the rear of a compatible display using the screws provided with the QBiX.

VESA hole patterns : 75 x 75mm and 100 x 100mm  
Screws type : M4-10L x 4pcs

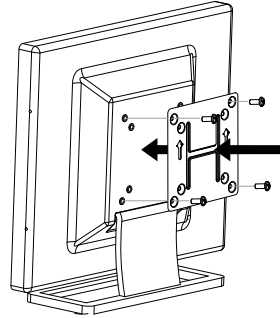

**3**

The QBiX can now be mounted by sliding the device into place.

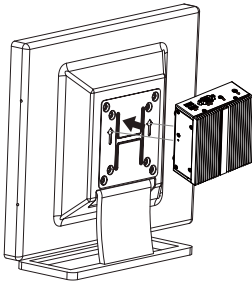

## 2.8 Support

---

- For a list of tested memory, M.2, wireless adapters and OS supported, go to: <http://www.gigaipc.com>
- To download the latest drivers and BIOS updates, go to: <http://www.gigaipc.com>
- For product support, go to: <http://www.gigaipc.com>



## 2.9 Safety and Regulatory Information

---

Risk of explosion if the battery is replaced with an incorrect type. Batteries should be recycled where possible.

Disposal of used Batteries must be in accordance with local environmental regulations.

Failure to use the included Power Adapter may violate regulatory compliance and may expose the user to safety hazards.

**HDMI**™  
HIGH DEFINITION MULTIMEDIA INTERFACE



At the end of its serviceable life, this product should not be treated as household or general waste. It should be handed over to the applicable collection point for the recycling of electrical and electronic equipment, or returned to the supplier for disposal.

# Chapter 3

---

## Chapter 3 – BIOS

## 3.1 Introduction

BIOS (Basic input/output system) provides hardware detailed information and boot-up options, which include firmware to control, set-up and test all hardware settings. Therefore, BIOS is the communication bridge between OS/application software and hardware.

### 3.1.1 How to Entering into BIOS menu

Once the system is power on, press the <DEL> key as soon as possible to access into BIOS Setup program.

### 3.1.2 Function Keys to setup in BIOS Setup program

Function keys	Description
→←	Select Screen
↑↓	Select Item
Enter	Execute command or enter the submenu
+	Increase the numeric value or make changes
—	Decrease the numeric value or make changes
F1	General Help
F2	Previous Values
F3	Load Optimized Defaults Settings
F4	Save changes & Exit the BIOS Setup program
ESC	Exit the BIOS Setup program

## 3.2 The Main Menu

The main menu shows the basic system information. Use arrow keys to move among the items.

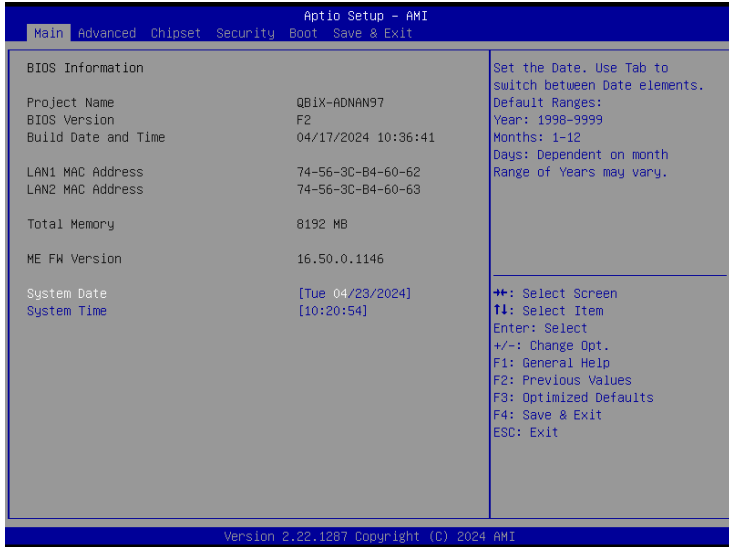

Items	Description
<b>Project Name</b>	<b>Shows Project name information</b>
<b>BIOS Version</b>	<b>Shows the BIOS version of the system</b>
<b>Build Date and Time</b>	<b>Shows the Build Date and Time when the BIOS was created.</b>
<b>LAN1 MAC Address</b>	<b>Shows LAN1 MAC Address information</b>
<b>LAN2 MAC Address</b>	<b>Shows LAN2 MAC Address information</b>
<b>Total Memory</b>	<b>Shows the total memory size of the installed memory</b>
<b>ME FW version</b>	<b>Shows ME firmware version</b>
<b>System Date</b>	<b>Set the Date for the system (Format : Week - Month - Day - Year)</b>
<b>System Time</b>	<b>Set the time for the system (Format : Hour - Minute - Second)</b>

### 3.3 Advanced

The Advanced menu is to configure the functions of hardware settings through submenu. Use arrow keys to move among the items, and press <Enter> to access into the related submenu.

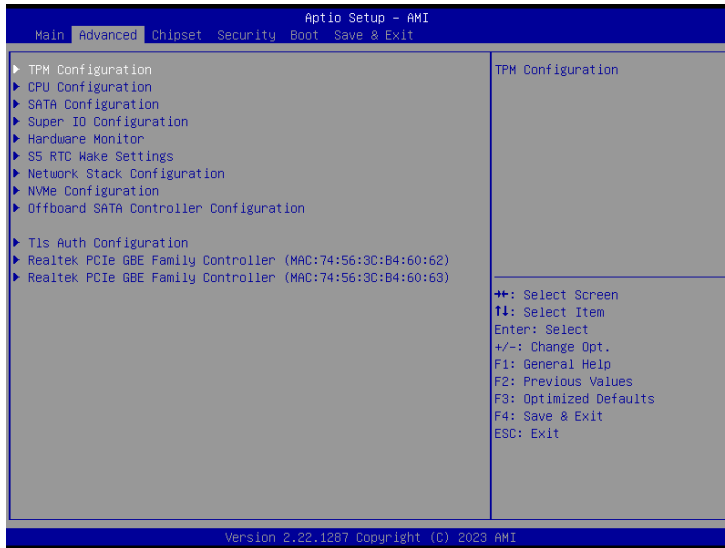

### 3.3.1 TPM Configuration

Use TPM Configuration submenu to choose TPM interface.

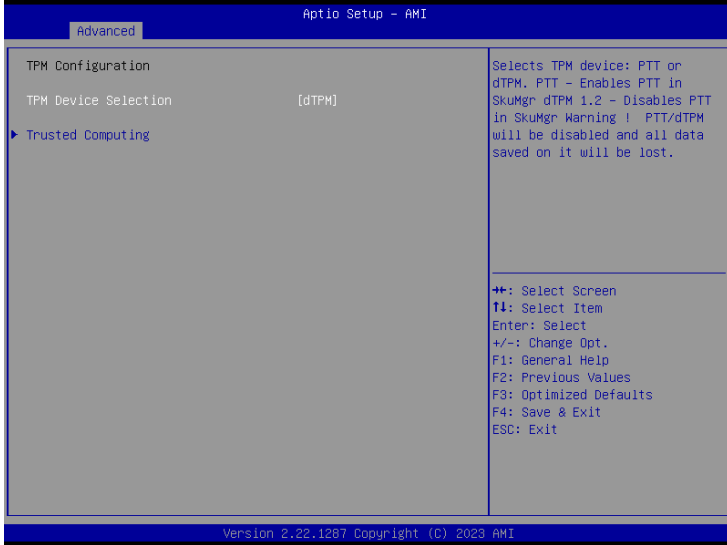

Item	Description
<b>TPM Device Selection</b>	<b>PTT : Internal TPM</b> <b>dTPM : External TPM (When using External TPM module or having TPM chip on MB)(Default setting)</b>

Trusted Computing : Shows TPM information, and TPM module configuration setting.



Item	Description
<b>Security Device support</b>	<b>Enabled : Enables TPM feature (Default setting)</b> <b>Disabled : Disables TPM feature</b>
<b>Pending operation</b>	<b>None : No execution will be conducted (Default setting)</b> <b>TPM clear : Set to clear data on TPM</b>

### 3.3.2 CPU Configuration

This submenu shows detailed CPU informations.

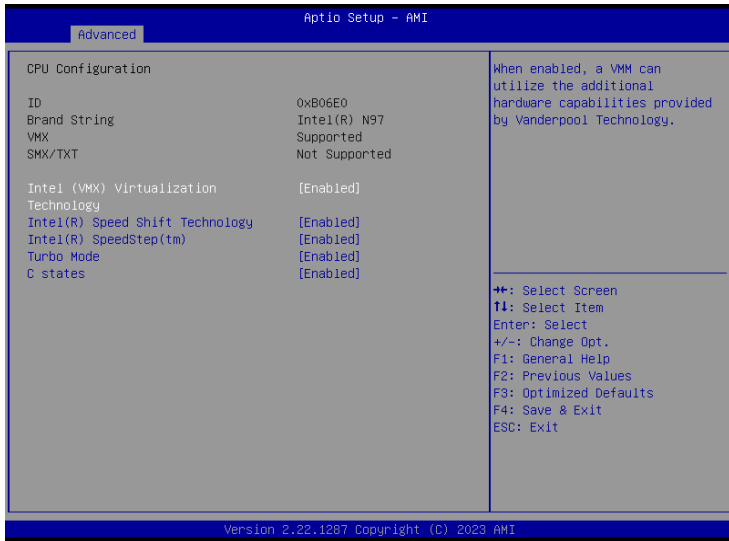

Item	Description
<b>Intel (VMX) Virtualization Technology</b>	Virtualization enhanced by Intel® Virtualization Technology will allow a platform to run multiple operating systems and applications in independent partitions. With virtualization, one computer system can function as multiple virtual systems. <b>Enabled : Enables Intel Virtualization Technology (Default setting)</b> <b>Disabled : Disables Intel Virtualization Technology</b>
<b>Intel® Speed Shift Technology</b>	<b>Enabled : Enables Intel® Speed Shift Technology (Default setting)</b> <b>Disabled : Disables Intel® Speed Shift Technology</b>
<b>Intel® Speedstep™</b>	<b>Enabled : Enables Intel® Speedstep™ (Default setting)</b> <b>Disabled : Disables Intel® Speedstep™</b>
<b>Turbo Mode</b>	<b>Enabled : Enables Turbo Mode (Default setting)</b> <b>Disabled : Disables Turbo Mode</b>
<b>C states</b>	Command CPU to enter into low power consumption mode when CPU is under idle mode. <b>Enabled : Enables CPU C states function (Default setting)</b> <b>Disabled : Disables CPU C states function</b>



### 3.3.3 SATA Configuration

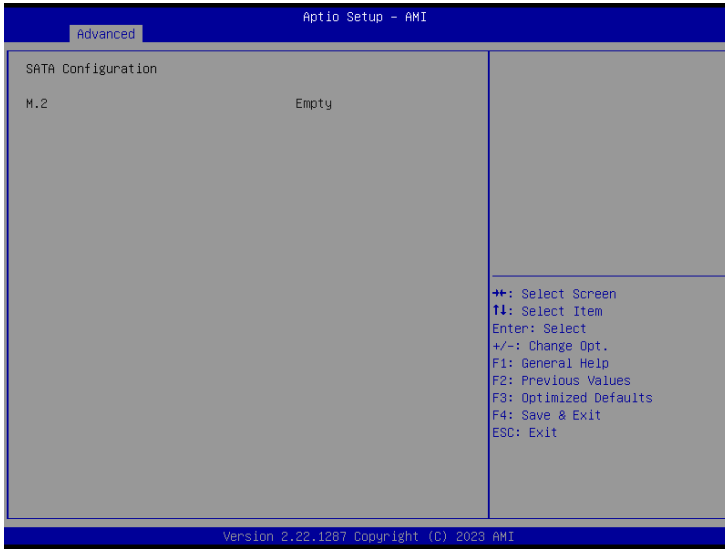

Item	Description
<b>M.2</b>	shows M.2 SATA interface SSD information

### 3.3.4 Super IO Configuration

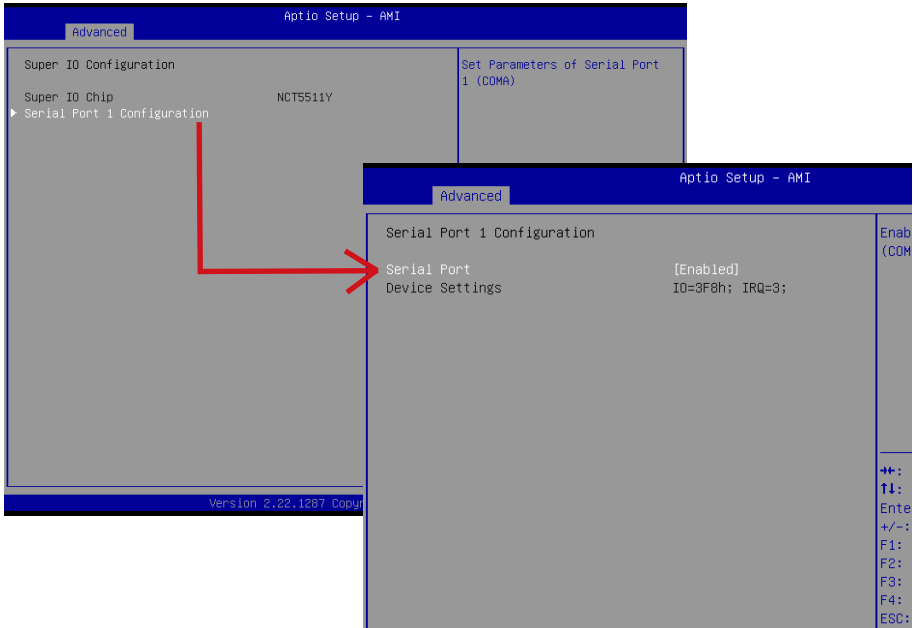

Item	Description
<b>Super IO Chip</b>	Shows Super I/O chip model
<b>Serial Port 1 Configuration</b>	Press [Enter] to configure advanced items :  Enable or Disable Serial Port <b>Enabled : Enables Serial Port function (Default setting)</b> <b>Disabled : Disables Serial Port function</b>  Device settings : Display the specified Serial Port base I/O address and IRQ

### 3.3.5 Hardware Monitor

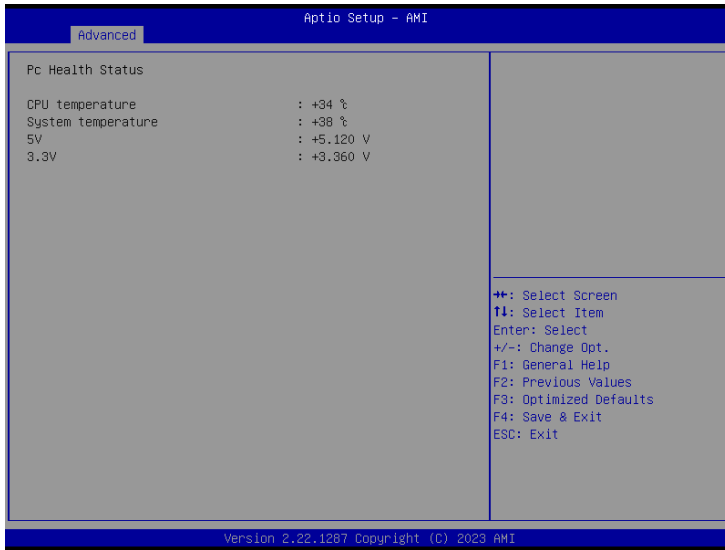

Item	Description
<b>CPU Temperature</b>	Shows current CPU temperature
<b>System Temperature</b>	Shows current system temperature

### 3.3.6 S5 RTC Wake Settings



Item	Description
Wake system from S5	<p>Enable or Disable System to wake on a specific time.</p> <p><b>Disabled : Disables system to wake on a specific time (Default setting)</b></p> <p><b>Fixed Time : Enables system to wake on a specific time (Format : hr : min : sec)</b></p>

### 3.3.7 Network Stack Configuration-1

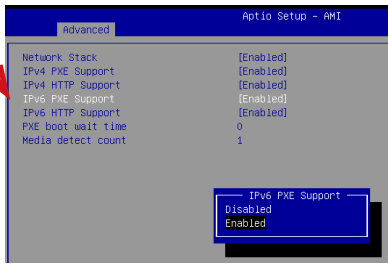
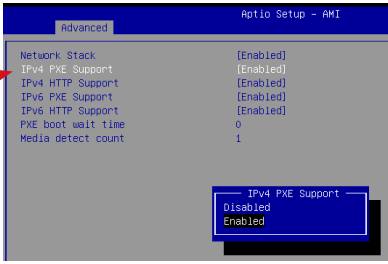
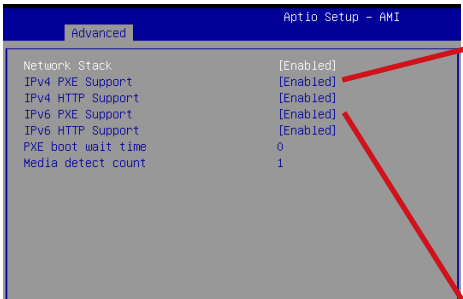
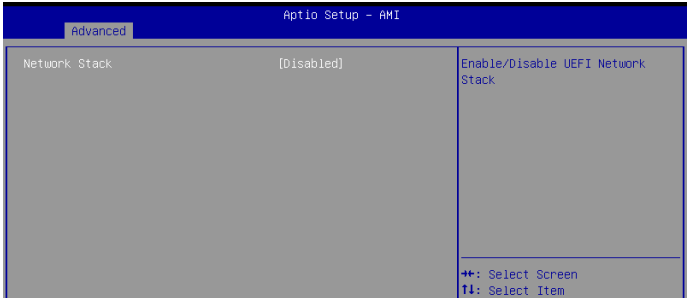

Item	Description
<b>Network Stack</b>	When system is power on, install LAN driver under UEFI mode <b>Disabled : Disables UEFI Network Stack (Default setting)</b> <b>Enabled : Enables UEFI Network Stack</b>
<b>IPv4 PXE Support</b>	When Network stack is enabled : <b>Disabled : Disables Ipv4 PXE Support</b> <b>Enabled : Enables Ipv4 PXE Support (Default setting)</b>
<b>IPv6 PXE Support</b>	When Network stack is enabled : <b>Disabled : Disables Ipv6 PXE Support</b> <b>Enabled : Enables Ipv6 PXE Support (Default setting)</b>

## 3.3.7 Network Stack Configuration-2

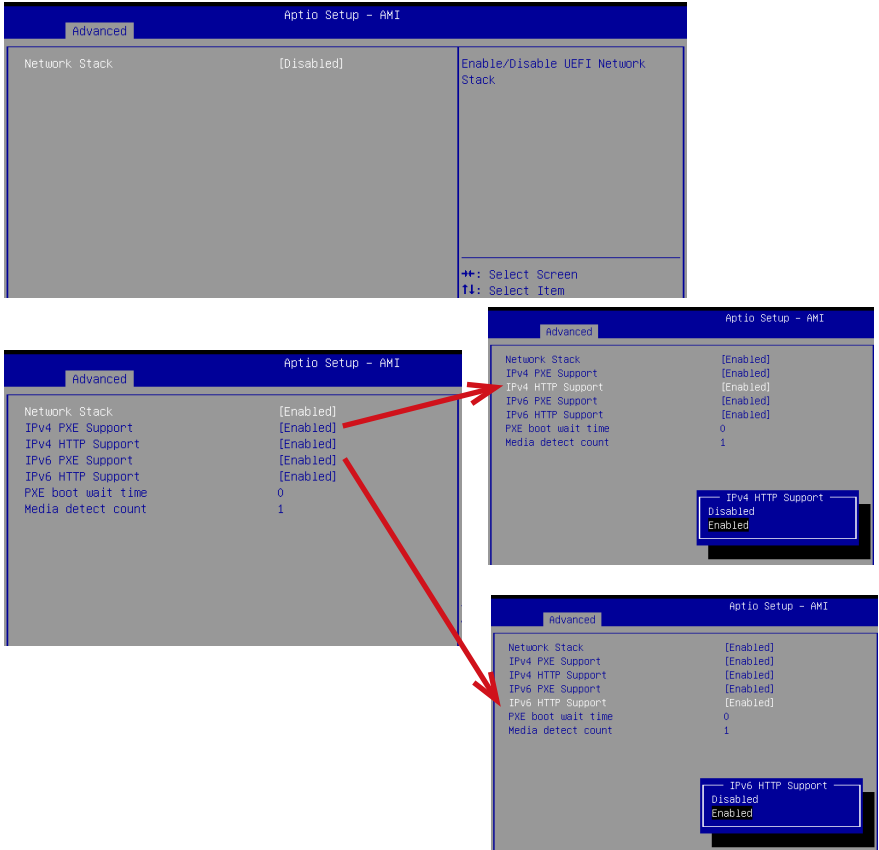

Item	Description
<b>Network Stack</b>	When system is power on, install LAN driver under UEFI mode <b>Disabled : Disables UEFI Network Stack (Default setting)</b> <b>Enabled : Enables UEFI Network Stack</b>
<b>IPv4 HTTP Support</b>	When Network stack is enabled : <b>Disabled : Disables Ipv4 HTTP Support</b> <b>Enabled : Enables Ipv4 HTTP Support (Default setting)</b>
<b>IPv6 HTTP Support</b>	When Network stack is enabled : <b>Disabled : Disables Ipv6 HTTP Support</b> <b>Enabled : Enables Ipv6 HTTP Support (Default setting)</b>

### 3.3.8 NVMe Configuration

---

NVMe Configuration shows information when your M.2 NVMe PCIe SSD is installed.

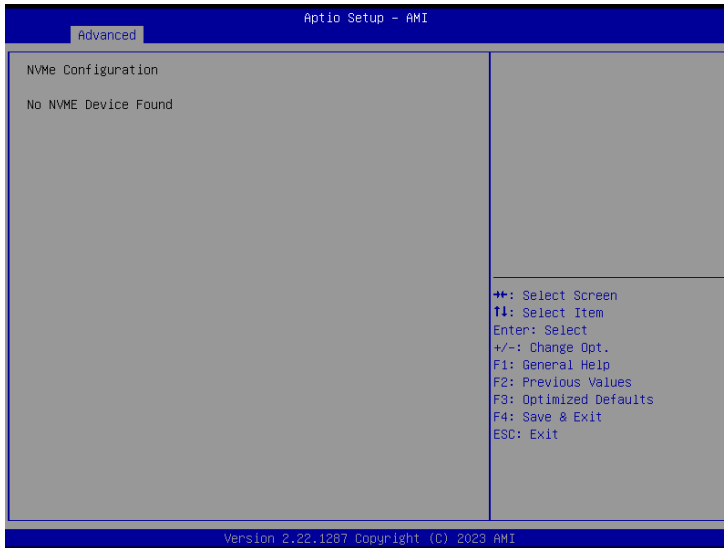

### 3.3.9 Offboard SATA Controller Configuration





### 3.3.10 Tls Auth Configuration

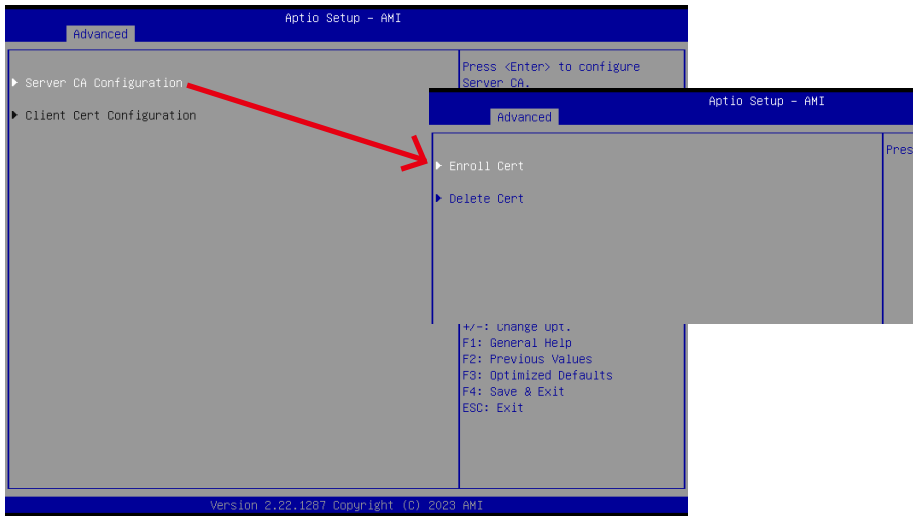

Item	Description
<p><b>Enroll Cert</b></p>	<p>Press [Enter] to configure advanced items :</p> <p><b>Server CA Configuration :</b></p> <p>Enroll Cert :</p> <ol style="list-style-type: none"> <li>1. Enroll Cert Using File</li> <li>2. Cert GUID : Input digit character in 11111111-2222-3333-4444-1234567 890ab format.</li> <li>3. Commit Changes and Exit</li> <li>4. Discard Changes and Exit</li> </ol>

### 3.3.11 Realtek PCIe GBE Family Controller (MAC:74:56:3C:B4:60:62) (MAC address may varied based on different motherboard)

Shows Realtek Ethernet controller information

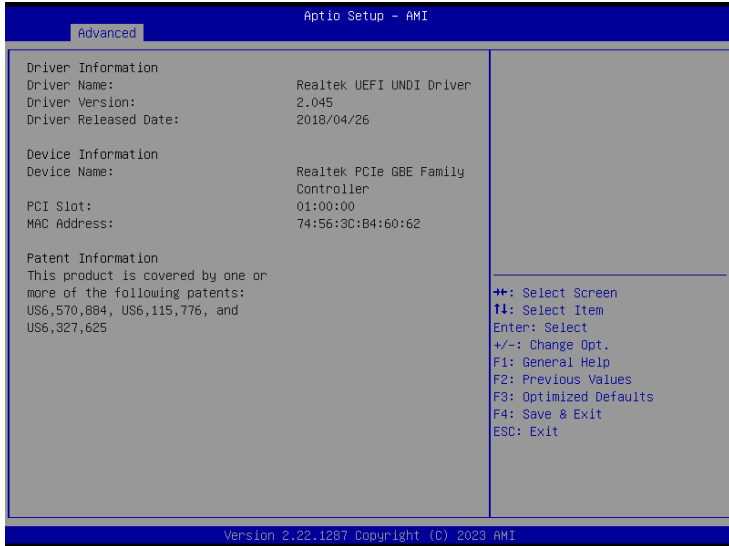

NOTE : MAC address may varied based on different motherboard

### 3.3.12 Realtek PCIe GBE Family Controller (MAC:74:56:3C:B4:60:63) (MAC address may varied based on different motherboard)

Shows Realtek Ethernet controller information

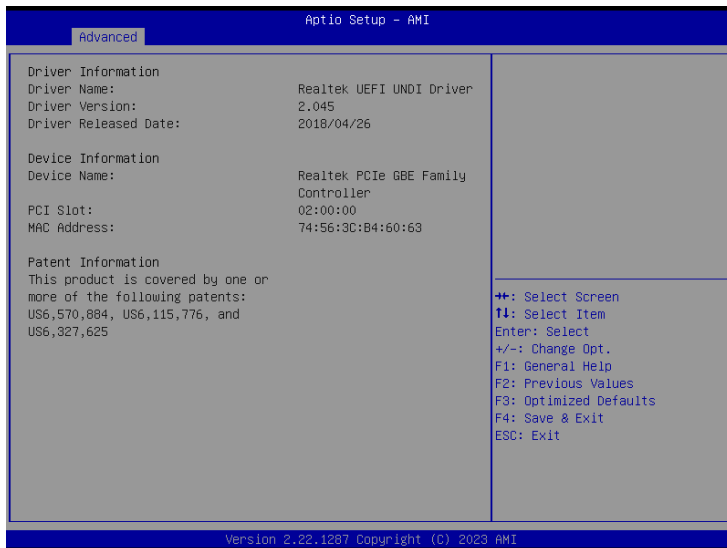

NOTE : MAC address may varied based on different motherboard

## 3.4 Chipset

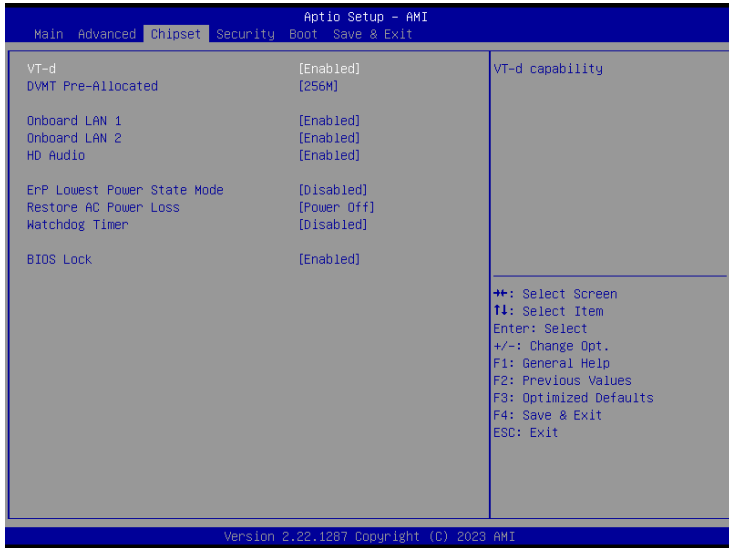

Item	Description
<b>VT-d</b>	<b>Enabled</b> : Enables VT-d function (Default setting) <b>Disabled</b> : Disables VT-d function
<b>DVMT Pre-Allocated</b>	Use DVMT Pre-Allocated to set the amount of system memory which is installed to the integrated graphics processor <b>Option items</b> : 32M , 64M, 128M, 256M (Default setting)
<b>Onboard LAN1 Onboard LAN2</b>	Enable/Disable onboard LAN controller <b>Enabled</b> : Enables onboard LAN controller (Default setting) <b>Disabled</b> : Disables onboard LAN controller
<b>HD Audio</b>	Enable/Disable onboard audio controller <b>Enabled</b> : Enables onboard audio controller (Default setting) <b>Disabled</b> : Disables onboard audio controller
<b>ErP Lowest Power State Mode</b>	Enable/Disable Enables ErP Lowest Power State Mode <b>Enabled</b> : Enables ErP Lowest Power State Mode <b>Disabled</b> : Disables ErP Lowest Power State Mode (Default setting)
<b>Restore AC Power Loss</b>	To set which option the system should returns if a sudden power loss occurred <b>Power off</b> : Do not power on when the power is back (Default setting) <b>Power on</b> : System power on when the power is back <b>Last state</b> : Restore the system to the state before power loss occurs
<b>Watchdog Timer</b>	Enable/Disable Watchdog Timer function <b>Enabled</b> : Enables Watchdog Timer function <b>Disabled</b> : Disabled Watchdog Timer function (Default setting)
<b>BIOS Lock</b>	Enable/Disable BIOS Lock function <b>Enabled</b> : Enables BIOS Lock function (Default setting) <b>Disabled</b> : Disabled BIOS Lock funtion

## 3.5 Security



Item	Description
<b>Administrator Password</b>	To set up Administrator's password <b>Minimum length : 3</b> <b>Maximum length : 20</b>
<b>User Password</b>	To set up User's password <b>Minimum length : 3</b> <b>Maximum length : 20</b>
<b>Secure Boot</b>	Press <Enter> to configure the advanced items

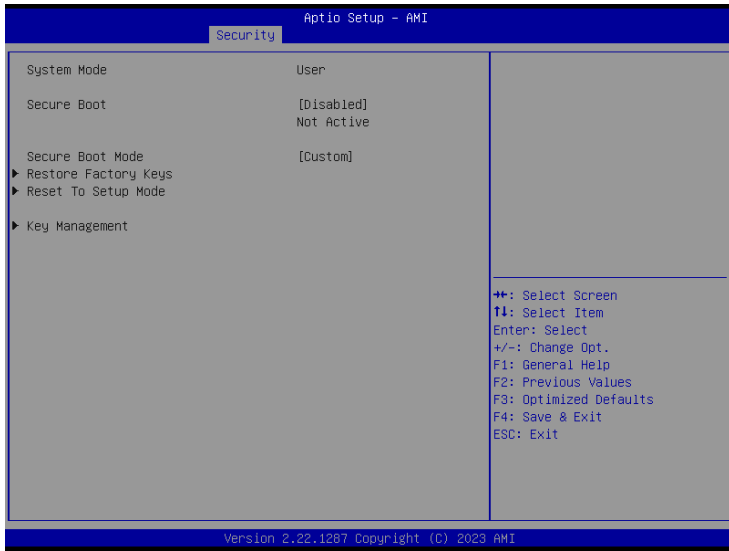

Item	Description
Secure Boot	Secure Boot requires all the applications that are running during the booting process to be pre-signed with valid digital certificates <b>Enabled : Enables Secure Boot function</b> <b>Disabled : Disables Secure Boot function (Default setting)</b>
Secure Boot Mode	<b>Standard : Standard mode</b> <b>Custom : Custom mode (Default setting)</b>
Restore Factory Keys	To restore factory settings <b>Yes : Agree to restore factory settings</b> <b>No : Cancel to restore factory settings</b>
Reset To Setup Mode	<b>Yes : Agree to setup mode</b> <b>No : Cancel to setup mode</b>
Key Management	Enables expert users to modify Secure boot policy variables without full authentication Press <Enter> to configure the advanced items

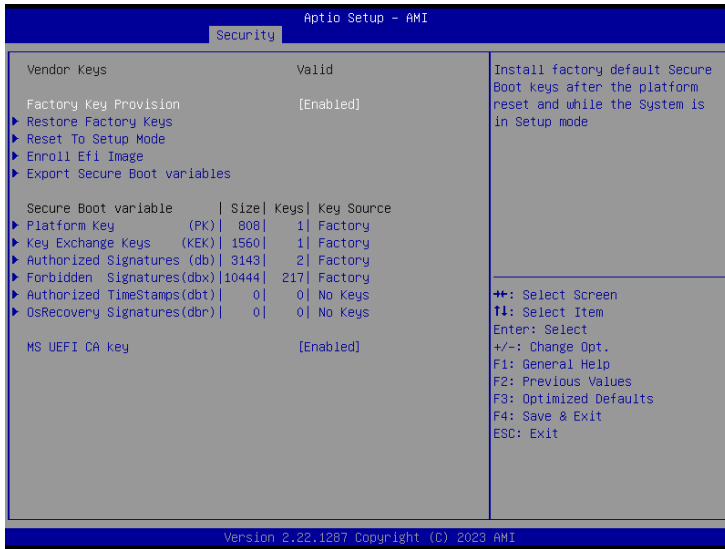

Item	Description
<b>Factory Key Provision</b>	Install factory default Secure Boot keys after the platform reset and while the system is in Setup mode <b>Enabled : Enables Factory Key Provision (Default setting)</b> <b>Disabled : Disables Factory Key Provision</b>
<b>Restore Factory Keys</b>	To restore factory settings
<b>Reset To Setup Mode</b>	Delete all Secure boot key databases from NVRAM
<b>Enroll Efi Image</b>	Allow the image to run in Secure Boot mode
<b>Export Secure Boot variables</b>	Copy NVRAM content of Secure Boot variables to files in a root folder on a file system device

Item	Description
<b>Platform Key (PK)</b>	These items allows you to enroll factory defaults or load Certificates from a file.
<b>Key Exchange Keys (KEK)</b>	
<b>Authorized Signatures (db)</b>	
<b>Forbidden Signatures (dbx)</b>	
<b>Authorized TimeStamps (dbt)</b>	
<b>OsRecovery Signatures (dbr)</b>	
<b>MS UEFI CA key</b>	<b>Enabled : Enables MS UEFI CA Key (Default setting)</b> <b>Disabled : Disables MS UEFI CA Key</b>

### 3.6 Boot

This Boot menu allows you to set/change system boot options



Item	Description
<b>Full Screen LOGO Show</b>	Enable/Disable full screen LOGO show on POST screen <b>Enabled : Enables Full screen LOGO Show on POST screen</b> <b>Disabled : Disables Full screen LOGO Show on POST screen (Default setting)</b>
<b>Built-in EFI Shell</b>	<b>Enabled : Enables Built-in EFI Shell</b> <b>Disabled : Disables Built-in EFI Shell (Default setting)</b>
<b>Boot Option #1</b>	Shows the information of the storage that be installed in the system <b>Choose/set the boot priority</b>



## 3.7 Save & Exit

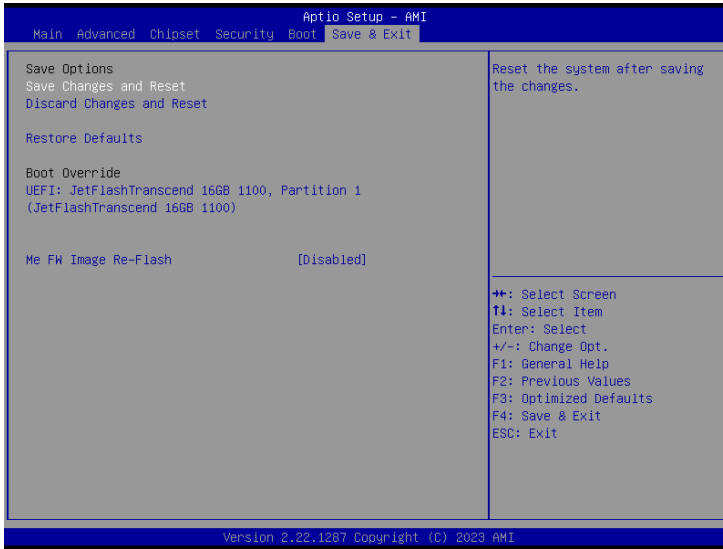

Item	Description
<b>Save Changes and Reset</b>	After configuring all the options that you wish to change, choose this option to save all the changes and reboot the system <b>Yes : Agree to save and reset</b> <b>No : Cancel to save and reset</b>
<b>Discard Changes and Reset</b>	Choose this option to reboot the system without saving any changes <b>Yes : Agree to discard changes and reset</b> <b>No : Cancel to discard changes and reset</b>
<b>Restore Defaults</b>	Restore/Load default values for all the setup options <b>Yes : Agree to load optimized defaults</b> <b>No : Cancel to load optimized defaults</b>
<b>Me FW Image Re-Flash</b>	Enable/Disable Me FW image re-flash function <b>Enabled : Enables Me FW image re-flash function</b> <b>Disabled : Disables Me FW image re-flash function (Default setting)</b>