

QBiX-Plus-EHLA6412-A1 (QS-6412A-SI)

Industrial Embedded System
Quick Start Guide

Copyright Notice

This document is copyrighted, 2022. All rights are reserved. The original manufacturer reserves the right to make improvements to the products described in this manual at any time without notice.

No part of this manual may be reproduced, copied, translated, or transmitted in any form or by any means without the prior written permission of the original manufacturer. Information provided in this manual is intended to be accurate and reliable. However, the original manufacturer assumes no responsibility for its use, or for any infringements upon the rights of third parties that may result from its use.

The material in this document is for product information only and is subject to change without notice. While reasonable efforts have been made in the preparation of this document to assure its accuracy, Beijer assumes no liabilities resulting from errors or omissions in this document, or from the use of the information contained herein.

GIGAIPC reserves the right to make changes in the product design without notice to its users.

Acknowledgement

All other products' name or trademarks are properties of their respective owners.

- AMD is trademark of Advanced Micro Devices.
- Microsoft Windows is a registered trademark of Microsoft Corp.
- Intel, Pentium, Celeron, and Xeon are registered trademarks of Intel Corporation
- Core, Atom are trademarks of Intel Corporation
- ITE is a trademark of Integrated Technology Express, Inc.
- IBM, PC/AT, PS/2, and VGA are trademarks of International Business Machines Corporation.

All other product names or trademarks are properties of their respective owners.

Packing List

Before setting up your product, please make sure the following items have been shipped:

Item	Quantity
System	1
Power Cord : Optional (by region)	1
PSU ADP 19V 65W 100-240VAC (P/N: 25EP2-10065U-A3S)	1
RJ45 to D-SUB Cable #24 150mm (P/N: 25CR0-150400-S9R)	1
VESA Mount Bracket (P/N: 25HB1-TPL021-S8R)	1
VESA Mount screws (P/N: 25KSD-000002-COR)	1

If any of these items are missing or damaged, please contact your distributor or sales representative immediately.

About this Document

This User's Manual contains all the essential information, such as detailed descriptions and explanations on the product's hardware and software features (if any), its specifications, dimensions, jumper/connector settings/definitions, and driver installation instructions (if any), to facilitate users in setting up their product.

Safety Precautions

Please read the following safety instructions carefully. It is advised that you keep this manual for future references

1. All cautions and warnings on the device should be noted.
2. Make sure the power source matches the power rating of the device.
3. Position the power cord so that people cannot step on it. Do not place anything over the power cord.
4. Always completely disconnect the power before working on the system's hardware.
5. No connections should be made when the system is powered as a sudden rush of power may damage sensitive electronic components.
6. If the device is not to be used for a long time, disconnect it from the power supply to avoid damage by transient over-voltage.
7. Always disconnect this device from any AC supply before cleaning.
8. While cleaning, use a damp cloth instead of liquid or spray detergents.
9. Make sure the device is installed near a power outlet and is easily accessible.
10. Keep this device away from humidity.
11. Place the device on a solid surface during installation to prevent falls
12. Do not cover the openings on the device to ensure optimal heat dissipation.

13. Watch out for high temperatures when the system is running.
14. Do not touch the heat sink or heat spreader when the system is running
15. Never pour any liquid into the openings. This could cause fire or electric shock.
16. As most electronic components are sensitive to static electrical charge, be sure to ground yourself to prevent static charge when installing the internal components. Use a grounding wrist strap and contain all electronic components in any static-shielded containers.
17. If any of the following situations arises, please the contact our service personnel:
 - i. Damaged power cord or plug
 - ii. Liquid intrusion to the device
 - iii. Exposure to moisture
 - iv. Device is not working as expected or in a manner as described in this manual
 - v. The device is dropped or damaged
 - vi. Any obvious signs of damage displayed on the device
- 18. DO NOT LEAVE THIS DEVICE IN AN UNCONTROLLED ENVIRONMENT WITH TEMPERATURES BEYOND THE DEVICE'S PERMITTED STORAGE TEMPERATURES (SEE CHAPTER 1) TO PREVENT DAMAGE.**

FCC Statement

Warning!



This device complies with Part 15 FCC Rules. Operation is subject to the following two conditions: (1) this device may not cause harmful interference, and (2) this device must accept any interference received including interference that may cause undesired operation.

Caution:

There is a danger of explosion if the battery is incorrectly replaced. Replace only with the same or equivalent type recommended by the manufacturer. Dispose of used batteries according to the manufacturer's instructions and your local government's recycling or disposal directives.

Attention:

Il y a un risque d'explosion si la batterie est remplacée de façon incorrecte. Ne la remplacer qu'avec le même modèle ou équivalent recommandé par le constructeur. Recycler les batteries usées en accord avec les instructions du fabricant et les directives gouvernementales de recyclage.

High Temperature Warning

(1) This equipment is intended to be used in Restrict Access Location. The access can only be gained by Skilled person or by Instructed person who have been instructed about the metal chassis of the equipment is so hot that Skilled person have to pay special attention or take special protection. Only authorized by well trained professional person can access the restrict access location.



(2) External metal parts are hot!! Before touching it, special attention or protection is necessary

Table Contents

Industrial Embedded System	1
Quick Start Guide	
Copyright Notice	2
Acknowledgement	3
Packing List.....	4
About this Document.....	5
Safety Precautions	6
FCC Statement.....	8
High Temperature Warning	8
Chapter 1 - Product Specifications	12
1.1 Specifications	14
Chapter 2 – QBiX-Plus-EHLA6412-A1 (QS-6412A-SI)	16
2.1 Dimension	17
2.2 Getting Familiar with Your Unit.....	18
2.3 A) Wireless Module : How to safely install the Module (Wireless Module inclusion may vary based on local distribution)	21
2.4 B) 5G module Installation: How to safely install the module (5G Module inclusion may vary based on local distribution).....	22
2.5 C) M.2 SSD Installation: How to safely install the M.2 2280 SSD	23

2.6	D) Memory Installation: DDR4 SO-DIMM	24
2.7	Antenna Installation (Antenna inclusion may vary based on local distribution)	25
2.8	VESA Bracket Installation	26
2.9	Safety and Regulatory Information.....	27

Chapter 3 – Motherboard Pin Define 28

3.1	Jumpers and Connectors	29
3.2.1	FAN (FAN connector)	31
3.2.2	DC_IN (DC Jack connector)	32
3.2.3	HDMI1, HDMI2 (HDMI connector)	33
3.2.4	USB3_1 (USB 3.2 Gen 1 connector)	34
3.2.5	LAN1, LAN2 (LAN connector).....	35
3.2.6	HP (Headphone Jack)	36
3.2.7	SODIMMA1, SODIMMB1 (DDR4 SO-DIMM Slot)	36
3.2.8	BATTERY1 (Battery cable connector).....	37
3.2.9	M2B (M.2 Slot, B-Key, NGFF 3042).....	38
3.2.10	M2M (M.2 Slot, M-Key, NGFF 2280)	39
3.2.11	M2E (M.2 Slot, E-key, NGFF 2230)	40
3.2.12	PWR_BTN (Power button with LED)	41
3.2.13	HDMI3 (HDMI connector)	42
3.2.14	RJ45_COM (Serial Port (RS-232)(RJ45 type))	43
3.2.15	USB3_2 (USB 3.2 Gen 1 connector)	44

Chapter 4 – BIOS**45**

4.1	Introduction	46
4.2	The Main Menu.....	47
4.3	Advanced	48
4.3.1	TPM Configuration.....	49
4.3.2	S5 RTC Wake Settings	51
4.3.3	CPU Configuration	52
4.3.4	SATA Configuration	53
4.3.5	Super IO Configuration	54
4.3.6	Hardware Monitor	55
4.3.7	Network Stack Configuration.....	56
4.3.8	NVMe Configuration.....	57
4.3.9	Offboard SATA Controller Configuration	58
4.4	Chipset	59
4.5	Security	60
4.6	Boot.....	63
4.7	Save & Exit	64

Chapter 1

Chapter 1 - Product Specifications

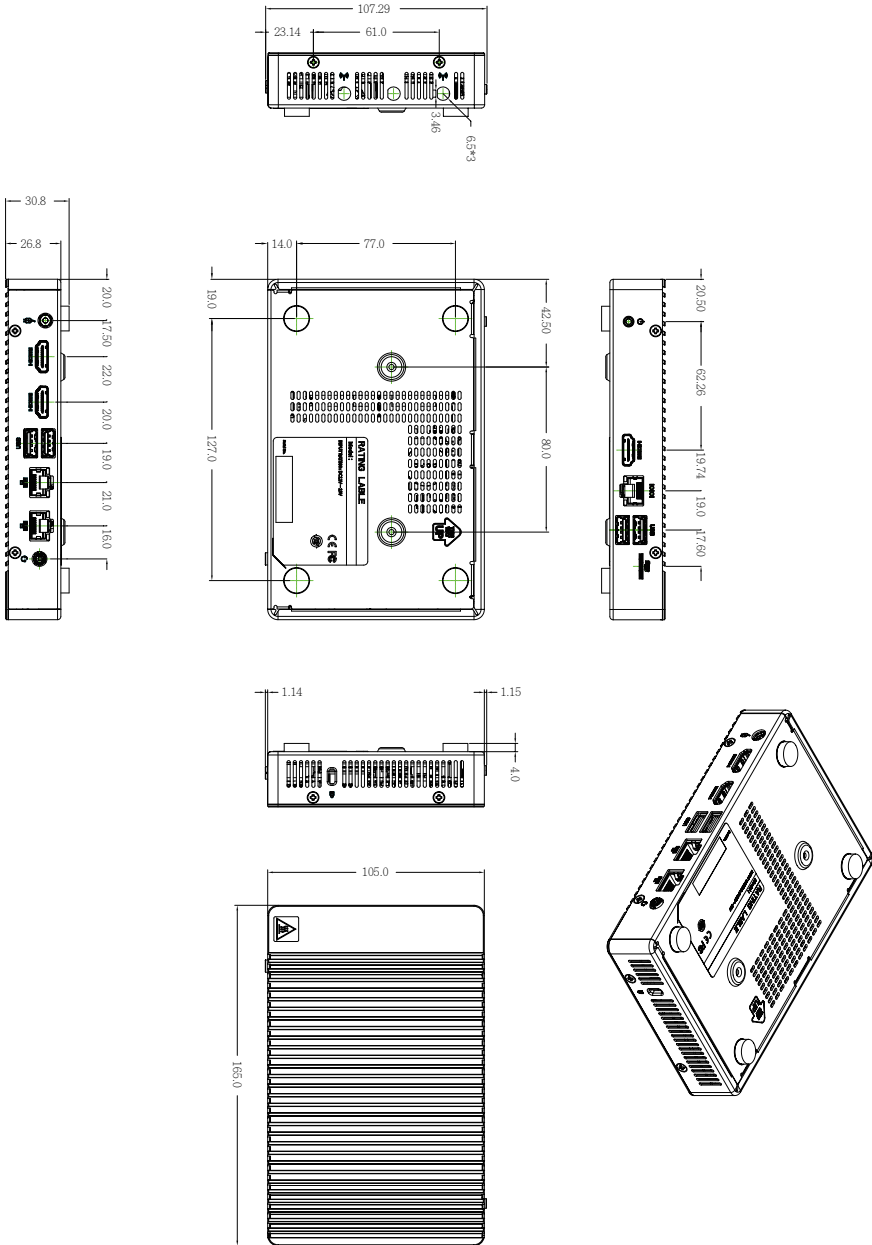

1.1 Specifications

System	QBiX-Plus-EHLA6412-A1 (QS-6412A-SI)
Dimension	System Size : 165W x 105D x 27H (mm)
CPU	Intel® Celeron® J6412 Processor 10nm, 4 cores, 4 threads, up to 2.60 GHz TDP 10W
Memory	2 x DDR4 SO-DIMM sockets, Max. Capacity 32 GB Support Dual Channel DDR4 3200 MHz memory modules
Ethernet	2 x GbE LAN Ports
Graphic support	Integrated Graphics Processor - Intel® UHD Graphics for 10th Gen Intel® Processors: 3 x HDMI 2.0 port, supporting a maximum resolution of 4096x2160 @60Hz (3 independent display outputs)
Audio	Realtek® Audio Codec
Storage	—
Expansion Slots	1 x 2280 M.2 M-Key (PCIe x2, SATA 6Gb/s) 1 x 2230 M.2 E-Key 1 x 3042 M.2 B-key (USB 3.2 Gen 1)
Front I/O	2 x USB 3.2 Gen 1 1 x COM Port (RS-232)(RJ45 Type) 1 x Micro SD card slot 1 x Power button 1 x HDMI
Rear I/O	1 x Headphone Jack 2 x RJ45 LAN Ports 2 x USB 3.2 Gen 1 2 x HDMI 1 x DC Jack
Side I/O	3 x External Antenna Holes (Optional)
Power	+12~19VDC (Adapter 19V/65W)
Operation temperature	Operating temperature: 0°C to 50°C Operating humidity: 0-90% (non-condensing) Non-operating temperature: -40°C to 85°C Non-operating humidity: 0%-95% (non-condensing)

System	QBiX-Plus-EHLA6412-A1 (QS-6412A-SI)
Vibration During Operation	Operation: IEC 60068-2-64, 3 Grms, random, 5 ~ 500 Hz, 1 hr / Per Axis, With SSD/M.2 2280 Non-operation: IEC 60068-2-6, 2 G, Sine, 10 ~ 500 Hz, 1 Oct/min, 1 hr / Per Axis
Shock During Operation	Operation: IEC 60068-2-27, 50 G, half sine, 11 ms duration, With SSD
Packaging Content	Carton size: 416 x 359 x 257 (mm) Packing Capacity: 10pcs Including: Power Cord : Optional (by region) PSU ADP 19V 65W 100-240VAC x 1 (P/N: 25EP2-10065U-A3S) RJ45 to D-SUB Cable #24 150mm x 1 (P/N: 25CR0-150400-S9R) VESA Mount Bracket x 1 (P/N: 25HB1-TPL021-S8R) VESA Mount screws x 1 (P/N: 25KSD-000002-C0R)
Order Information	System: 6BQS6412AMR-SI (Box packing)

Chapter 2

Chapter 2 – QBiX-Plus-EHLA6412-A1 (QS-6412A-SI)

2.1 Dimension

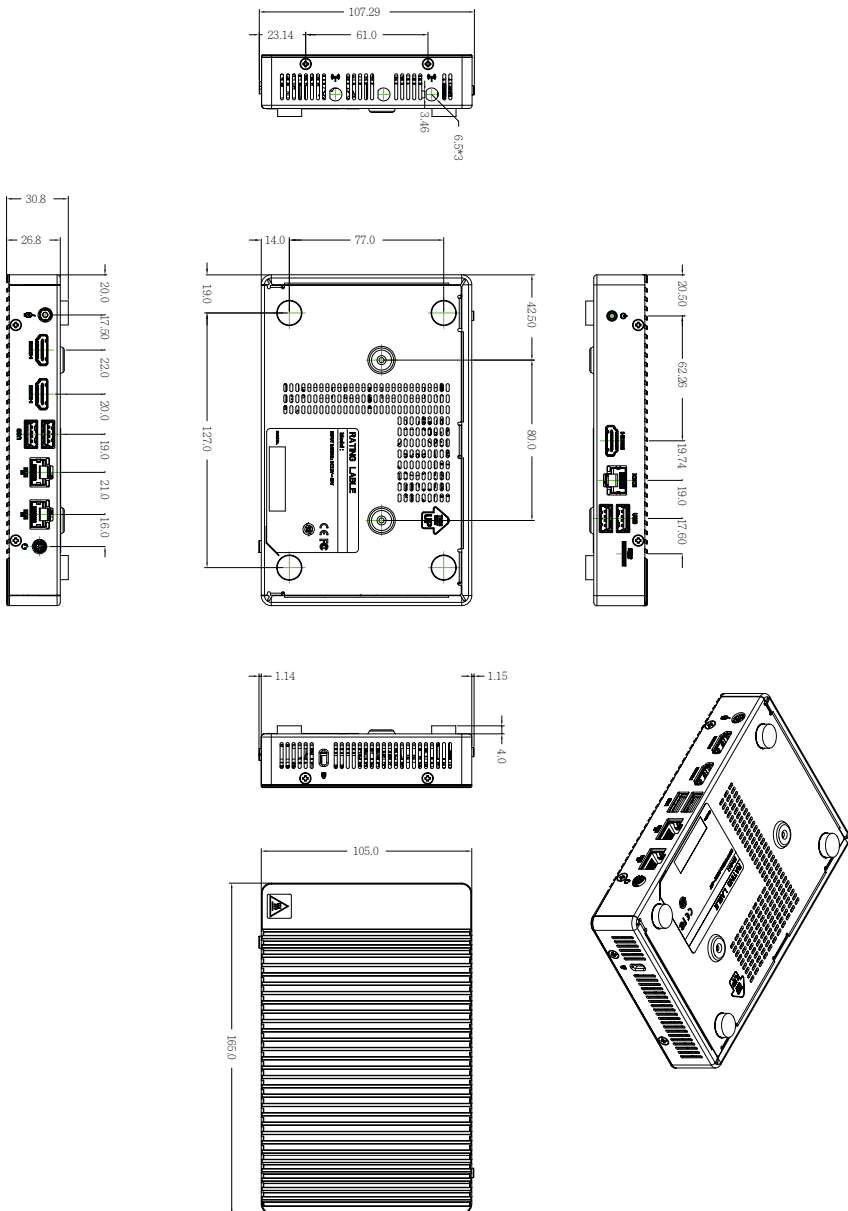

2.2 Getting Familiar with Your Unit

[Rear I/O Port on Board]

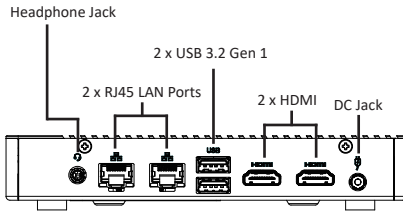

[Left side]

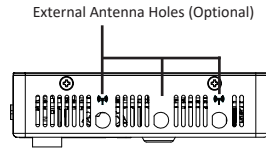

[Front Side]

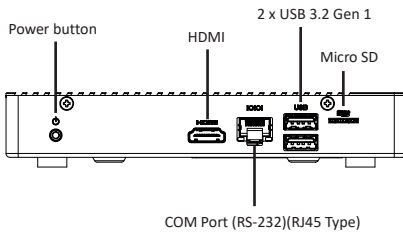

[Right Side]

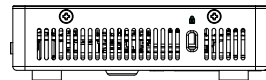

[Installation]

- * Before opening the case, make sure to unplug the power cord.
- * 打開機殼前，請確實移除電源。
- * Before Connecting the power, make sure to fasten the case securely.
- * 接上電源前，請確實將機殼完整鎖附。

1

Loosen 2 screws on the rear IO side to open the chassis.

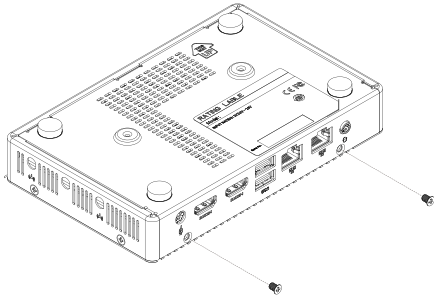

2

Follow below direction to push the bottom cover. (*Caution : Stop pushing the bottom cover when the slide rail appeared.)

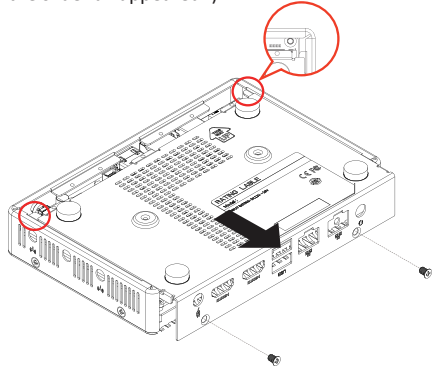

3

Please lift the bottom cover up vertically to avoid damaging the thermal pad.

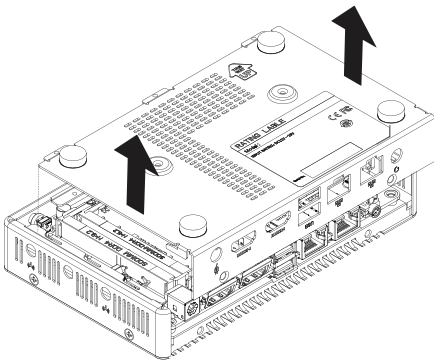

4

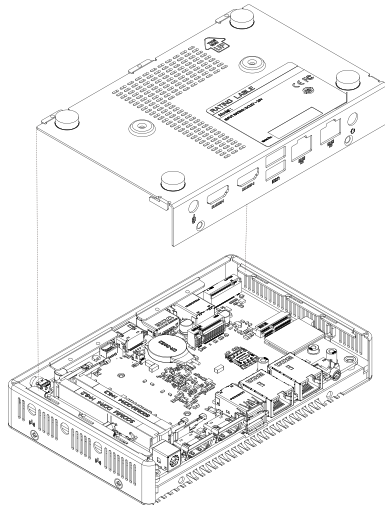

[Bottom PCB Side]

Information	
A	M.2 2230 E-Key connector
B	M.2 3042 B-Key connector
C	M.2 2280 M-Key connector
D	DDR4 SO-DIMM Slot

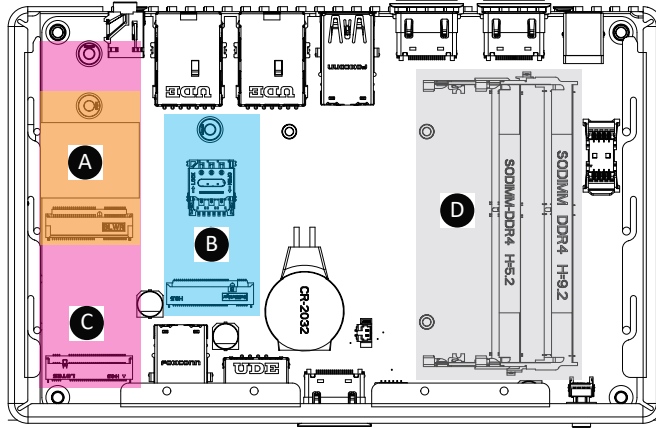

2.3 A) Wireless Module : How to safely install the Module (Wireless Module inclusion may vary based on local distribution)

1

Carefully insert the wireless module into the M.2 slot

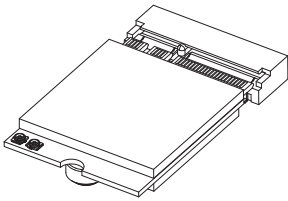

2

Lock the screw in the middle.

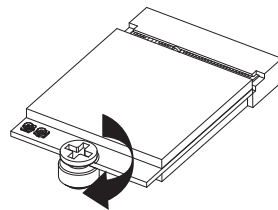

3

Install the antenna on the left side of the connection wireless module down.

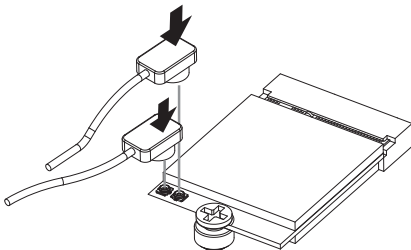

2.4 B) 5G module Installation: How to safely install the module (5G Module inclusion may vary based on local distribution)

1

Remove the screw from the screw hole
(Location : MSO1)

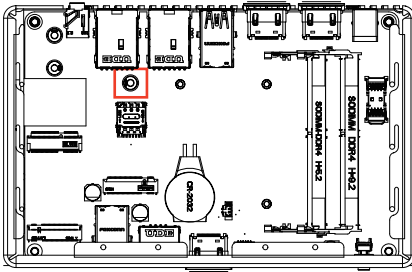

2

Carefully insert the 5G module into the slot, and secure with the screw.

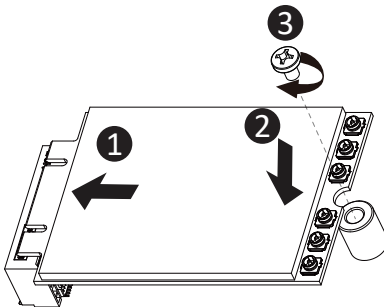

2.5 C) M.2 SSD Installation: How to safely install the M.2 2280 SSD

1

Remove the screw from the screw hole (Location : MS07)

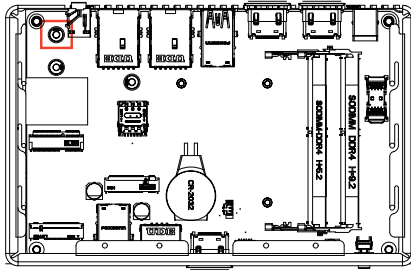

2

Carefully insert the M.2 SSD into the slot, and secure with the screw.

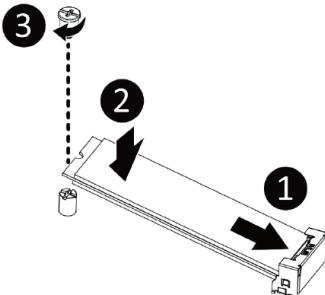

2.6 D) Memory Installation: DDR4 SO-DIMM

1

Carefully insert SO-DIMM memory modules.

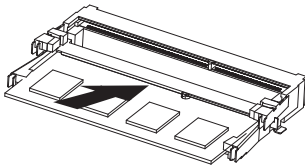
**2**

Push down until the modules click into place.

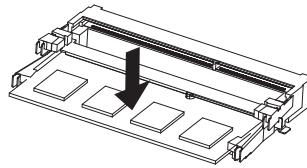
**3**

Carefully insert SO-DIMM memory modules.

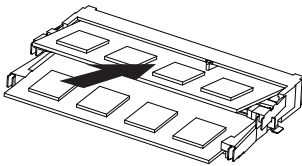
**4**

Push down until the modules click into place.

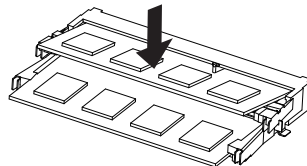

2.7 Antenna Installation (Antenna inclusion may vary based on local distribution)

Either for Wifi antenna or 5G antenna installation.

1

Carefully insert the antennas into the connectors.

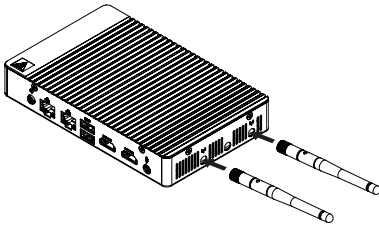

2

Turn the antennas clockwise until they are completely secure on the connectors.

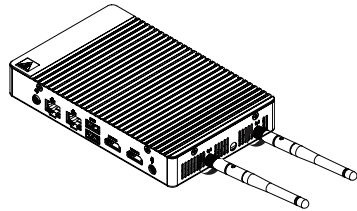

3

Flip up the antenna heads so that they are perpendicular to the machine.

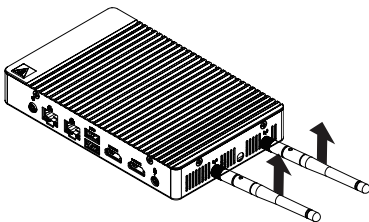

2.8 VESA Bracket Installation

1

Attach the screws provided on the underside of the QBiX-Plus.

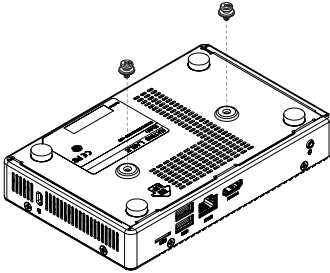
**2**

Attach the VESA mounting plate to the rear of a compatible display using the screws provided.

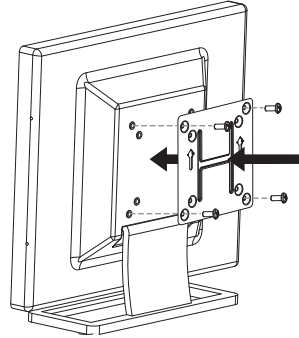
**3**

The QBiX-plus can now be mounted by sliding the device into place.

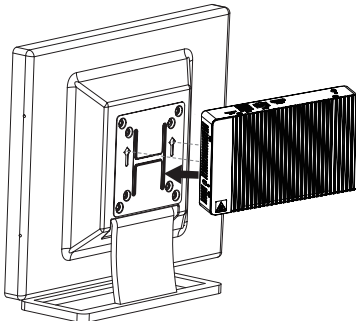

2.9 Safety and Regulatory Information

Risk of explosion if the battery is replaced with an incorrect type. Batteries should be recycled where possible.

Disposal of used Batteries must be in accordance with local environmental regulations.

Failure to use the included Power Adapter may violate regulatory compliance and may expose the user to safety hazards.

HDMI™
HIGH DEFINITION MULTIMEDIA INTERFACE



At the end of its serviceable life, this product should not be treated as household or general waste. It should be handed over to the applicable collection point for the recycling of electrical and electronic equipment, or returned to the supplier for disposal.

Chapter 3

Chapter 3 – Motherboard Pin Define

3.1 Jumpers and Connectors

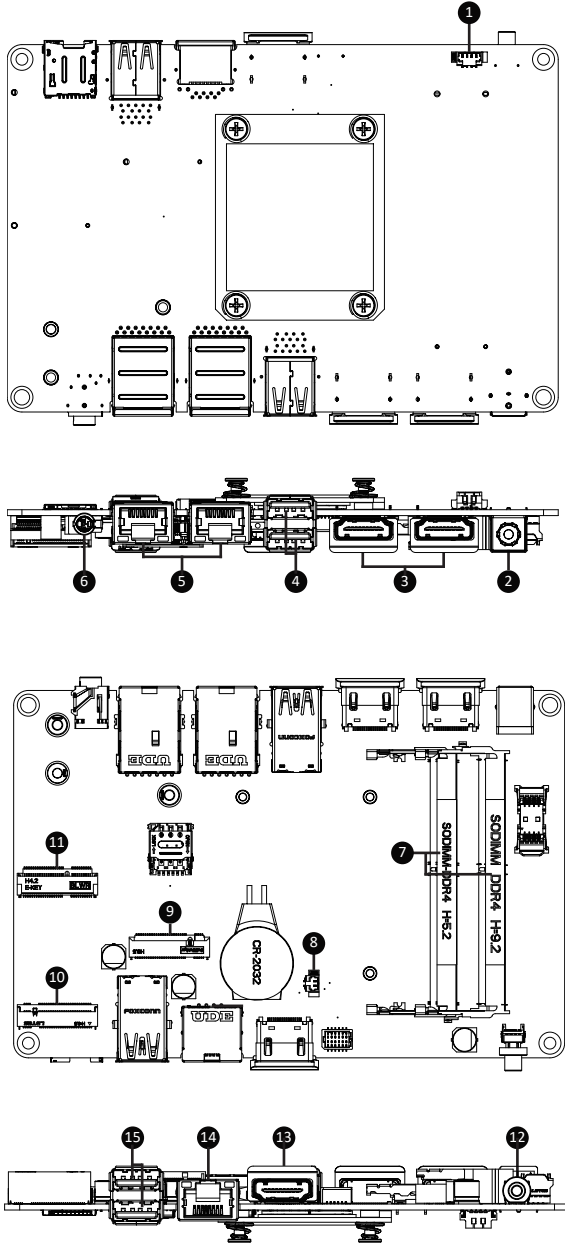

	Code	Description
1	FAN	FAN connector
2	DC_IN	DC Jack connector
3	HDMI1, HDMI2	HDMI connector
4	USB3_1	USB 3.2 Gen 1 Connector
5	LAN1, LAN2	LAN connector
6	HP	Headphone Jack
7	SODIMMA1, SODIMMB1	DDR4 SO-DIMM Slot
8	BATTERY1	Battery cable connector
9	M2B	M.2 Slot, B-Key, NGFF 3042
10	M2M	M.2 Slot, M-Key, NGFF 2280
11	M2E	M.2 Slot, E-key, NGFF 2230
12	PWR_BTN	Power button with LED
13	HDMI3	HDMI connector
14	RJ45_COM	Serial Port (RS-232)(RJ45 type)
15	USB3_2	USB 3.2 Gen 1 Connector

3.2.1 FAN (FAN connector)

1

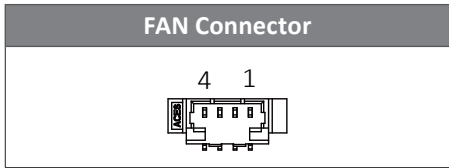
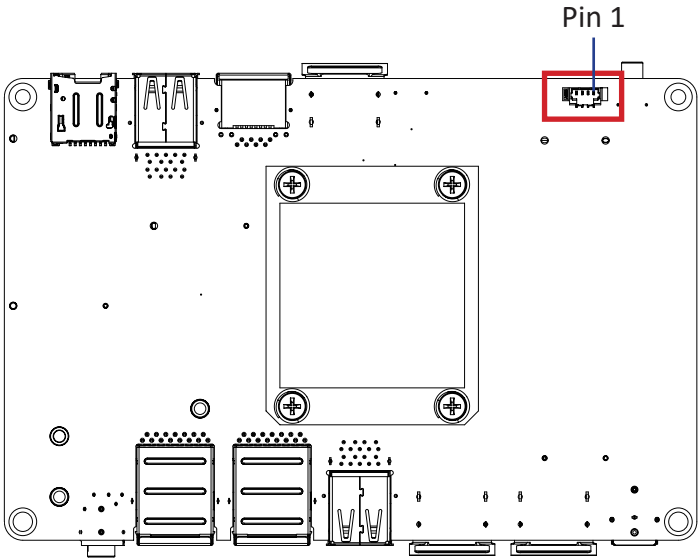

Connector PN	Vendor
85205-0470N	ACE
A1250WV-S-04PC	JOINT-TECH

Pin No.	Definition
1	GND
2	5V
3	NC
4	NC

3.2.2 DC_IN (DC Jack connector)

2

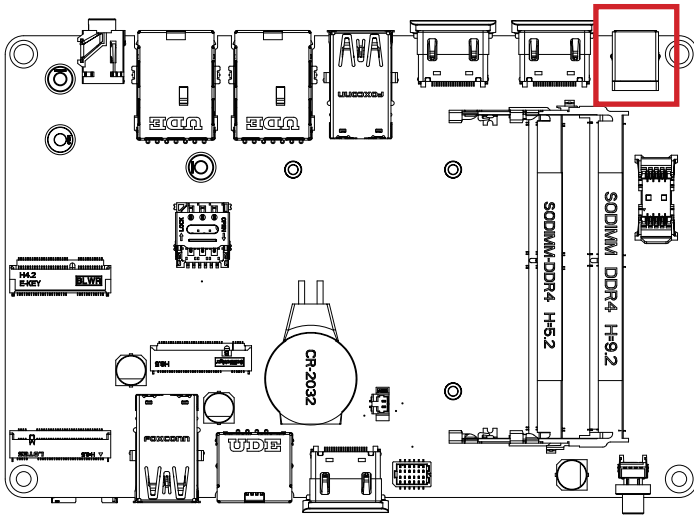

DC_IN Connector

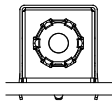

Connector PN

WTJ-020-88JSB

Vendor

KYOYAKU

3.2.3 HDMI1, HDMI2 (HDMI connector)

3

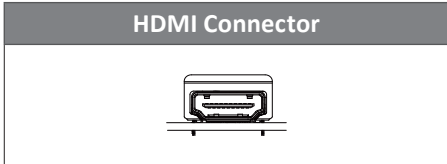
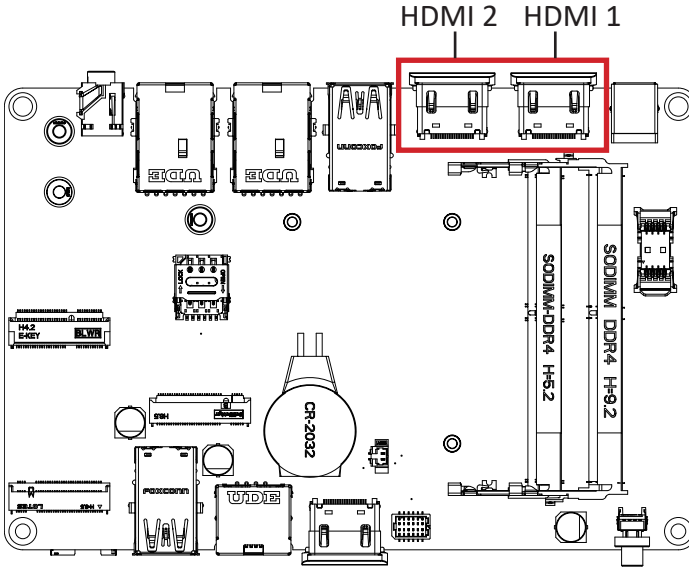

Connector PN	Vendor
1165-2CG04-24P	TCONN

Pin No.	Definition	Pin No.	Definition
1	TX2p	11	GND
2	GND	12	CLKn
3	TX2n	13	NC
4	TX1p	14	NC
5	GND	15	SCL
6	TX1n	16	SDA
7	TX0p	17	GND
8	GND	18	5V
9	TX0n	19	Hot Plug Detect
10	CLKp		

3.2.4 USB3_1 (USB 3.2 Gen 1 connector)

4

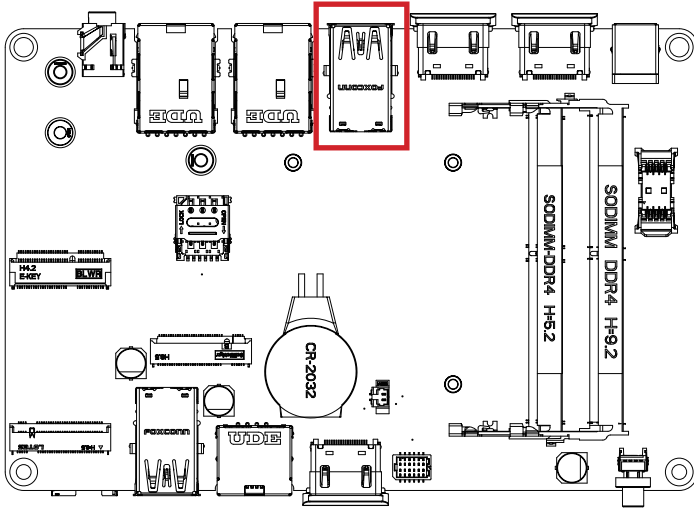

USB 3.2 Gen 1 connector



Connector PN

UEA1141-R23L12-7H

Vendor

FOXCONN

Pin No.	Definition	Pin No.	Definition
1	5V	10	5V
2	D1n	11	D0n
3	D1p	12	D0p
4	GND	13	GND
5	USB3_RX1n	14	USB3_RX2n
6	USB3_RX1p	15	USB3_RX2p
7	GND	16	GND
8	USB3_TX1n	17	USB3_TX2n
9	USB3_TX1p	18	USB3_TX2p

3.2.5 LAN1, LAN2 (LAN connector)

5

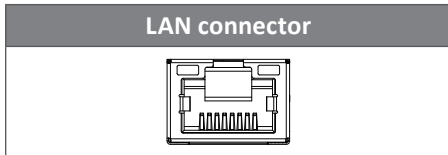
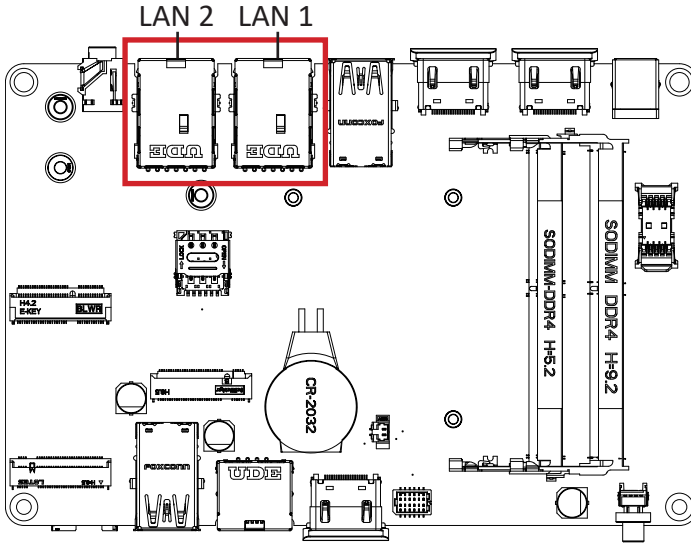

State	Description
Orange On	1Gbps data rate
Green On	100Mbps data rate
Off	10Mbps data rate

Pin No.	Definition	Pin No.	Definition
1	GND	7	P1_MDI2+
2	P1_MDIO+	8	P1_MDI2-
3	P1_MDIO-	9	P1_MDI3+
4	P1_MDI1+	10	P1_MDI3-
5	P1_MDI1-	11	GND
6	GND		

3.2.8 BATTERY1 (Battery cable connector)

8

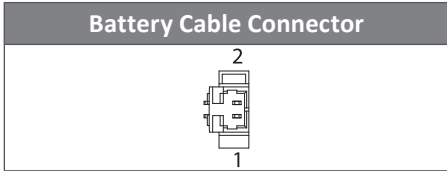
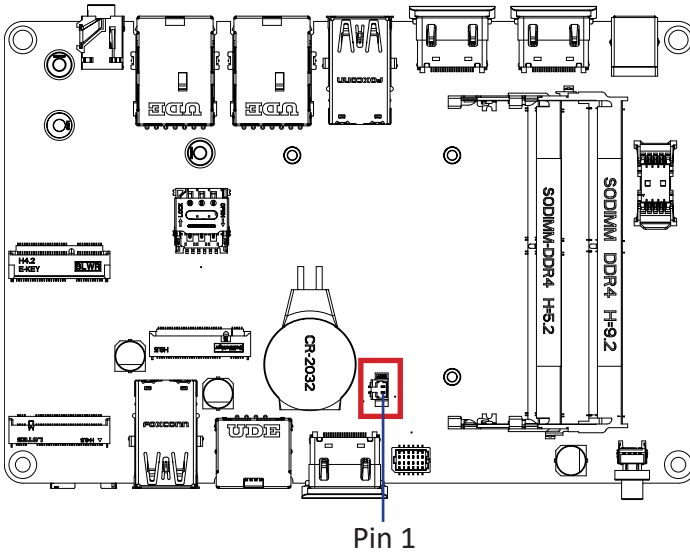

Connector PN	Vendor
85205-0270L	ACES
A1250WV-S-02PC	JOINT-TECH

Pin No.	Definition
1	3.3V
2	GND

3.2.9 M2B (M.2 Slot, B-Key, NGFF 3042)

9

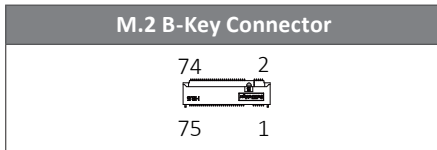
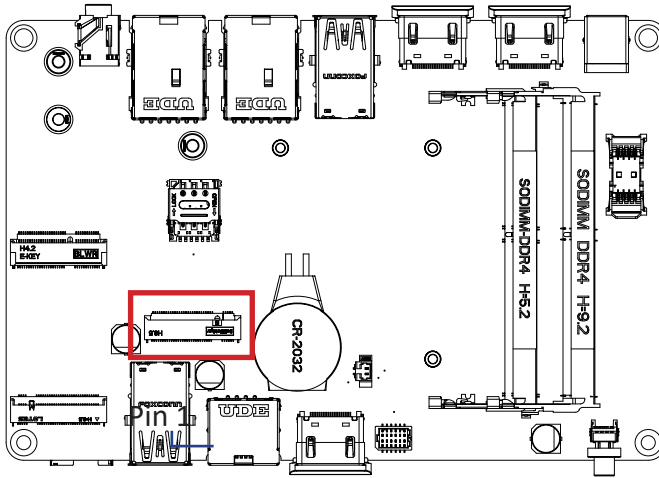

Pin No.	Definition	Pin No.	Definition
1	3.3V	2	3.3V
3	GND	4	3.3V
5	GND	6	WWAN_PWR_OFF
7	USB D+	8	WWAN_Disable
9	USB D-	10	LED
11	GND		

Pin No.	Definition	Pin No.	Definition
21	NC	20	NC
23	NC	22	NC
25	M2B_DRP	24	NC
27	GND	26	WWAN_Disable2
29	USB3 RXn	28	NC
31	USB3_RXp	30	SIM_RST#
33	GND	32	SIM_CLK

Pin No.	Definition	Pin No.	Definition
35	USB3_TXn	34	SIM_DATA
37	USB3_TXp	36	SIM_PWR
39	GND	38	Boot Select
41	PCIE_RXn	40	NC
43	PCIE_RXp	42	NC
45	GND	44	NC
47	PCIE_TXn	46	NC
49	PCIE_TXp	48	NC
51	GND	50	PLT_RST
53	CLK_n	52	CK_REQ
55	CLK_p	54	PCIE_WAKE
57	GND	56	NC
59	NC	58	NC
61	NC	60	NC
63	NC	62	NC
65	NC	64	NC
67	GPP_RESET	66	NC
69	M2B_DET	68	NC
71	GND	70	3.3V
73	GND	72	3.3V
75	M2B_CFG2	74	3.3V

Connector PN	Vendor
80149-8521	BELLWETHER

3.2.10 M2M (M.2 Slot, M-Key, NGFF 2280)

10

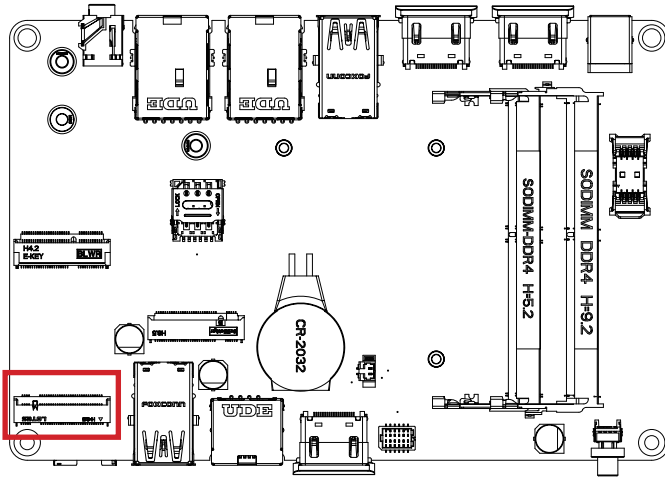

M.2 M Key Connector

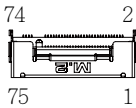

Pin No.	Definition	Pin No.	Definition
1	GND	2	3.3V
3	GND	4	3.3V
5	NC	6	NC
7	NC	8	NC
9	GND	10	M2_LED
11	NC	12	3.3V
13	NC	14	3.3V
15	GND	16	3.3V
17	NC	18	3.3V
19	NC	20	NC
21	GND	22	NC
23	NC	24	NC
25	NC	26	NC
27	GND	28	NC
29	PCIe9_RXn	30	NC
31	PCIe9_RXp	32	NC

Pin No.	Definition	Pin No.	Definition
33	PCIe9_TXn	34	NC
35	PCIe9_TXp	36	NC
37	NC	38	DEVSLP
39	GND	40	SMB Clock
41	SATA_RXp	42	SMB DATA
43	SATA_RXn	44	SMB ALERT
45	GND	46	NC
47	SATA_TXn	48	NC
49	SATA_TXp	50	PERST#
51	GND	52	CLK_REQ
53	CLK_n	54	PCIe_WAKE#
55	CLK_p	56	NC
57	GND	58	NC

Pin No.	Definition	Pin No.	Definition
67	NC	68	SUSCLK
69	PEDET	70	3.3V
71	GND	72	3.3V
73	GND	74	3.3V
75	GND		

Connector PN	Vendor
80159-8521	BELLWETHER

3.2.11 M2E (M.2 Slot, E-key, NGFF 2230)

11

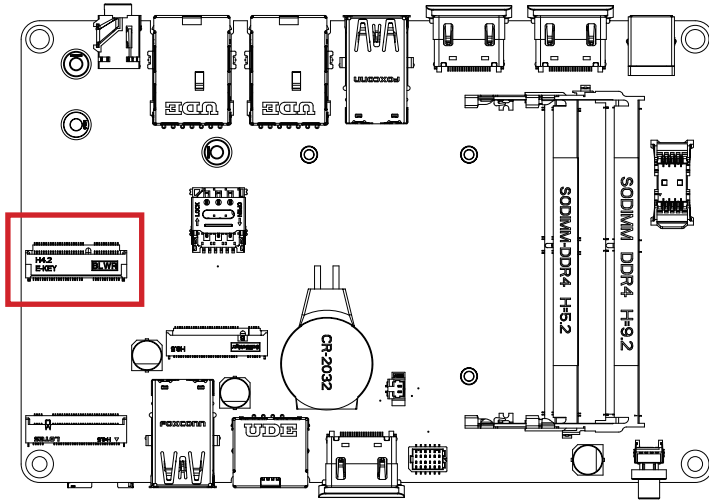

M.2 E Key Connector

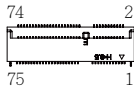

Pin No.	Definition	Pin No.	Definition
1	GND	2	3.3V
3	USBp	4	3.3V
5	USBn	6	NC
7	GND	8	NC
9	NC	10	NC
11	NC	12	NC
13	NC	14	NC
15	NC	16	NC
17	NC	18	GND
19	NC	20	NC
21	NC	22	NC
23	NC		

Pin No.	Definition	Pin No.	Definition
33	GND	32	NC
35	PCIE_TXp	34	NC

37	PCIE_TXn	36	NC
39	GND	38	NC
41	PCIE_RXp	40	NC
43	PCIE_RXn	42	NC
45	GND	44	NC
47	PCIE_CLKp	46	NC
49	PCIE_CLKn	48	NC
51	GND	50	SUSCLK
53	PCIE_CLKREQ	52	PERST#
55	PCIE_WAKE	54	BT_Disable#
57	GND	56	WIFI_Disable#
59	NC	58	NC
61	NC	60	NC
63	GND	62	NC
65	NC	64	NC
67	NC	66	NC
69	GND	68	NC
71	NC	70	NC
73	NC	72	3.3V
75	GND	74	3.3V

Connector PN	Vendor
APCI0076-P001A	LOTES

3.2.12 PWR_BTN (Power button with LED)

12

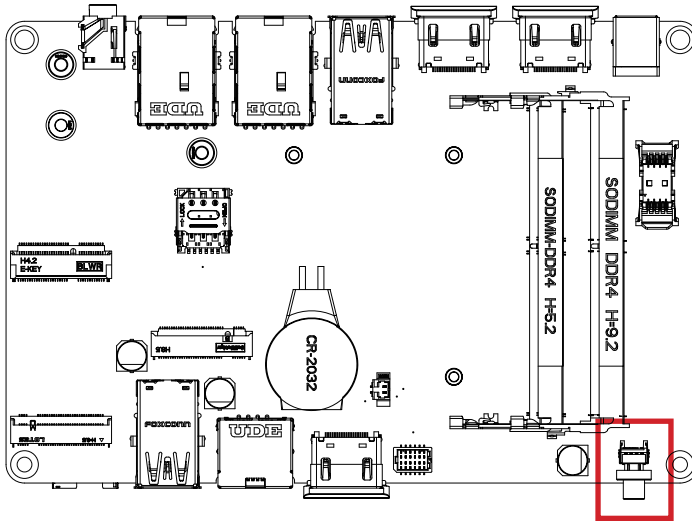

3.2.13 HDMI3 (HDMI connector)

13

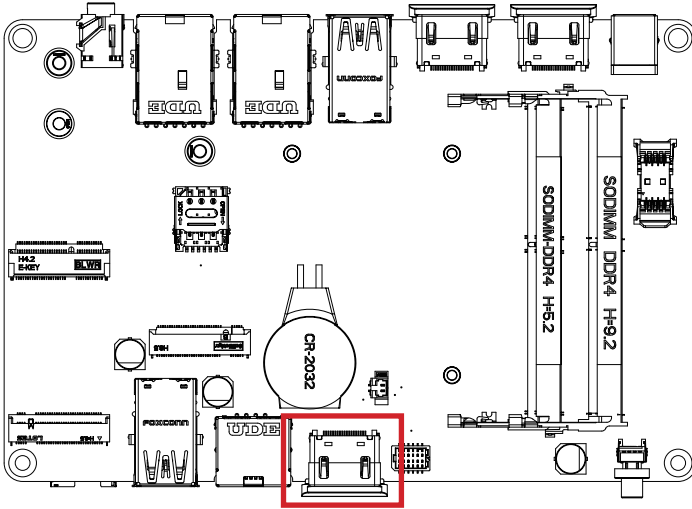

HDMI Connector

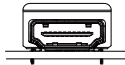

Connector PN

1165-2CG04-24P

Vendor

TCONN

Pin No.	Definition	Pin No.	Definition
1	TX2p	11	GND
2	GND	12	CLKn
3	TX2n	13	NC
4	TX1p	14	NC
5	GND	15	SCL
6	TX1n	16	SDA
7	TX0p	17	GND
8	GND	18	5V
9	TX0n	19	Hot Plug Detect
10	CLKp		

3.2.14 RJ45_COM (Serial Port (RS-232)(RJ45 type))

14

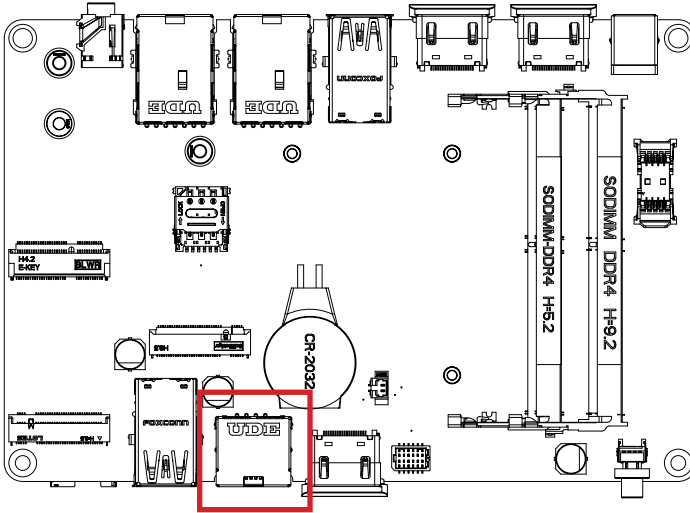

RJ45-COM connector

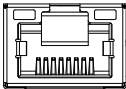

Pin No.	Definition
1	DSR
2	RTS
3	GND
4	TXD
5	RXD
6	DCD
7	CTS
8	DTR

3.2.15 USB3_2 (USB 3.2 Gen 1 connector)

15

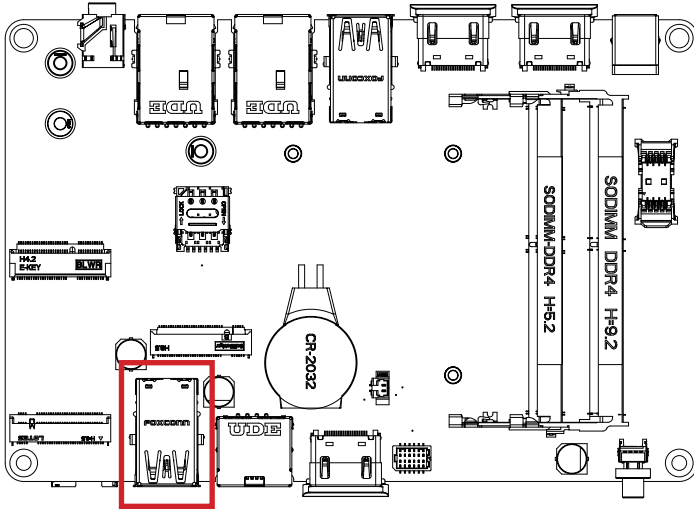

USB 3.2 Gen 1 connector



Connector PN

UEA1141-R23L12-7H

Vendor

FOXCONN

Pin No.	Definition	Pin No.	Definition
1	5V	10	5V
2	D1n	11	D0n
3	D1p	12	D0p
4	GND	13	GND
5	USB3_RX1n	14	USB3_RX2n
6	USB3_RX1p	15	USB3_RX2p
7	GND	16	GND
8	USB3_TX1n	17	USB3_TX2n
9	USB3_TX1p	18	USB3_TX2p

Chapter 4

Chapter 4 – BIOS

4.1 Introduction

BIOS (Basic input/output system) provides hardware detailed information and boot-up options, which include firmware to control, set-up and test all hardware settings. Therefore, BIOS is the communication bridge between OS/application software and hardware.

4.1.1 How to Entering into BIOS menu

Once the system is power on, press the key as soon as possible to access into BIOS Setup program.

4.1.2 Function Keys to setup in BIOS Setup program

Function keys	Description
→←	Select Screen
↑↓	Select Item
Enter	Execute command or enter the submenu
+	Increase the numeric value or make changes
—	Decrease the numeric value or make changes
F1	General Help
F2	Previous Values
F3	Load Optimized Defaults Settings
F4	Save changes & Exit the BIOS Setup program
ESC	Exit the BIOS Setup program

4.2 The Main Menu

The main menu shows the basic system information. Use arrow keys to move among the items.

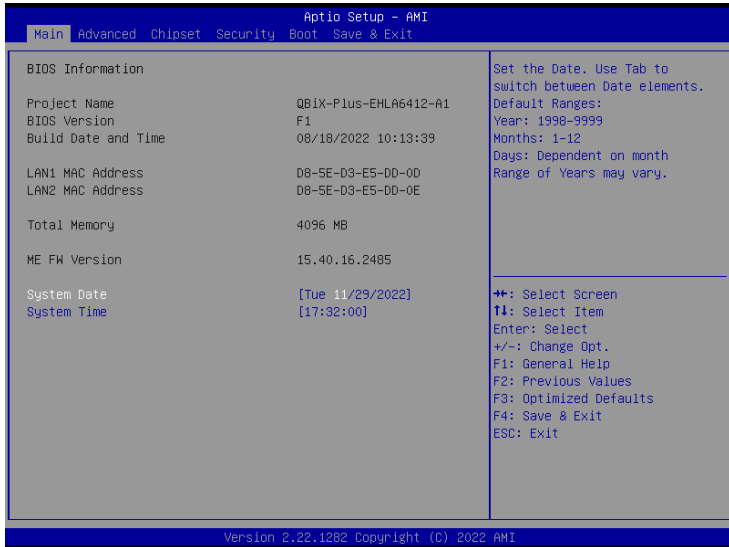

Items	Description
Project Name	Shows Project name information
BIOS Version	Shows the BIOS version of the system
Build Date and Time	Shows the Build Date and Time when the BIOS was created.
LAN1 MAC Address	Shows LAN1 MAC Address information
LAN2 MAC Address	Shows LAN2 MAC Address information
Total Memory	Shows the total memory size of the installed memory
ME FW version	Shows ME firmware version
System Date	Set the Date for the system (Format : Week - Month - Day - Year)
System Time	Set the time for the system (Format : Hour - Minute - Second)

4.3 Advanced

The Advanced menu is to configure the functions of hardware settings through submenu. Use arrow keys to move among the items, and press <Enter> to access into the related submenu.

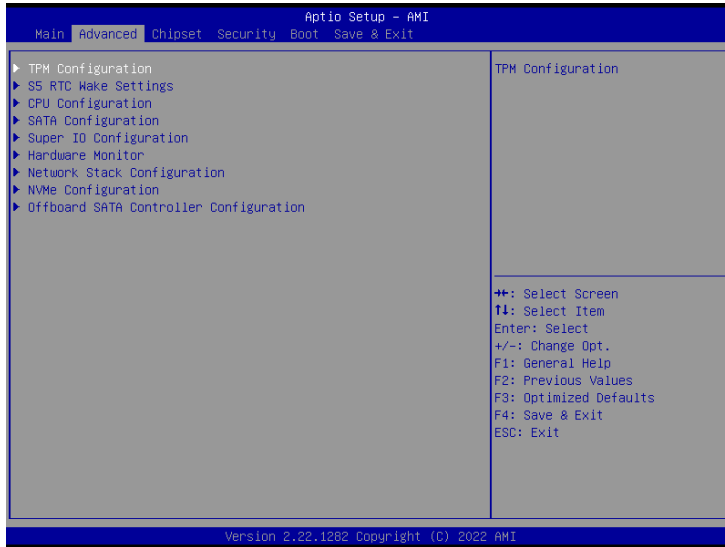

4.3.1 TPM Configuration

Use TPM Configuration submenu to choose TPM interface.



Item	Description
TPM Device Selection	PTT (Default setting)

Trusted Computing : Shows TPM information, and TPM module configuration setting.



Item	Description
Security Device support	Enabled : Enables TPM feature (Default setting) Disabled : Disables TPM feature
Pending operation	None : No execution will be conducted (Default setting) TPM clear : Set to clear data on TPM

4.3.2 S5 RTC Wake Settings



Item	Description
Wake system from S5	Enable or Disable System to wake on a specific time. Disabled : Disables system to wake on a specific time (Default setting) Fixed Time : Enables system to wake on a specific time (Format : hr : min : sec)

4.3.3 CPU Configuration

This submenu shows detailed CPU informations.



Item	Description
Intel Virtualization Technology	Virtualization enhanced by Intel® Virtualization Technology will allow a platform to run multiple operating systems and applications in independent partitions. With virtualization, one computer system can function as multiple virtual systems. Enabled : Enables Intel Virtualization Technology (Default setting) Disabled : Disables Intel Virtualization Technology
Turbo Mode	Enabled : Enables Turbo Mode (Default setting) Disabled : Disables Turbo Mode
CPU C-states	Command CPU to enter into low power consumption mode when CPU is under idle mode. Enabled : Enables C states (Default setting) Disabled : Disables C states
CPU P-states	CPU will adjust frequency depends on it's loading. Enabled : Enables CPU P states function (Default setting) Disabled : Disables CPU P states function

4.3.4 SATA Configuration



Item	Description
SATA Mode Selection	AHCI : Configures the SATA controllers to AHCI mode. (Default setting)
M.2 Port	shows M.2 SATA interface SSD information

4.3.5 Super IO Configuration

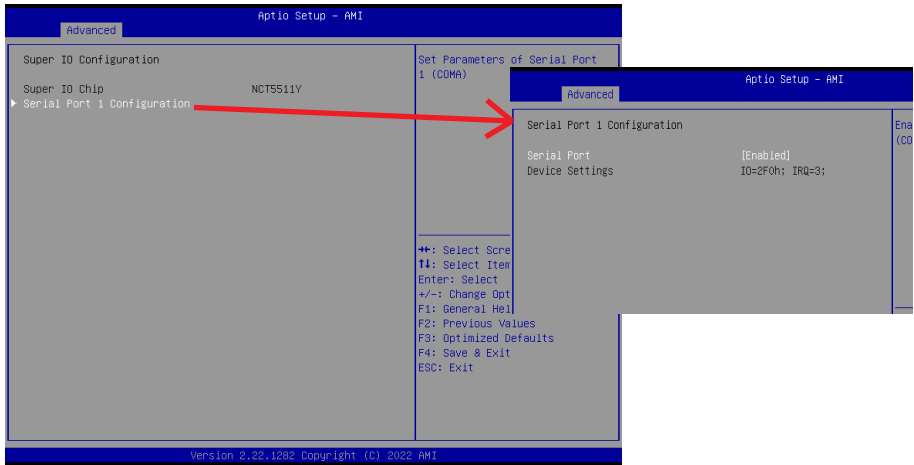

Item	Description
Serial Port 1 Configuration	Press [Enter] to configure advanced items :
	Serial Port : Enabled : Enables allows you to configure the serial port settings Disabled : if Disabled, displays no configuration for the serial port
	Device settings : Display the specified Serial Port base I/O address and IRQ.

4.3.6 Hardware Monitor

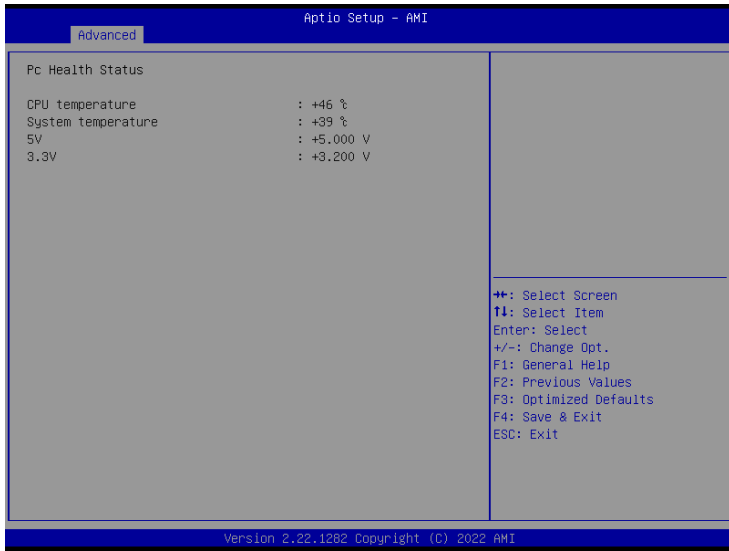

Item	Description
CPU temperature	Shows current CPU temperature
System temperature	Shows current system temperature

4.3.7 Network Stack Configuration

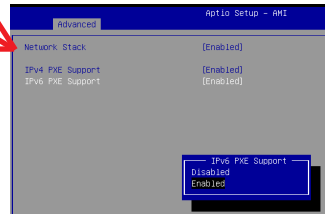
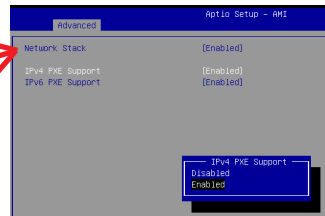
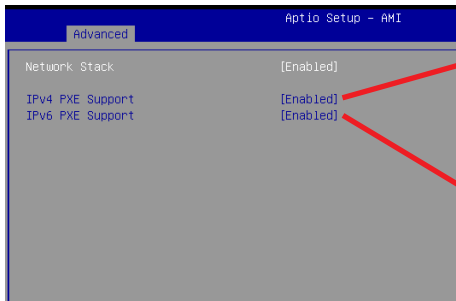
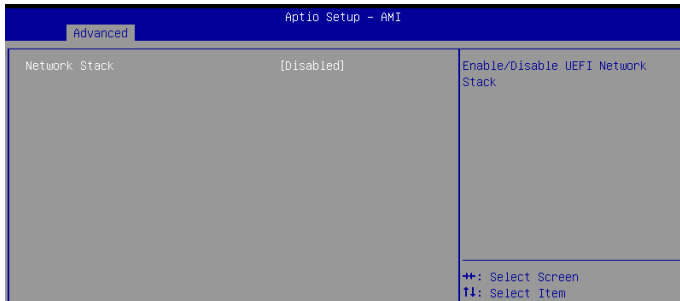

Item	Description
Network Stack	When system is power on, install LAN driver under UEFI mode Disabled : Disables UEFI Network Stack (Default setting) Enabled : Enables UEFI Network Stack
Ipv4 PXE Support	When Network stack is enabled : Disabled : Disables Ipv4 PXE Support Enabled : Enables Ipv4 PXE Support
Ipv6 PXE Support	When Network stack is enabled : Disabled : Disables Ipv6 PXE Support Enabled : Enables Ipv6 PXE Support

4.3.8 NVMe Configuration

NVMe Configuration shows information when your M.2 NVMe PCIe SSD is installed.

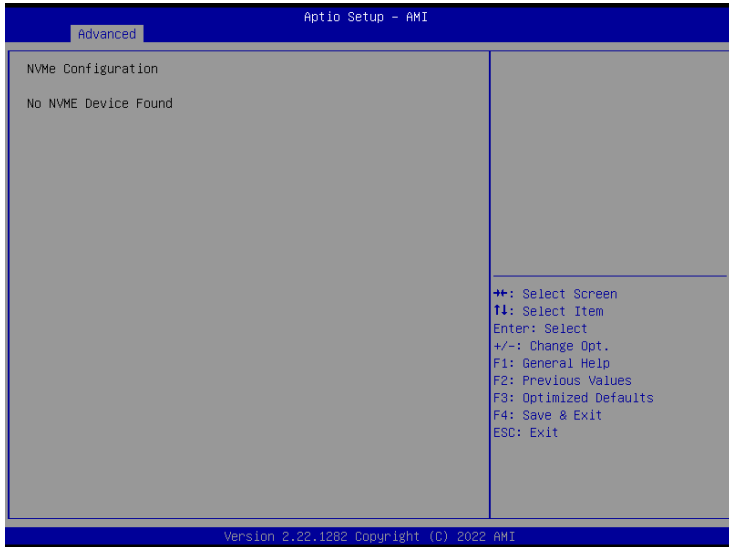

4.3.9 Offboard SATA Controller Configuration

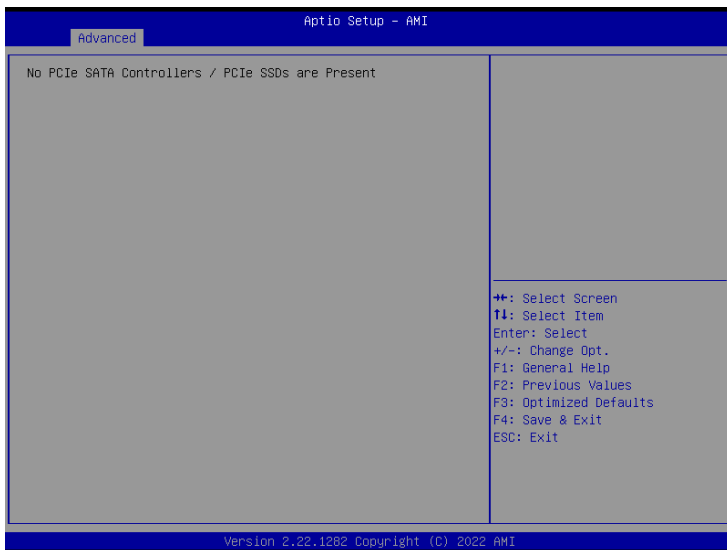

4.4 Chipset

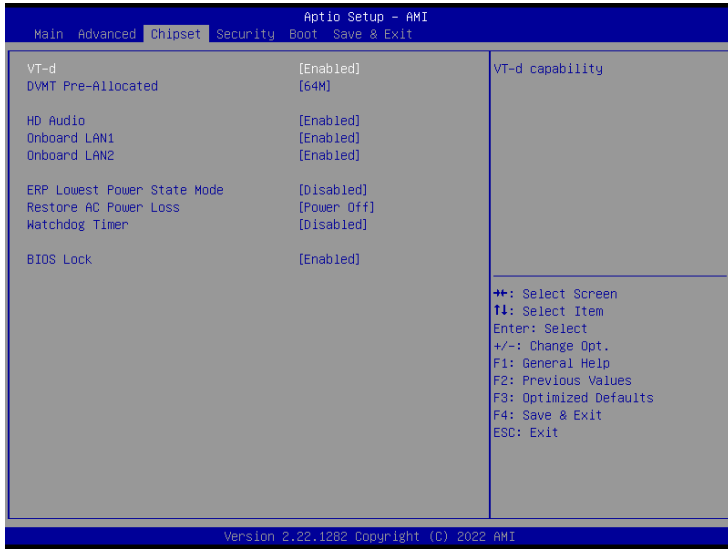

Item	Description
VT-d	Enabled : Enables VT-d function (Default setting) Disabled : Disables VT-d function
DVMT Pre-Allocated	Use DVMT Pre-Allocated to set the amount of system memory which is installed to the integrated graphics processor Option items : 32M , 64M(Default setting) , 128M , 256M
HD Audio	Enable/Disable onboard audio controller Enabled : Enables onboard audio controller (Default setting) Disabled : Disables onboard audio controller
Onboard LAN1 Onboard LAN2	Enable/Disable onboard LAN controller Enabled : Enables onboard LAN controller (Default setting) Disabled : Disables onboard LAN controller
ERP Lowest Power State Mode	Enable/Disable power saving funtion Enabled : Enables ERP Lowest Power State Mode Disabled : Disabled ERP Lowest Power State Mode (Default setting)
Restore AC Power Loss	To set which option the system should returns if a sudden power loss occurred Power off : Do not power on when the power is back (Default setting) Power on : System power on when the power is back Last state : Restore the system to the state before power loss occurs
Watchdog Timer	Enable/Disable Watchdog Timer function Enabled : Enables Watchdog Timer function Disabled : Disabled Watchdog Timer function (Default setting)
BIOS Lock	Enable/Disable BIOS Lock function Enabled : Enables BIOS Lock function (Default setting) Disabled : Disabled BIOS Lock funtion

4.5 Security



Item	Description
Administrator Password	To set up Administrator's password Minimum length : 3 Maximum length : 20
User Password	To set up User's password Minimum length : 3 Maximum length : 20
Secure Boot	Press <Enter> to configure the advanced items



Item	Description
Secure Boot	Secure Boot requires all the applications that are running during the booting process to be pre-signed with valid digital certificates Enabled : Enables Secure Boot function Disabled : Disables Secure Boot function (Default setting)
Secure Boot Mode	Standard : Standard mode Custom : Custom mode (Default setting)
Restore Factory Keys	To restore factory settings Yes : Agree to restore factory settings No : Cancel to restore factory settings
Reset To Setup Mode	Yes : Agree to setup mode No : Cancel to setup mode
Key Management	Enables expert users to modify Secure boot policy variables without full authentication Press <Enter> to configure the advanced items

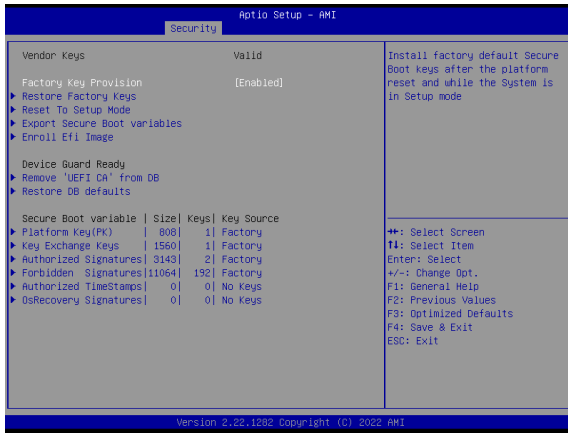

Item	Description
Factory Key Provision	Install factory default Secure Boot keys after the platform reset and while the system is in Setup mode Enabled : Enables Factory Key Provision (Default setting) Disabled : Disables Factory Key Provision
Restore Factory Keys	To restore factory settings Yes : Agree to restore factory settings No : Cancel to restore factory settings
Reset To Setup Mode	Yes : Agree to setup mode No : Cancel to setup mode
Export Secure Boot variables	Copy NVRAM content of Secure Boot variables to files in a root folder on a file system device
Enroll Efi Image	Allow the image to run in Secure Boot mode
Remove 'UEFI CA' from DB	To remove 'UEFI CA' from database Yes : Agree to remove 'UEFI CA' from database No : Cancel to remove 'UEFI CA' from database
Restore DB defaults	Restore DB variables to factory defaults Yes : Agree to restore DB defaults No : Cancel to restore DB defaults

Item	Description
Platform Key (PK)	These items allows you to enroll factory defaults or load Certificates from a file.
Key Exchange Keys	
Authorized Signatures	
Forbidden Signatures	
Authorized TimeStamps	
OsRecovery Signatures	

4.6 Boot

This Boot menu allows you to set/change system boot options



Item	Description
Full Screen LOGO Show	Enable/Disable full screen LOGO show on POST screen Enabled : Enables Full screen LOGO Show on POST screen Disabled : Disables Full screen LOGO Show on POST screen (Default setting)
Boot Option #1	Shows the information of the storage that be installed in the system Choose/set the boot priority

4.7 Save & Exit

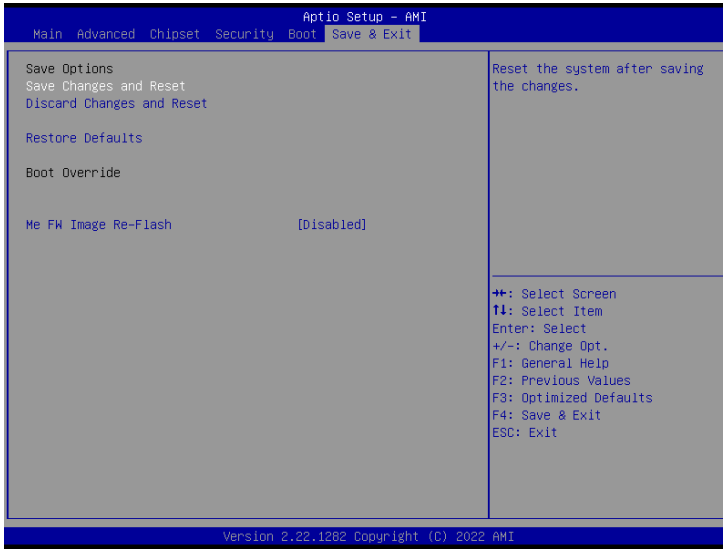

Item	Description
Save Changes and Reset	After configuring all the options that you wish to change, choose this option to save all the changes and reboot the system Yes : Agree to save and reset No : Cancel to save and reset
Discard Changes and Reset	Choose this option to reboot the system without saving any changes Yes : Agree to discard changes and reset No : Cancel to discard changes and reset
Restore Defaults	Restore/Load default values for all the setup options Yes : Agree to load optimized defaults No : Cancel to load optimized defaults
Me FW Image Re-Flash	Enable/Disable Me FW image re-flash function Enabled : Enables Me FW image re-flash function Disabled : Disables Me FW image re-flash function (Default setting)