

UPSIC-1205

12 VDC / 5 A

- ✓ Regulated voltage at backup
- ✓ Supercaps for energy storage
- ✓ Maintenance-free
- ✓ High cycle stability > 500 000
- ✓ Charge time <60 sec at maximum charge current
- ✓ Extended temperature range -20...+70 °C
- ✓ Compact design
- ✓ Active reverse polarity protection
- ✓ Power Fail signal via relay, RS232 connection
- ✓ Intelligent charge sharing



NEW

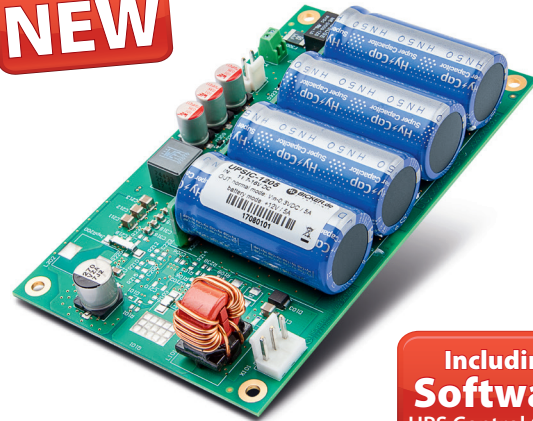

Including Software
UPS Control Center

Technical data	
Input voltage	12 VDC (11.6...16 VDC)
Input current	5.8 A nom.
Output power	60 W
Output voltage battery mode	12 VDC ±2 % regulated
Output voltage normal mode	$V_{in} - 0.3 \text{ V}$ at 100% load
Output current	5 A
Output ripple	≤30 mV
Backup efficiency	97 % ($V_{\text{Supercaps}} = 9.5 \text{ V}, I_{\text{out}} = 2.5 \text{ A}$)
Charge current	Depending on load up to 6.2 A CC (V_{Supercap})
Charging method	CC / CV
Storage type	Supercaps 4x 100 F
Charging time	<60 sec at maximum charge current @ 4x 100 F
Backup time	See diagram
Protection	Overcurrent protection – Non LATCH Active reverse polarity protection
Temperature	Operating: -20...+70 °C / Storage: -20...+70 °C
Humidity	Operating: 10...85 % RH, non-condensing / Storage: 10...90 % RH, non-condensing
Dimensions (WxDxH)	135 x 79.5 x 28.5 mm incl. supercaps @ 4x 100 F
Weight (net)	0.17 kg @ 4x 100 F

Optional Accessories

▷▷▷ For detailed information please visit our website www.bicker.de and refer to the article number.

PSZ-1036 | Input cable

3-pole, length 500mm, AWG 18, ends open

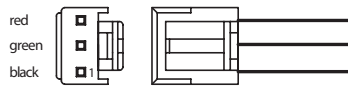

PSZ-1037 | Output cable

2-pole, length 500mm, AWG 18, ends open



PSZ-1063 | μExtension module

μExtension module for DC2412-UPS(LD) – UPSIC-2403 – UPSIC-1205

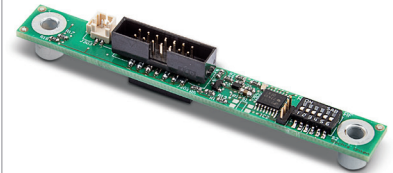

PSZ-1046/PSZ-1048 | Interface cable

Interface cable for UPSIC and DC2412, PSZ-1046: IDC 2.0 to SUB-D 9 pin female, PSZ-1048: IDDC 2.0 to IDC 2.54

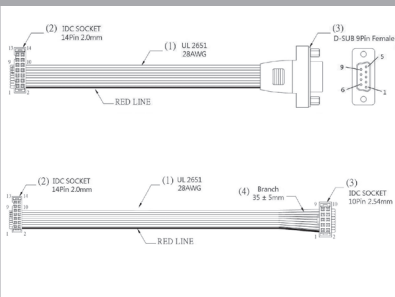

PSZ-1043/PSZ-1044 | Interface cable

For UPSIC and DC2412-UPS (-LD), PSZ-1043: TP connector wire open end, PSZ-1044: TP connector wire 2.54 mm

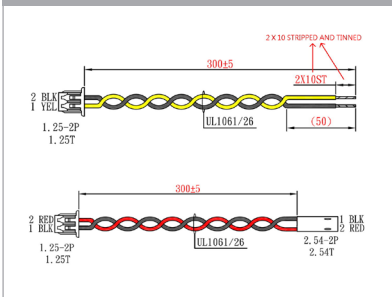

PSZ-1009 | Male adapter

DCplug: 2.5 x 5.5 mm, AWG 26-12



Backup time

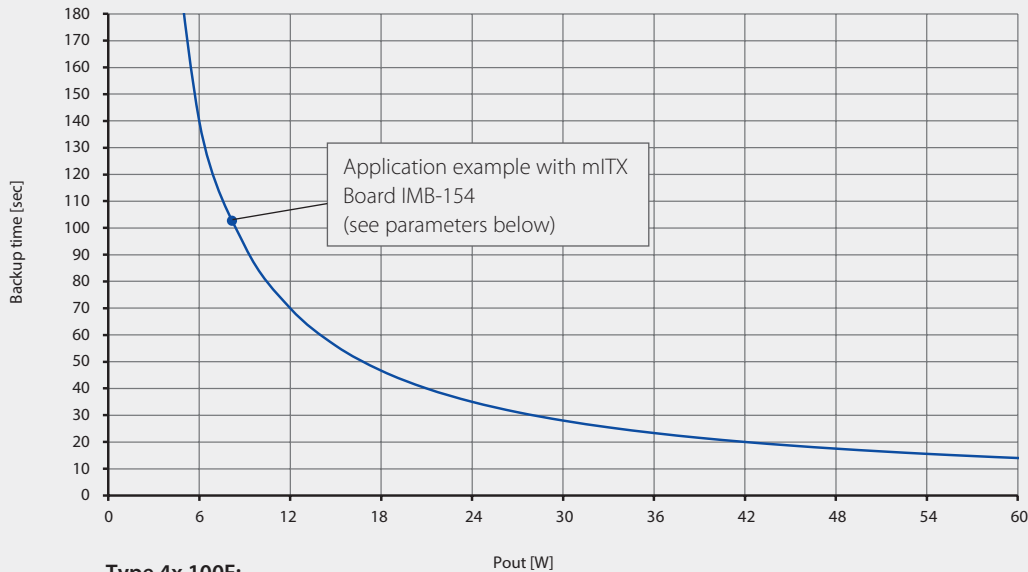

Type 4x 100F:
Standby@NoLoad >30 min
— @nom. Cap. & 25 °C

Parameters of the test system for the backup curve

Board	IMB-154 L0.36 SN: 59M0X2003883 CPU: Braswell N3150; 4x 1.60GHz	ROM	1x mSATA 32GB Type: CIE MSM300M JB032GS SN: CIE164905767
RAM	2 x 4 GB / DDR3 SO-DIMM 1600MHz FB Type: CIR-S3SUSKA 1604G SN: CIR 154630106 CIR 154630106	OS	Microsoft Windows 10 Enterprise Evaluation Version 1511 Build 10586.589 (2016/09/16)
		Test Software	BurnInTest V7.1 Pro
		Test results	100% load: 1 min. 43 sec. = 103 sec

Software UPS Control Center

UPS Control Center

The UPS software is available for free download directly on the product page at www.bicker.de.

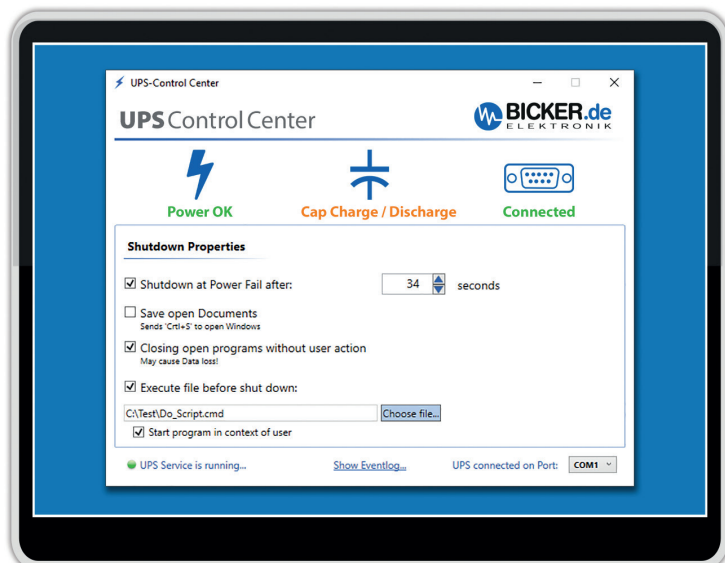

Drawing UPSIC-1205

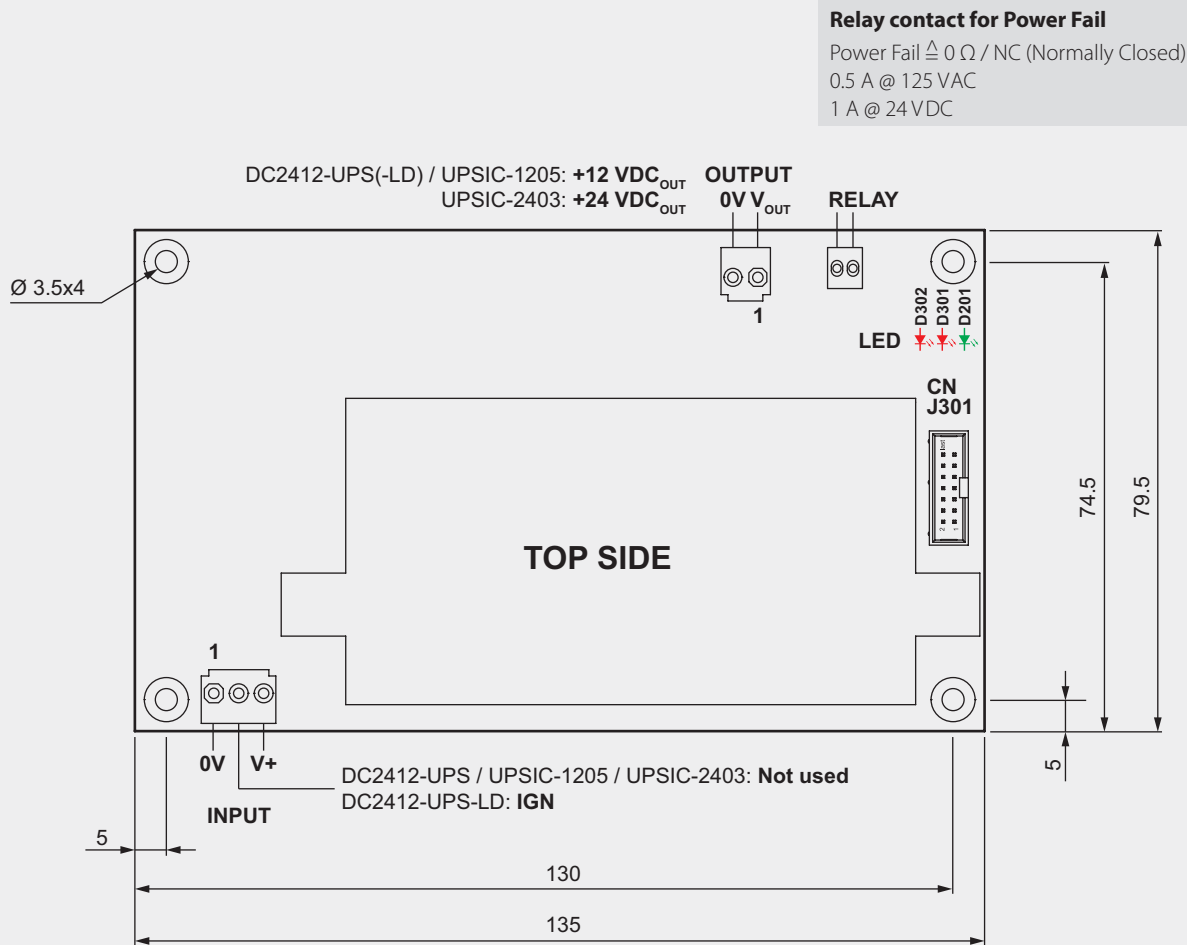

CN J301 – Pin assignment

RS232

01	DCD
02	DSR signal (Low = Cap >90%; High = Cap <90%)
03	NC
04	RTS signal (Supply voltage, max. 12V)
05	NC
06	CTS signal (Low = Power Fail; High = Power OK)
07	NC
08	\overline{OD} (Output Disable)
09	GND

I²C

10	SMB alert
11	GND
12	XSDA I ² C
13	V _{Out}
14	XSCL I ² C

Connectors

INPUT	VHR-3N (1: 0V, 2: n.c., 3: V+)
OUTPUT	VHR-2N (1: V+, 2: 0V)
CN J301	WR-BHD62501021621 (pitch 2.0mm)
RELAY	WR-691210910002

LED

D302	RED	Caps charging state < 90%
D301	RED	Power fail, backup mode
D201	GREEN	Normal mode

Tolerance ± 0.5 mm

Interface schematic J301

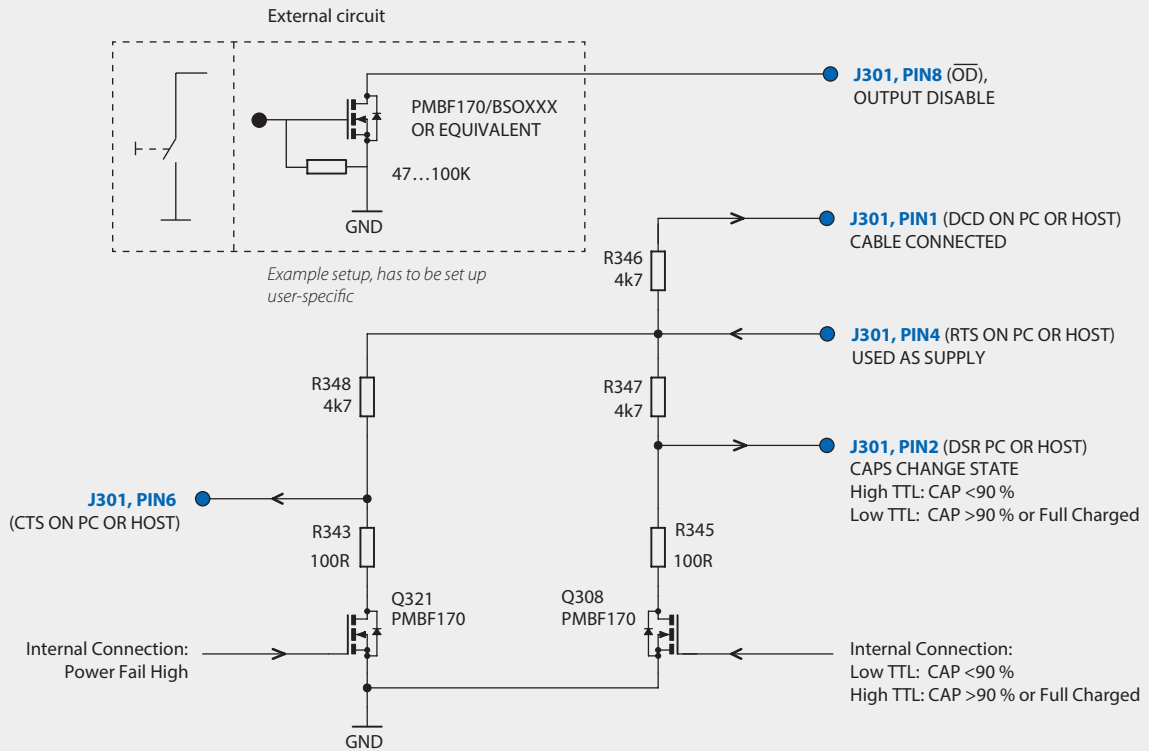

Recommended power supplies from Bicker Elektronik >>> Additional recommendations on www.bicker.de

BET-0912-T	BET-1012M	BEN-10012
90 Watt	100 Watt	100 Watt



Specification is subject to change without notice. Errors excepted. Status as at: 15.10.2021