

USER'S MANUAL

VCO-6000-RPL

Machine Vision Computer



Table of Contents

Prefaces	04
Revision	04
Disclaimer	04
Copyright Notice	04
Trademarks Acknowledgment	04
Environmental Protection Announcement	04
Safety Precautions	05
Technical Support and Assistance	06
Conventions Used in this Manual	06
Package Contents	07
Ordering Information	08
Optional Accessory	09
Chapter 1 Product Introductions	10
1.1 Overview	11
1.1.1 Key Feature	14
1.2 Hardware Specification	15
1.3 System I/O	18
1.3.1 VCO-6000-RPL-3E	18
VCO-6000-RPL-3E Expansion	19
1.3.2 VCO-6000-RPL-4E	20
VCO-6000-RPL-4E Expansion	21
1.4 Mechanical Dimension	22
1.4.1 VCO-6000-RPL-3E	22
1.4.2 VCO-6000-RPL-4E	23
Chapter 2 Mechanical Specifications.....	24
2.1 Switch and connector Locations	25
2.1.1 Top View	25
2.1.2 Bottom View	26
2.2 Connector / Switch Definition	27
2.3 I/O Interface Descriptions	28
Chapter 3 System Setup	70
3.1 Set torque force to 3.5 kgf cm to execute all the screwing and Unscrewing	71
3.2 Removing heat sink cover	71
3.3 Install CPU	74
3.4 Install the first DRAM externally	76
3.5 Install the second DRAM externally	78
3.6 Install CPU & SODIMM heat block	79
3.7 Install HDD/SSD on the internal SATA bay	84
3.8 Install HDD on removable SATA HDD bay	86
3.9 Install M.2 SSD card	89
3.10 Install WiFi Module	90
3.11 Install Mini PCIe card / 4G LTE	93
3.12 Install Antenna	94
3.13 Install graphic Card (For Superior Machine Vision System)	96

3.14	Install wall mount kit	103
3.15	AC Adapter with 4P terminal block	104
3.16	AC Adapter with 5P terminal block	105
Chapter 4	BIOS Setup	106
4.1	BIOS Introduction	107
4.2	Main Setup	108
4.3	Advanced Setup	109
4.3.1	Connectivity Configuration	110
4.3.2	CPU Configuration	111
4.3.3	PCH-FW Configuration	113
4.3.4	SATA and RST Configuration	114
4.3.5	RST (UEFI RAID) Configuration	115
4.3.6	Trusted Computing	117
4.3.7	ACPI Settings	118
4.3.8	Super IO Configuration	119
4.3.9	Hardware Monitor	126
4.3.10	Power IGN Mode	128
4.3.11	Wake system from S5	129
4.3.12	Serial Port Console Redirection	130
4.3.13	USB Configuration	131
4.3.14	Network Stack Configuration	132
4.3.15	CSM Configuration	133
4.3.16	NVMe Configuration	134
4.4	Chipset	135
4.4.1	System Agent (SA) Configuration	135
4.4.2	PCH-IO Configuration	141
4.5	Security	145
4.6	Boot	148
4.7	Save & Exit	149
4.8	MEBx	150
Appendix WDT & GPIO	151
	WDT Sample Code	152
	GPIO Sample Code	153

Prefaces

Revision

Revision	Description	Date
1.0	Manual Released	2023/10/12

Disclaimer

All specifications and information in this User's Manual are believed to be accurate and up to date. C&T Solution Inc. does not guarantee that the contents herein are complete, true, accurate or non-misleading. The information in this document is subject to change without notice and does not represent a commitment on the part of C&T Solution Inc.

C&T Solution Inc. disclaims all warranties, express or implied, including, without limitation, those of merchantability, fitness for a particular purpose with respect to contents of this User's Manual. Users must take full responsibility for the application of the product.

Copyright Notice

All rights reserved. No part of this manual may be reproduced or transmitted in any form or by any means, electronic or mechanical, including photocopying, recording, or information storage and retrieval systems, without the prior written permission of C&T Solution Inc. Copyright © C&T Solution Inc.

Trademarks Acknowledgment

Intel®, Celeron® and Pentium® are trademarks of Intel Corporation.

Windows® is registered trademark of Microsoft Corporation.

AMI is trademark of American Megatrend Inc.

IBM, XT, AT, PS/2 and Personal System/2 are trademarks of International Business Machines Corporation

All other products and trademarks mentioned in this manual are trademarks of their respective owners.

Environmental Protection Announcement

Do not dispose this electronic device into the trash while discarding. Please recycle to minimize pollution and ensure environment protection.

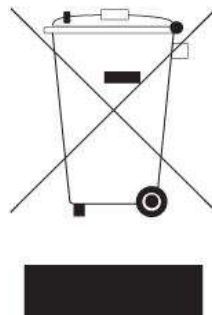

Safety Precautions

Before installing and using the equipment, please read the following precautions:

- Put this equipment on a reliable surface during installation. Dropping it or letting it fall could cause damage.
- The power outlet shall be installed near the equipment and shall be easily accessible.
- Turn off the system power and disconnect the power cord from its source before making any installation. Be sure both the system and the external devices are turned OFF. Sudden surge of power could ruin sensitive components. Make sure the equipment is properly grounded.
- When the power is connected, never open the equipment. The equipment should be opened only by qualified service personnel.
- Make sure the voltage of the power source is correct before connecting the equipment to the power outlet.
- Disconnect this equipment from the power before cleaning. Use a damp cloth. Do not use liquid or spray detergents for cleaning.
- Avoid the dusty, humidity and temperature extremes.
- Do not place heavy objects on the equipment.
- If the equipment is not used for long time, disconnect it from the power to avoid being damaged by transient over-voltage.
- The storage temperature shall be above -30°C and below 85°C .
- The computer is provided with a battery-powered real-time clock circuit. There is a danger of explosion if incorrectly replaced. Replace only with the same or equivalent type recommended by the manufacturer.
- If one of the following situation arises, get the equipment checked by service personnel:
 - The power cord or plug is damaged.
 - Liquid has penetrated into the equipment.
 - The equipment has been exposed to moisture.
 - The equipment does not work well or it cannot work according the user's manual.
 - The equipment has been dropped and damaged.
 - The equipment has obvious signs of breakage.

Technical Support and Assistance

1. Visit the C&T Solution Inc website at <https://www.candtsolution.com> where you can find the latest information about the product.
2. Contact your distributor, our technical support team or sales representative for technical support if you need additional assistance. Please have following information ready before you call:
 - Model name and serial number
 - Description of your peripheral attachments
 - Description of your software (operating system, version, application software, etc.)
 - A complete description of the problem
 - The exact wording of any error messages

Conventions Used in this Manual

**WARNING**

This indication alerts operators to an operation that, if not strictly observed, may result in severe injury.

**CAUTION**

This indication alerts operators to an operation that, if not strictly observed, may result in safety hazards to personnel or damage to equipment.

**NOTE**

This indication provides additional information to complete a task easily.

Package Contents

Before installation, please ensure all the items listed in the following table are included in the package.

Item	Description	Q'ty
1	<u>Choosing one :</u> <ul style="list-style-type: none">• VCO-6000-RPL-3E Series• VCO-6000-RPL-4E Series	1
2	Wall Mount Kit	1
3	Accessory Kit	1
4	DVI to VGA Adapter	1

Ordering Information

VCO-6000-RPL-3E Series

Model No.	Product Description
VCO-6000-RPL-3E	Machine Vision Computer w/ LGA 1700 for Intel 12/13 th Gen CPU & R680E PCH, 3x PCIe
VCO-6000-RPL-3E-4B7M	Machine Vision Computer w/ LGA 1700 for Intel 12/13 th Gen CPU & R680E PCH, 3x PCIe, 6x HDD
VCO-6000-RPL-3E-2B15M	Machine Vision Computer w/ LGA 1700 for Intel 12/13 th Gen CPU & R680E PCH, 3x PCIe, 4x HDD
VCO-6000-RPL-3E-2N15M	Machine Vision Computer w/ LGA 1700 for Intel 12/13 th Gen CPU & R680E PCH, 3x PCIe, 2x 15mm NVMe
VCO-6000-RPL-3E-2PWR	Machine Vision Computer w/ LGA 1700 for Intel 12/13 th Gen CPU & R680E PCH, 3x PCIe, 2x Power input
VCO-6000-RPL-3E-4B7M-2PWR	Machine Vision Computer w/ LGA 1700 for Intel 12/13 th Gen CPU & R680E PCH, 3x PCIe, 6x HDD, 2x Power input
VCO-6000-RPL-3E-2B15M-2PWR	Machine Vision Computer w/ LGA 1700 for Intel 12/13 th Gen CPU & R680E PCH, 3x PCIe, 4x HDD, 2x Power input
VCO-6000-RPL-3E-2N15M-2PWR	Machine Vision Computer w/ LGA 1700 for Intel 12/13 th Gen CPU & R680E PCH, 3x PCIe, 2x 15mm NVMe, 2x Power input

VCO-6000-RPL-4E Series

Model No.	Product Description
VCO-6000-RPL-4E	Machine Vision Computer w/ LGA 1700 for Intel 12/13 th Gen CPU & R680E PCH, 3x PCIe
VCO-6000-RPL-4E-4B7M	Machine Vision Computer w/ LGA 1700 for Intel 12/13 th Gen CPU & R680E PCH, 3x PCIe, 6x HDD
VCO-6000-RPL-4E-2B15M	Machine Vision Computer w/ LGA 1700 for Intel 12/13 th Gen CPU & R680E PCH, 3x PCIe, 4x HDD
VCO-6000-RPL-4E-2N15M	Machine Vision Computer w/ LGA 1700 for Intel 12/13 th Gen CPU & R680E PCH, 3x PCIe, 2x 15mm NVMe
VCO-6000-RPL-4E-2PWR	Machine Vision Computer w/ LGA 1700 for Intel 12/13 th Gen CPU & R680E PCH, 3x PCIe, 2x Power input
VCO-6000-RPL-4E-4B7M-2PWR	Machine Vision Computer w/ LGA 1700 for Intel 12/13 th Gen CPU & R680E PCH, 3x PCIe, 6x HDD, 2x Power input
VCO-6000-RPL-4E-2B15M-2PWR	Machine Vision Computer w/ LGA 1700 for Intel 12/13 th Gen CPU & R680E PCH, 3x PCIe, 4x HDD, 2x Power input
VCO-6000-RPL-4E-2N15M-2PWR	Machine Vision Computer w/ LGA 1700 for Intel 12/13 th Gen CPU & R680E PCH, 3x PCIe, 2x 15mm NVMe, 2x Power input

Optional Accessories

Model No.	Product Description
1-E09A22102	Adapter AC/DC 24V 9.2A 220W with 3pin Terminal Block Plug 5.0mm Pitch
1-E09A22801	Adapter AC/DC 24V/11.67A 280W with 3pin Terminal Block Plug 5.0mm Pitch
1-E09A36001	Adapter AC/DC 24V/15A 360W with 3pin Terminal Block Plug 5.0mm Pitch
SFICBL022	Power Cord, 3-pin US Type, 180cm
1-TPCD00002	Power Cord, European Type, 180cm
1-TPCD00001	Power Cord, 3-pin UK Type, 180cm
3-RC6300EXFAN	External Double FAN KIT

Chapter 1

Product Introductions

1.1 Overview

The VCO-6000-RPL Series Machine Vision Systems provide powerful computing and excellent graphic performance, which are suitable for graphic-intensive and computing-oriented applications including image and vision measurement, machine automation. Delivering high quality, durability and compact construction, the systems leverage a reliable fanless and cable-free configuration, optimal thermal dissipation, and easy installation for flexible and user-friendly system development and application implementation in harsh environments.

Machine Vision Computer

**VCO-6000-RPL-3E
Series**



**VCO-6000-RPL-4E
Series**



VCO-6000-RPL-3E Series

Model No.	Front Panel
<ul style="list-style-type: none"> • VCO-6000-RPL-3E 1x PCIe x16 (Gen4), 2x PCIe x1 (Gen3) 	
<ul style="list-style-type: none"> • VCO-6000-RPL-3E-2PWR 1x PCIe x16 (Gen4), 2x PCIe x1 (Gen3), 2x Power input 	
<ul style="list-style-type: none"> • VCO-6000-RPL-3E-4B7M 1x PCIe x16 (Gen4), 2x PCIe x1 (Gen3), 6x HDD 	
<ul style="list-style-type: none"> • VCO-6000-RPL-3E-4B7M-2PWR 1x PCIe x16 (Gen4), 2x PCIe x1 (Gen3), 6x HDD, 2x Power input 	
<ul style="list-style-type: none"> • VCO-6000-RPL-3E-2B15M 1x PCIe x16 (Gen4), 2x PCIe x1 (Gen3), 4x HDD 	
<ul style="list-style-type: none"> • VCO-6000-RPL-3E-2B15M-2PWR 1x PCIe x16 (Gen4), 2x PCIe x1 (Gen3), 4x HDD, 2x Power input 	
<ul style="list-style-type: none"> • VCO-6000-RPL-3E-2N15M 1x PCIe x16 (Gen4), 2x PCIe x1 (Gen3), 2x 15mm NVMe 	
<ul style="list-style-type: none"> • VCO-6000-RPL-3E-2N15M-2PWR 1x PCIe x16 (Gen4), 2x PCIe x1 (Gen3), 2x 15mm NVMe, 2x Power input 	

VCO-6000-RPL-4E Series

Model No.	Front Panel
<ul style="list-style-type: none"> • VCO-6000-RPL-4E 2x PCIe x16 Slot (x8 Lane, Gen 4), 1x PCIe x4 (x1 Lane, Gen 3) 	
<ul style="list-style-type: none"> • VCO-6000-RPL-4E-2PWR 2x PCIe x16 Slot (x8 Lane, Gen 4), 1x PCIe x4 (x1 Lane, Gen 3), 2x Power input 	
<ul style="list-style-type: none"> • VCO-6000-RPL-4E-4B7M 2x PCIe x16 Slot (x8 Lane, Gen 4), 1x PCIe x4 (x1 Lane, Gen 3), 6x HDD 	
<ul style="list-style-type: none"> • VCO-6000-RPL-4E-4B7M-2PWR 2x PCIe x16 Slot (x8 Lane, Gen 4), 1x PCIe x4 (x1 Lane, Gen 3), 6x HDD, 2x Power input 	
<ul style="list-style-type: none"> • VCO-6000-RPL-4E-2B15M 2x PCIe x16 Slot (x8 Lane, Gen 4), 1x PCIe x4 (x1 Lane, Gen 3), 4x HDD 	
<ul style="list-style-type: none"> • VCO-6000-RPL-4E-2B15M-2PWR 2x PCIe x16 Slot (x8 Lane, Gen 4), 1x PCIe x4 (x1 Lane, Gen 3), 4x HDD, 2x Power input 	
<ul style="list-style-type: none"> • VCO-6000-RPL-4E-2N15M 2x PCIe x16 Slot (x8 Lane, Gen 4), 1x PCIe x4 (x1 Lane, Gen 3), 2x 15mm NVMe 	
<ul style="list-style-type: none"> • VCO-6000-RPL-4E-2N15M-2PWR 2x PCIe x16 Slot (x8 Lane, Gen 4), 1x PCIe x4 (x1 Lane, Gen 3), 2x 15mm NVMe, 2x Power input 	

1.1.1 Key Features

- LGA 1700 socket for 12/13th Gen. Intel® ADL & RPL Processor (65W/35W TDP)
- Intel® R680E chipset
- 2x DDR5 4800/5600MHz SODIMM. Max. up to 64GB
- Triple Independent Display by 1x DVI-I and 2x DisplayPort
- 2x Intel® 2.5GbE supporting Wake-on-LAN and PXE
- 2x Full-size Mini PCIe (1x shared by 1x mSATA), 2x SIM socket
- 2x 2.5" SATA HDD Bay (1x Internal) and with RAID 0, 1 support
- 1x M.2 (E Key, PCIe x1, USB 2.0, 2230, Support CNVi)
- 6x RS-232/422/485 (4x internal), 4x USB 3.2 Gen 2, 5x USB 3.2 Gen 1 (internal)
- 8x DI + 8x DO with isolation
- 9 to 48VDC Wide Range Power Input Supporting AT/ATX Mode
- Wide Operating Temperature -25°C to 70°C (35W CPU); -25°C to 60°C (65W CPU)
- TPM 2.0 Supported

PCIe Expansion	Model No.
1x PCIe x16 (Gen4), 2x PCIe x1 (Gen3)	<ul style="list-style-type: none"> • VCO-6000-RPL-3E
2x PCIe x16 Slot (x8 Lane, Gen 4), 1x PCIe x4 (x1 Lane, Gen 3)	<ul style="list-style-type: none"> • VCO-6000-RPL-4E

SSD/HDD Features	Model No.
1x Internal 2.5" SATA/SSD HDD Bay (support H=9mm) 1x Removable 2.5" SATA HDD Bay (support H=7mm, Hot-swappable)	<ul style="list-style-type: none"> • VCO-6000-RPL-3E • VCO-6000-RPL-4E
1x Internal 2.5" SATA/SSD HDD Bay (support H=9mm) 5x Removable 2.5" SATA HDD Bay (support H=7mm, Hot-swappable)	<ul style="list-style-type: none"> • VCO-6000-RPL-3E-4B7M • VCO-6000-RPL-4E-4B7M
1x Internal 2.5" SATA/SSD HDD Bay (support H=9mm) 1x Removable 2.5" SATA HDD Bay (support H=7mm, Hot-swappable) 2x Removable 2.5" SATA HDD Bay (support H=15mm, Hot-swappable)	<ul style="list-style-type: none"> • VCO-6000-RPL-3E-2B15M • VCO-6000-RPL-4E-2B15M
1x Internal 2.5" SATA/SSD HDD Bay (support H=9mm) 1x Removable 2.5" SATA HDD Bay (support H=7mm, Hot-swappable) 2x Removable 2.5" U.2 NVMe Bay (support H=15mm, Hot-swappable)	<ul style="list-style-type: none"> • VCO-6000-RPL-3E-2N15M • VCO-6000-RPL-4E-2N15M

2x Power input	Model No.
9~48VDC 12~48VDC (For GPU/Card Expansion)	<ul style="list-style-type: none"> • VCO-6000-RPL-3E-2PWR • VCO-6000-RPL-3E-4B7M-2PWR • VCO-6000-RPL-3E-2B15M-2PWR • VCO-6000-RPL-3E-2N15M-2PWR • VCO-6000-RPL-4E-2PWR • VCO-6000-RPL-4E-4B7M-2PWR • VCO-6000-RPL-4E-2B15M-2PWR • VCO-6000-RPL-4E-2N15M-2PWR

1.2 Hardware Specification

System

Processor

Support 12/13th Gen Intel® ADL & RPL Processor (LGA 1700, 65W/35W TDP)

- Intel® Core™ i9-13900TE/i9-12900TE, up to 24 Cores, 36MB Cache, up to 5 GHz, 35W
- Intel® Core™ i7-13700E/i7-12700E, up to 16 Core, 30MB Cache, up to 5.1 GHz, 65W
- Intel® Core™ i7-13700TE/i7-12700TE, up to 16 Cores, 30MB cache, up to 4.8 GHz, 35W
- Intel® Core™ i5-13500E/i5-12500E, up to 14 Cores, 24MB Cache, up to 4.6 GHz, 65 W
- Intel® Core™ i5-13500TE/i5-12500TE, up to 14 Core, 24MB Cache, up to 4.5 GHz, 35W
- Intel® Core™ i3-13100E/i3-12100E, up to 8 Cores, 12MB cache, up to 4.4 GHz, 60W
- Intel® Core™ i3-13100TE/i3-12100TE, up to 4 Cores, 12MB Cache, up to 4.1 GHz, 35W
- Intel® Pentium® G7400E, 2 Cores, 6MB Cache, 3.6 GHz, 46W
- Intel® Pentium® G7400TE, 2 Cores, 6MB Cache, 3.0 GHz, 35W
- Intel® Celeron® G6900E, 2 Cores, 4MB Cache, 3.0 GHz, 46W
- Intel® Celeron® G6900TE, 2 Cores, 4MB Cache, 2.4 GHz, 35W

System Chipset	Intel® R680E Express Chipset
LAN Chipset	2.5 GbE1: Intel I226, Support Wake-on-LAN and PXE, Support TSN 2.5 GbE2: Intel I226, Support Wake-on-LAN and PXE, Support TSN
Audio Codec	Realtek ALC888S
System Memory	2x 262-Pin DDR5 4800/5600MHz SODIMM. Max. up to 64GB (ECC and Non-ECC)
Graphics	Intel® UHD Graphics 770/710
BIOS	AMI 256Mbit SPI BIOS
Watchdog	Software Programmable Supports 1~255 sec. System Reset
TPM	TPM 2.0

Display

DisplayPort	2x DisplayPort, Support resolution 5120 x 3200, Up to 7680 x 4320
DVI	1x DVI-I, support resolution 1920 x 1200
Multiple Display	Triple Display
VGA	Yes (by optional split cable)

Storage	M.2	SIM Socket	
VCO-6000-RPL-3E-4B7M VCO-6000-RPL-3E-4B7M-2PWR VCO-6000-RPL-4E-4B7M VCO-6000-RPL-4E-4B7M-2PWR	1x M.2 B Key, 2242/3042/3052 (PCIe x2, Support AI Module/NVMe Storage) (PCIe x1 & USB 3.2 Gen1, Support 4G/5G)	2x External SIM socket (Mini PCIe attached)	1x Internal 2.5" SATA/SSD HDD Bay (support H=9mm) 5x Removable 2.5" SATA HDD Bay (support H=7mm, Hot-swappable)
VCO-6000-RPL-3E-2B15M VCO-6000-RPL-3E-2B15M-2PWR VCO-6000-RPL-4E-2B15M VCO-6000-RPL-4E-2B15M-2PWR			1x Internal 2.5" SATA/SSD HDD Bay (support H=9mm) 1x Removable 2.5" SATA HDD Bay (support H=7mm, Hot-swappable) 2x Removable 2.5" SATA HDD Bay (support H=15mm, Hot-swappable,)
VCO-6000-RPL-3E-2N15M VCO-6000-RPL-3E-2N15M-2PWR VCO-6000-RPL-4E-2N15M VCO-6000-RPL-4E-2N15M-2PWR			1x Internal 2.5" SATA/SSD HDD Bay (support H=9mm) 1x Removable 2.5" SATA HDD Bay (support H=7mm, Hot-swappable) 2x Removable 2.5" U.2 NVMe Bay (support H=15mm, Hot-swappable)

Expansion

Mini PCIe	1x Full-size Mini PCIe (1x shared by 1x mSATA)	
PCIe	<ul style="list-style-type: none"> 1x PCIe x16 (Gen4), 2x PCIe x1 (Gen3) : Model No : VCO-6000-RPL-3E VCO-6000-RPL-3E-4B7M VCO-6000-RPL-3E-2B15M VCO-6000-RPL-3E-2N15M VCO-6000-RPL-3E-2PWR VCO-6000-RPL-3E-4B7M-2PWR VCO-6000-RPL-3E-2B15M-2PWR VCO-6000-RPL-3E-2N15M-2PWR 	<ul style="list-style-type: none"> 2x PCIe x16 Slot (x8 Lane, Gen 4), 1x PCIe x4 (x1 Lane, Gen 3) : Model No : VCO-6000-RPL-4E VCO-6000-RPL-4E-4B7M VCO-6000-RPL-4E-2B15M VCO-6000-RPL-4E-2N15M VCO-6000-RPL-4E-2PWR VCO-6000-RPL-4E-4B7M-2PWR VCO-6000-RPL-4E-2B15M-2PWR VCO-6000-RPL-4E-2N15M-2PWR

I/O

COM	2x RS-232/422/485 ; 6x RS-232/422/485 (internal)
DIO	8 in / 8 out (Isolated)
LAN	2x RJ45
Universal I/O Bracket	2x Universal I/O Bracket (By mini PCIe interface)
USB	4x USB 3.2 Gen 2 (10 Gbps) 5x USB 3.2 Gen 1 (5 Gbps, Internal) 1x USB 3.2 Gen 1 header (5 Gbps, internal)
Others	4x WiFi Antenna Holes 1x Power Switch, 1x AT/ATX Switch, 1x Remote Power On/Off 1x PC/Car Mode Switch, 1x Delay Time Switch 1x Removable CMOS Battery (internal) 1x 6CM FAN Module (Optional)

Operating System

Windows	Windows 10/11
Linux	Linux kernel

Power

Power Adapter	Optional AC/DC 24V/9.2A, 220W Optional AC/DC 24V/11.67A, 280W (GPU/Card Expansion) Optional AC/DC 24V/15A, 360W (i7/i9 CPU/GPU/Card Expansion)
Power Mode	AT, ATX
Power Ignition Sensing	Power Ignition Management
Power Supply Voltage	9~48VDC 12~48VDC (Optional, For GPU/Card Expansion) (optional)
Power Connector	5-pin Terminal Block 4-pin Terminal Block (optional)
Power Protection	OVP (Over Voltage Protection); OCP (Over Current Protection) Reserve Protection

Environment

Operating Temp.	-25°C to 70°C (35W CPU) -25°C to 60°C (65W CPU)
Storage Temp.	-30°C to 85°C
Relative Humidity	10% to 95% (non-condensing)
Standards / Certification	CE, FCC Class A
Vibration	With SSD: 3 Grms, 5 - 500 Hz, 0.5 hr/axis With HDD: 1 Grms, 5 - 500 Hz, 0.5 hr/axis
Shock	With SSD: 20G, half sine, 11ms

Physical

Construction	Extruded Aluminum with Heavy Duty Metal
Dimension	<ul style="list-style-type: none"> VCO-6000-RPL-3E Series : 157 (W) x 340 (D) x 240 (H) mm VCO-6000-RPL-4E Series : 177 (W) x 340 (D) x 240 (H) mm
Mounting	Wall Mounting

1.3 System I/O

1.3.1 VCO-6000-RPL-3E

ATX power on/off switch

Press to power-on or power-off the system

DC IN

Used to plug a DC power input with terminal Block

Digital I/O Terminal Block

The Digital I/O terminal block supports 8 digital input and 8 digital output

Antenna hole

Used to connect an antenna for optional Mini-PCIe WiFi module

USB 3.2 Gen 2 port (10 Gbps)

Used to connect USB 3.2 device

Removable HDD

Removable 2.5" SATA HDD Bay (support H=7mm, hot-swappable)

DisplayPort

Used to connect a DisplayPort monitor

LAN Port

Used to connect the system to a local area network

DVI-I port

Used to connect a DVI monitor or connect optional split cable for dual display mode

COM port

COM1 & COM2 support RS232/422/485 serial device

Remote Power on/off Terminal Block

Used to plug a remote power on/off terminal block

2x Universal I/O Bracket

Hot-Swappable Fan

Easily removed for replacements or quick maintenance in the field.

Front Panel

Rear Panel

Top Panel

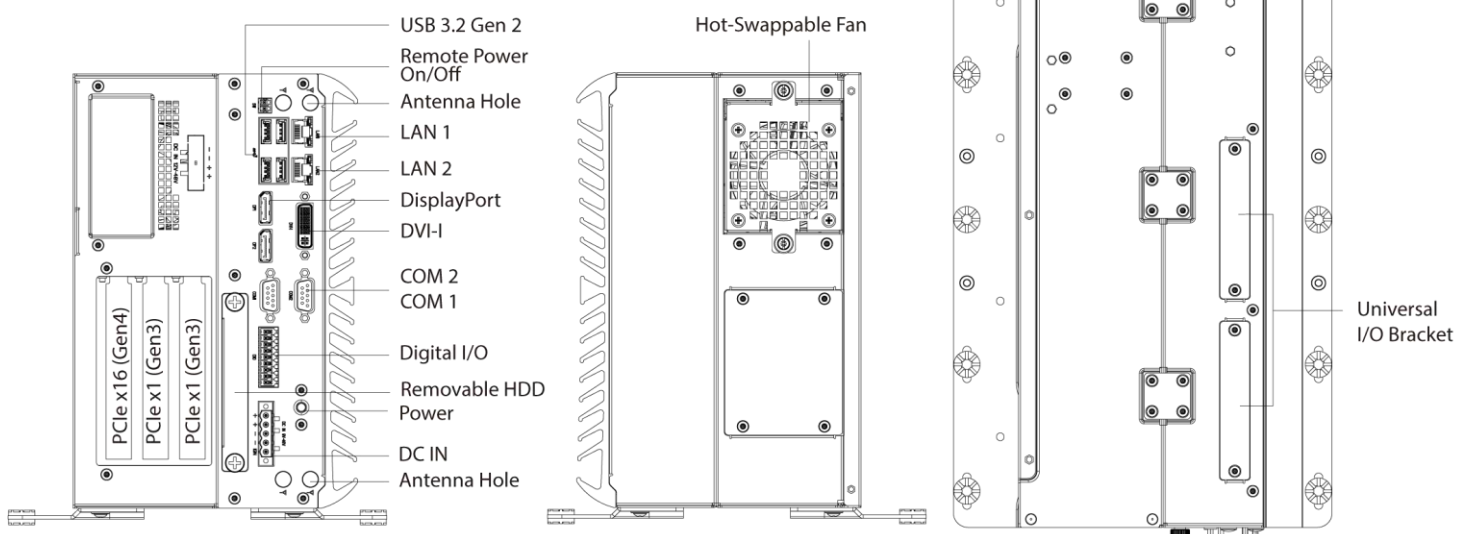

VCO-6000-RPL-3E Series Expansion

VCO-6000-RPL-3E / VCO-6000-RPL-3E-4B7M / VCO-6000-RPL-3E-2B15M / VCO-6000-RPL-3E-2N15M / VCO-6000-RPL-3E-2PWR / VCO-6000-RPL-3E-4B7M-2PWR / VCO-6000-RPL-3E-2B15M-2PWR / VCO-6000-RPL-3E-2N15M-2PWR

Storage (optional)

- 4B7M:
4x Removable 2.5" SATA HDD Bay
- 2B15M:
2x Removable 2.5" SATA HDD Bay
- 2N15M:
2x Removable 2.5" U.2 NVMe Bay

DC IN 12 ~ 48VDC (optional)

- 12 ~ 48VDC (For GPU/Card Expansion)

FAN (optional)

- Internal 6 CM FAN (Optional)

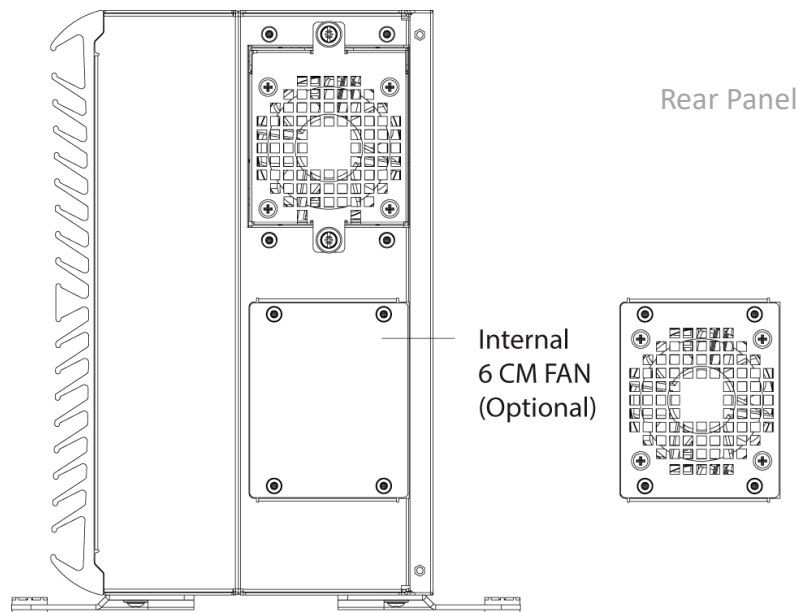
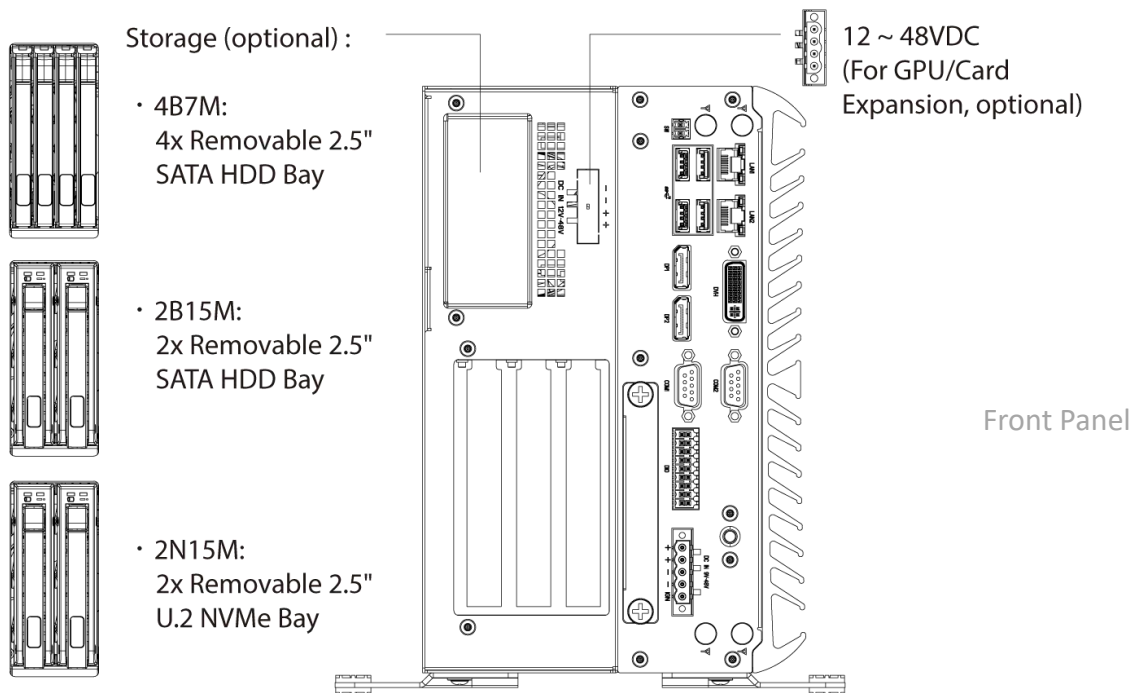

1.3.2 VCO-6000-RPL-4E

ATX power on/off switch

Press to power-on or power-off the system

DC IN

Used to plug a DC power input with terminal Block

Digital I/O Terminal Block

The Digital I/O terminal block supports 8 digital input and 8 digital output

Antenna hole

Used to connect an antenna for optional Mini-PCIe WiFi module

USB 3.2 Gen 2 port (10 Gbps)

Used to connect USB 3.2 device

Removable HDD

Removable 2.5" SATA HDD Bay (support H=7mm, hot-swappable)

DisplayPort

Used to connect a DisplayPort monitor

LAN Port

Used to connect the system to a local area network

DVI-I port

Used to connect a DVI monitor or connect optional split cable for dual display mode

COM port

COM1 & COM2 support RS232/422/485 serial device

Remote Power on/off Terminal Block

Used to plug a remote power on/off terminal block

2x Universal I/O Bracket

Hot-Swappable Fan

Easily removed for replacements or quick maintenance in the field.

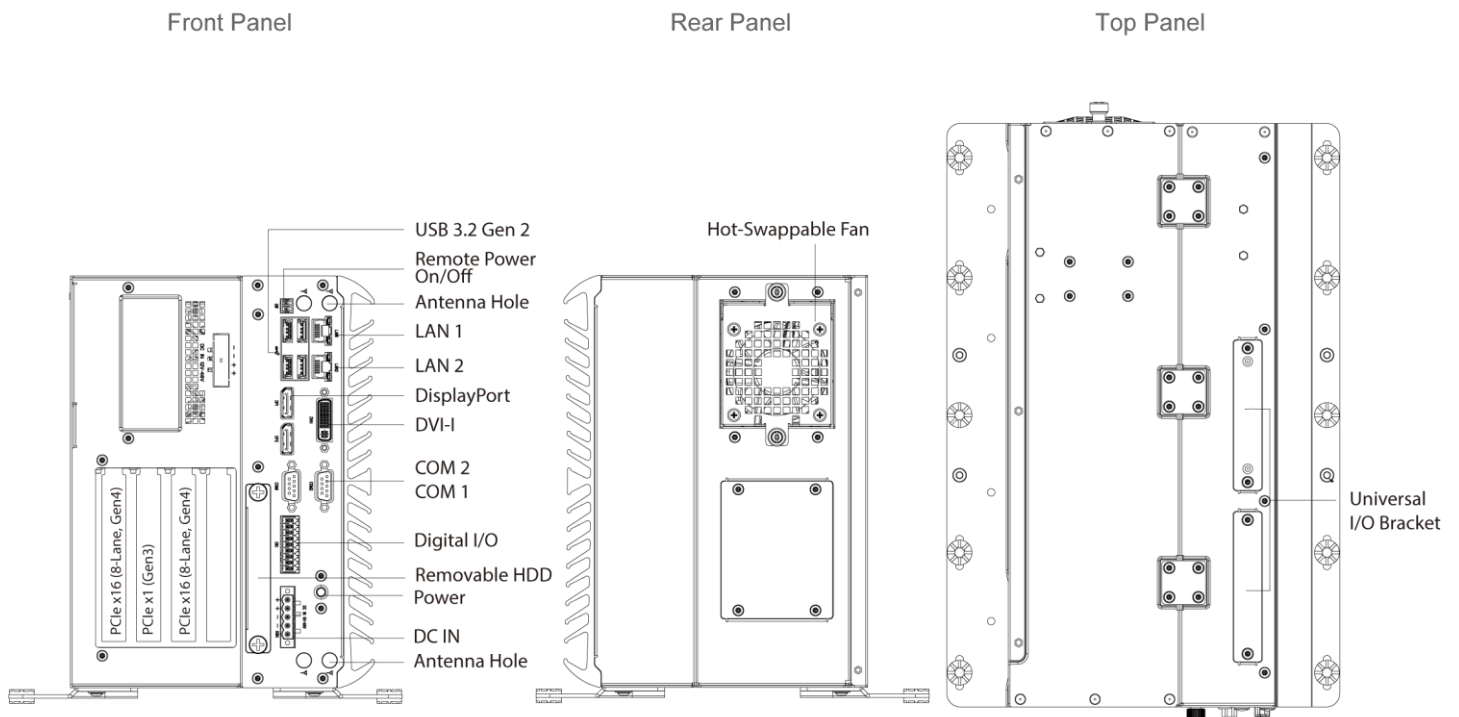

VCO-6000-RPL-4E Series Expansion

VCO-6000-RPL-4E / VCO-6000-RPL-4E-4B7M / VCO-6000-RPL-4E-2B15M / VCO-6000-RPL-4E-2N15M / VCO-6000-RPL-4E-2PWR / VCO-6000-RPL-4E-4B7M-2PWR / VCO-6000-RPL-4E-2B15M-2PWR / VCO-6000-RPL-4E-2N15M-2PWR

Storage (optional)

- 4B7M:
4x Removable 2.5" SATA HDD Bay
- 2B15M:
2x Removable 2.5" SATA HDD Bay
- 2N15M:
2x Removable 2.5" U.2 NVMe Bay

DC IN 12 ~ 48VDC (optional)

- 12 ~ 48VDC (For GPU/Card Expansion)

FAN (optional)

- Internal 6 CM FAN (Optional)

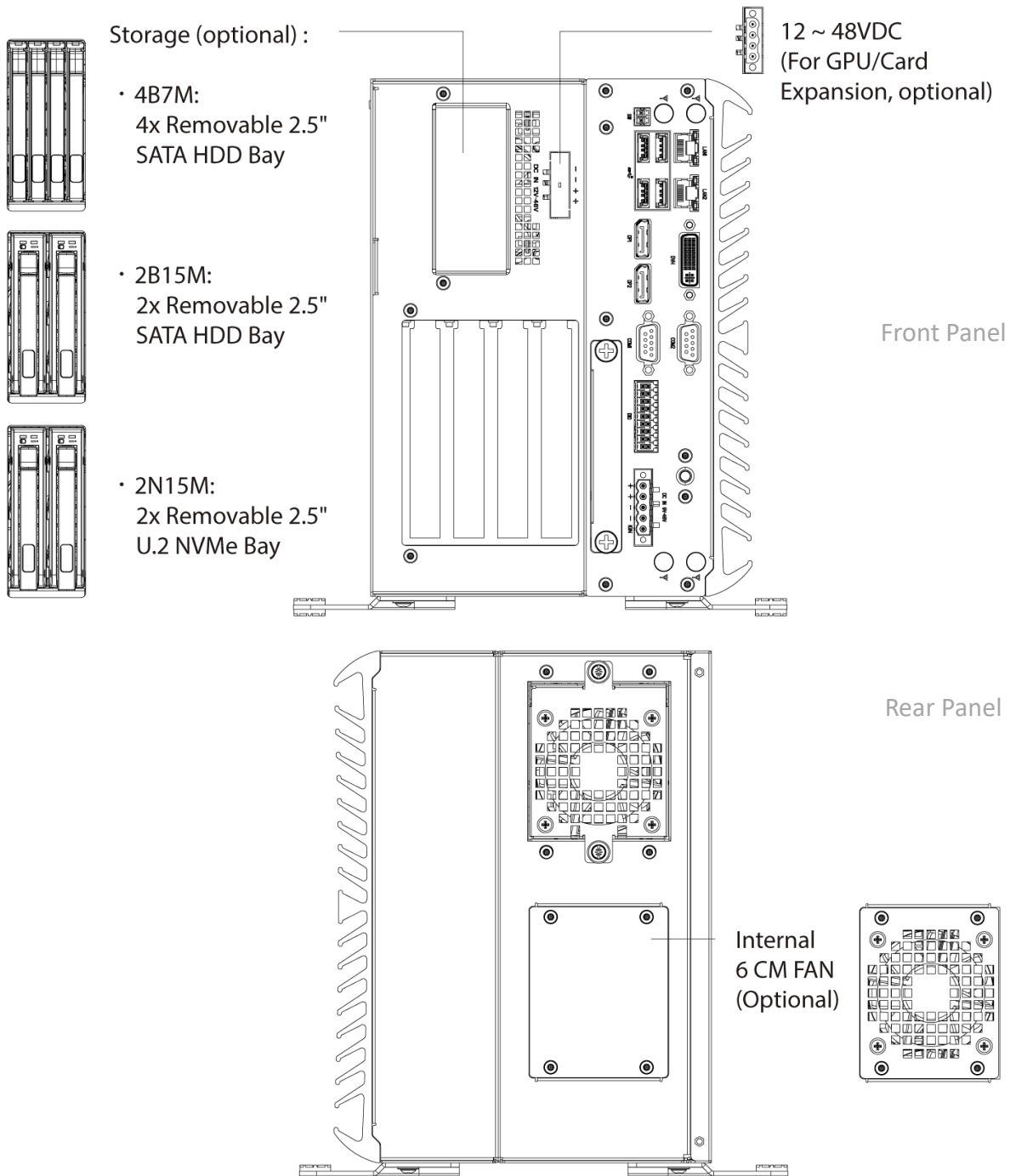

1.4 Mechanical Dimensions

1.4.1 VCO-6000-RPL-3E Series

Unit: mm

VCO-6000-RPL-3E / VCO-6000-RPL-3E-4B7M / VCO-6000-RPL-3E-2B15M / VCO-6000-RPL-3E-2N15M /
 VCO-6000-RPL-3E-2PWR / VCO-6000-RPL-3E-4B7M-2PWR / VCO-6000-RPL-3E-2B15M-2PWR /
 VCO-6000-RPL-3E-2N15M-2PWR

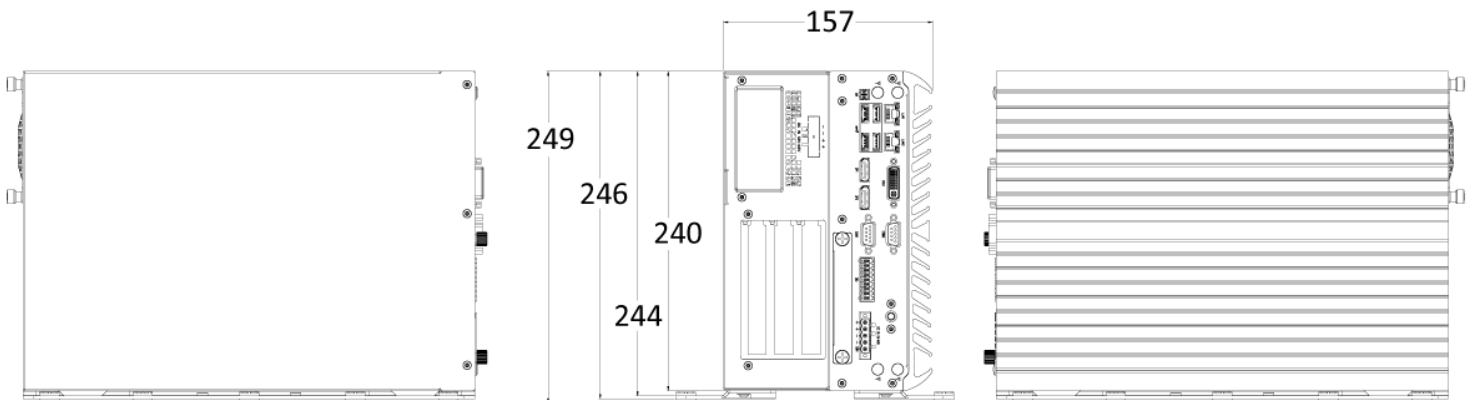
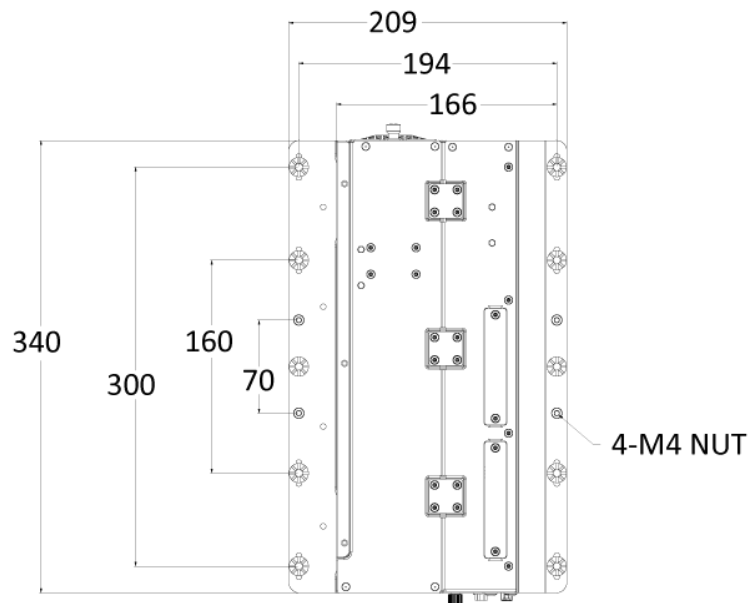

1.4.2 VCO-6000-RPL-4E Series

Unit: mm

VCO-6000-RPL-4E / VCO-6000-RPL-4E-4B7M / VCO-6000-RPL-4E-2B15M / VCO-6000-RPL-4E-2N15M /
 VCO-6000-RPL-4E-2PWR / VCO-6000-RPL-4E-4B7M-2PWR / VCO-6000-RPL-4E-2B15M-2PWR /
 VCO-6000-RPL-4E-2N15M-2PWR

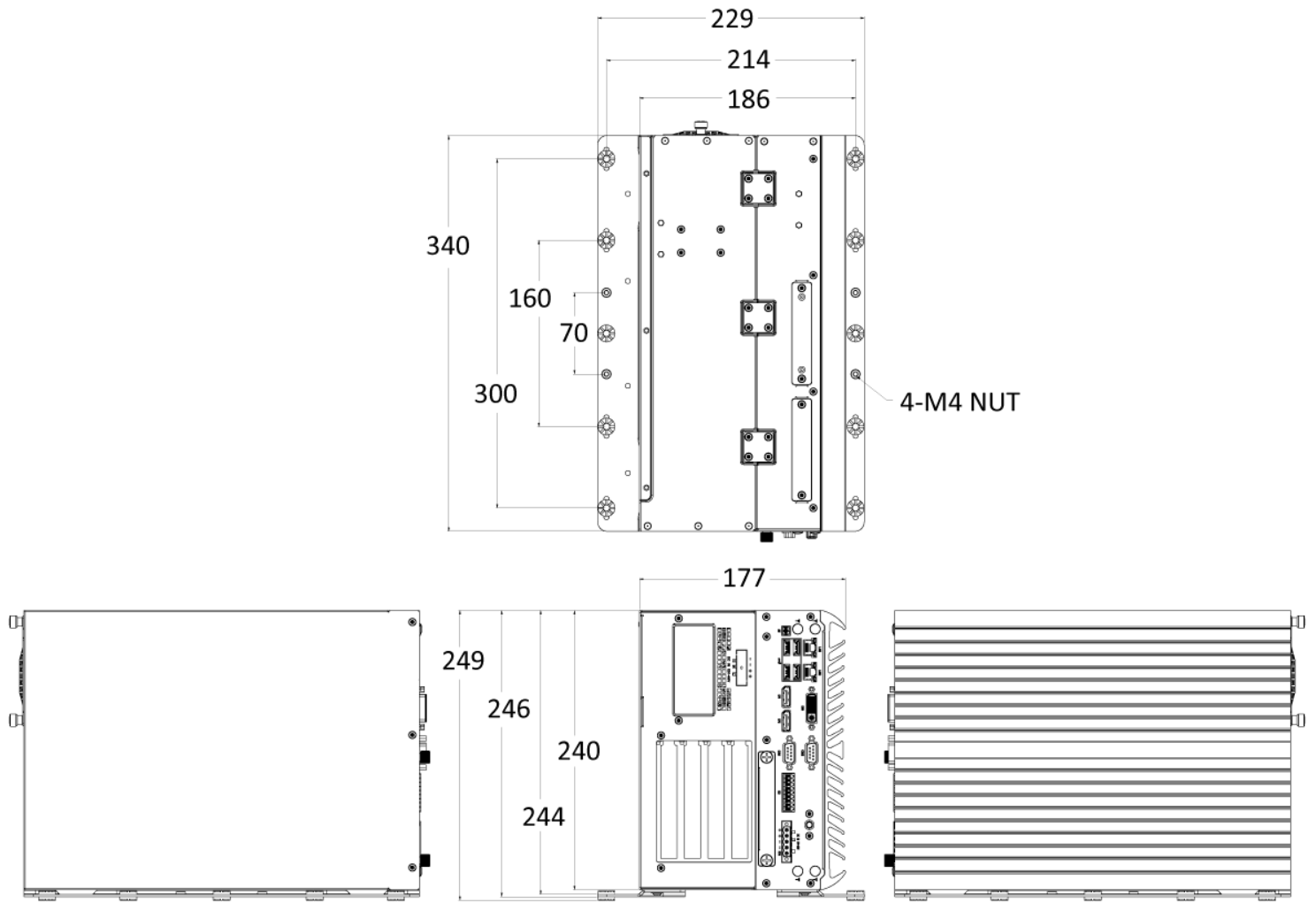

Chapter 2

Mechanical Specifications

2.1 Switch and Connector Locations

2.1.1 Top View

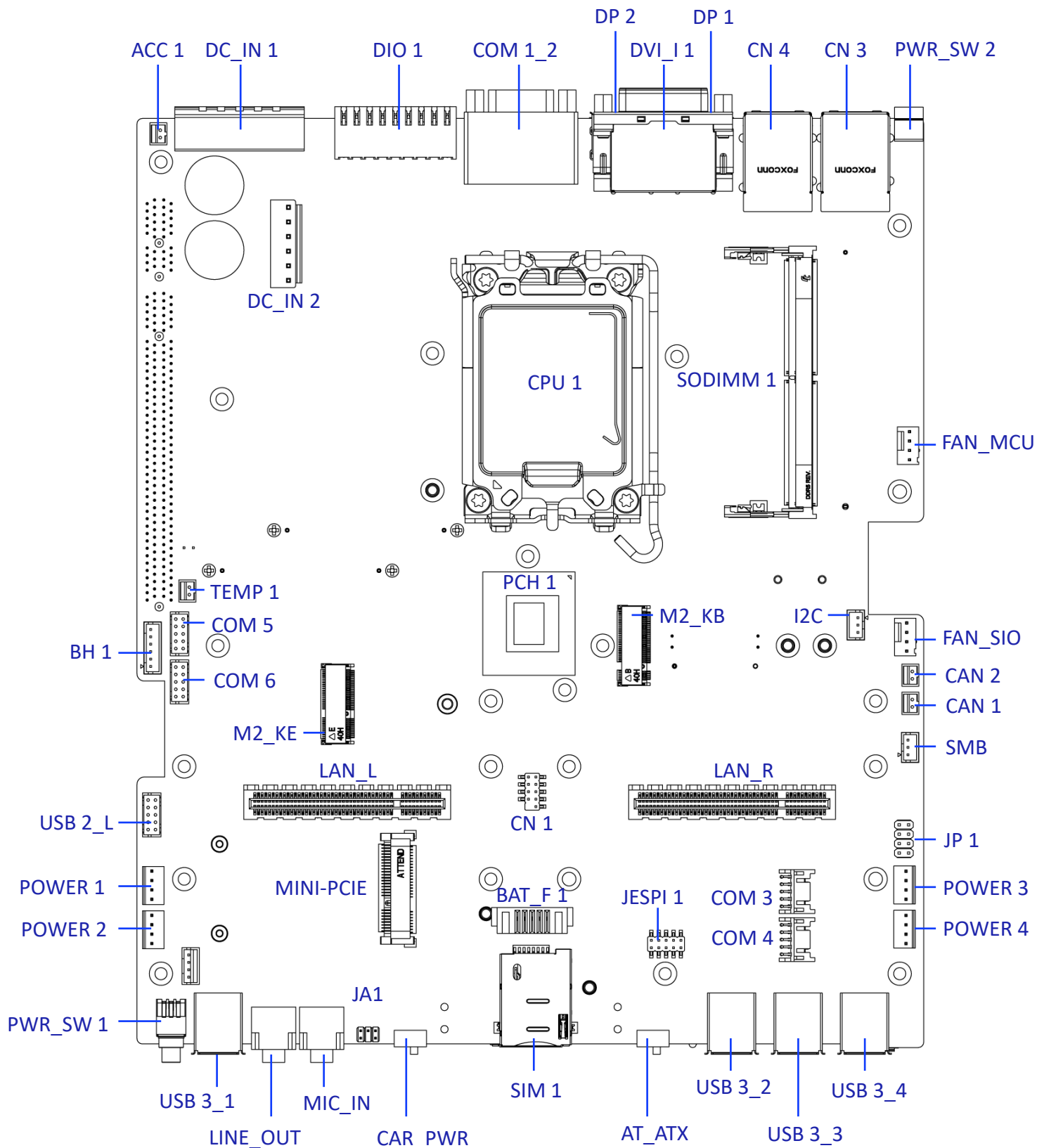

2.1.2 Bottom View

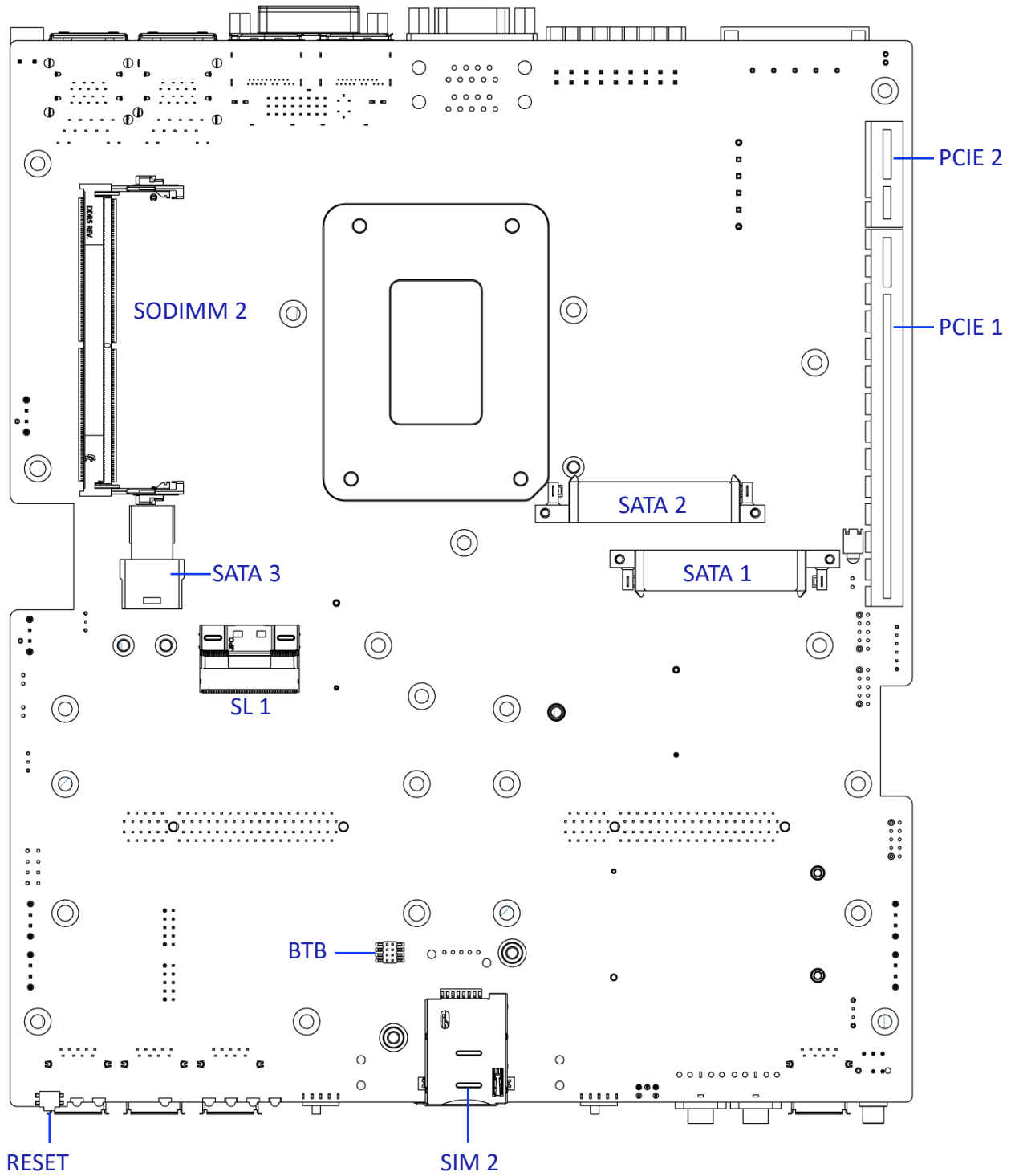

2.2 Connector / Switch Definition

Connector Location	Definition
AT_ATX	AT / ATX Power Mode Switch
PWR_SW1,2,3	Power Switch
RESET	Reset Switch
DC_IN1	5-pin DC +9~48V Power Input Connector
DC_IN2	6-pin DC +9~48V Power Input Connector
DIO1	8DI / 8DO Connector
COM1-6	RS232 / RS422 / RS485 Connector
DP1,2	DP Connector
DVI_I1	DVI-I Connector
CN3,4	LAN and USB3.2 GEN 2 Ports X2
FAN_CPU,FAN_SIO	Smart FAN Connector
PWR1-4	+12V / 5V Power Connector
USB3_1-4	USB 3.2 Gen 2 、 USB 3.2 Gen 1 、 USB2.0
SIM1, SIM2	SIM Card Socket
CAR_PWR	PC mode / CAR mode select
SL1	PCI-Express X8 Slimline Connector
MIC_IN	Mic-in Jack
LINE_OUT	LINE-OUT Jack
M2_KE , M2_KB	M.2 key E , key B Connector
PCIE1,2, LAN_L, LAN_R	PCI-Express X1 Slot, PCI-Express X8 Slot (PCIex4 w POE) , PCI-Express x16 Slot
MINI-PCIE	Mini PCI-Express Socket
PWR_LED	Power LED Status
HDD_LED	HDD Access LED Status
WDT_LED1	Watchdog LED Status
SATA3	SATA X 4 Port
SATA1,2	SATA with Power Connector

2.3 I/O Interface Descriptions

2.3.1 ESPI Debug Con

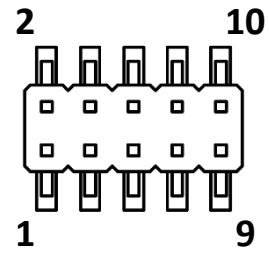
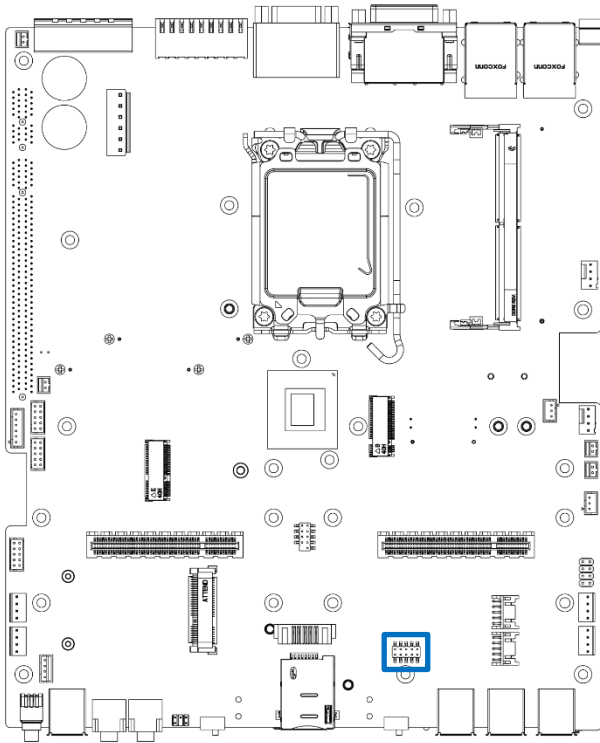

JESPI 1

Pin	Signal	Pin	Signal
1	ESPI_IO_0	2	3.3V
3	ESPI_IO_1	4	ESPI_RESET#
5	ESPI_IO_2	6	ESPI_CS#
7	ESPI_IO_3	8	ESPI_CLOCK
9	N/A	10	GND

2.3.2 Power Con

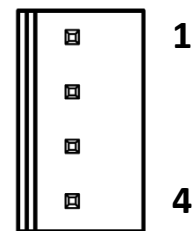
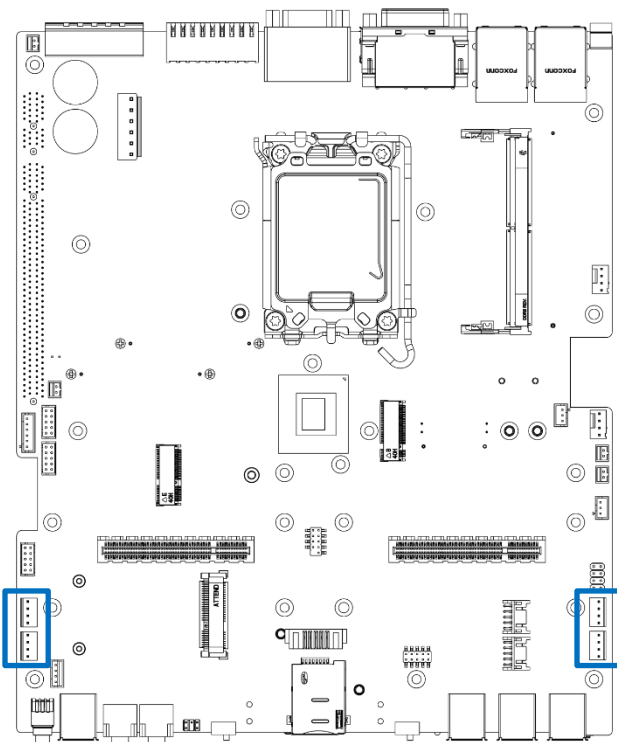

POWER 1~4

Pin	Signal
1	+5V
2	GND
3	GND
4	+12V

2.3.3 DC IN 1 : 9V ~ 48V

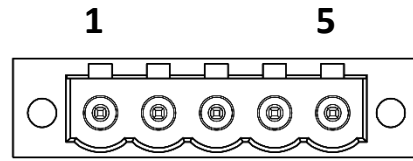
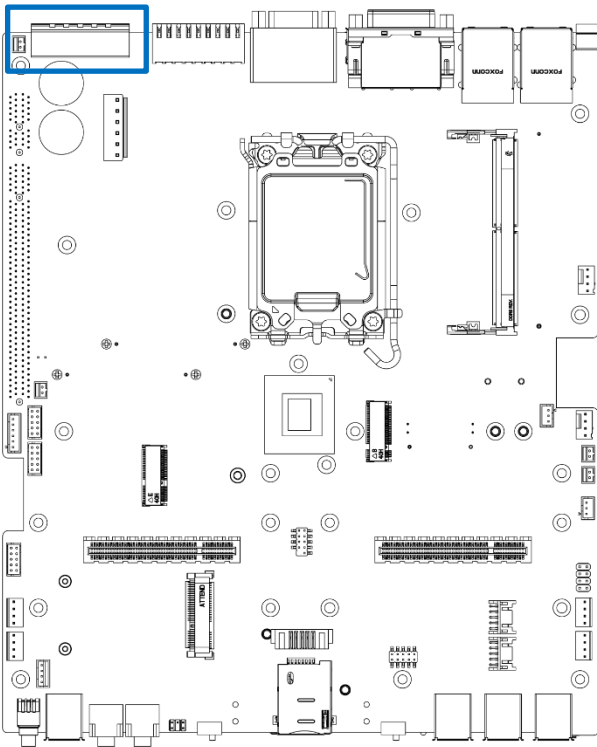

DC IN 1

Pin	Signal
1	+9V ~ +48V
2	+9V ~ +48V
3	GND
4	GND
5	IGN

2.3.4 DC IN 2 : 9V ~ 48V

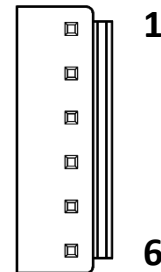
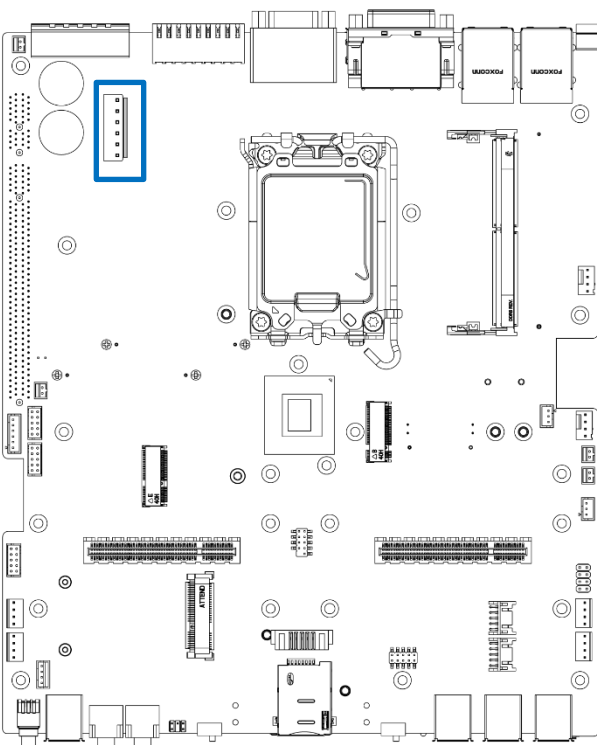

DC IN 2

Pin	Signal
1	+9V ~ +48V
2	+9V ~ +48V
3	+9V ~ +48V
4	GND
5	GND
6	GND

2.3.5 COM Con

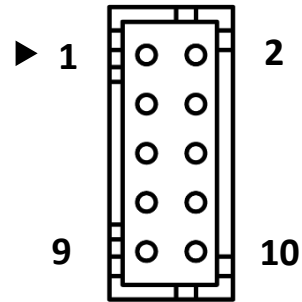
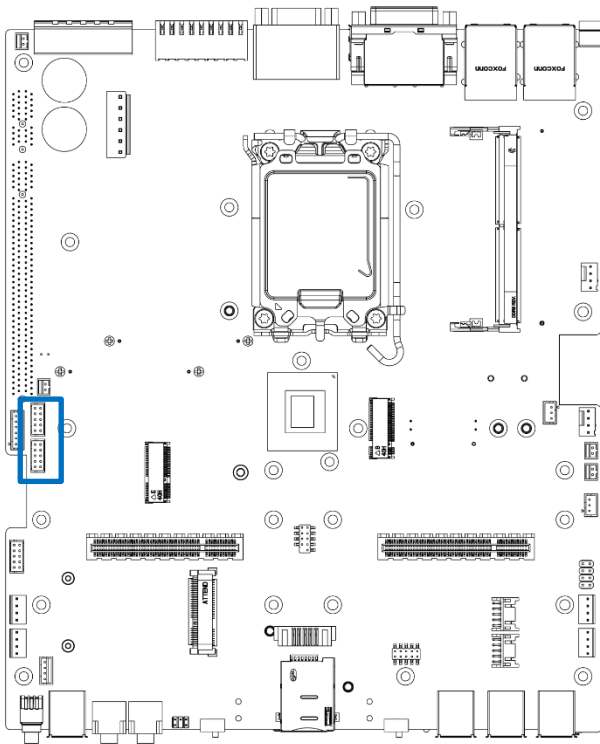

COM 5, COM 6

Pin	Signal	Pin	Signal
1	DCD#	2	DSR#
3	RXD	4	RTS#
5	TXD	6	CTS#
7	DTR#	8	RI#
9	GND	10	GND

RS232 / RS422 / RS485 Connector 2x5 10-pin box header, 2.0mm pitch

Pin	Signal	RS422 / 485 Full Duplex Definition	RS485 Half Duplex Definition
1	DCD#	TX-	DATA-
2	DSR#		
3	RxD	TX+	DATA+
4	RTS#		
5	TxD	RX+	
6	CTS#		
7	DTR#	RX-	
8	RI#		
9	GND	GND	GND
10	GND	GND	GND

COM Con

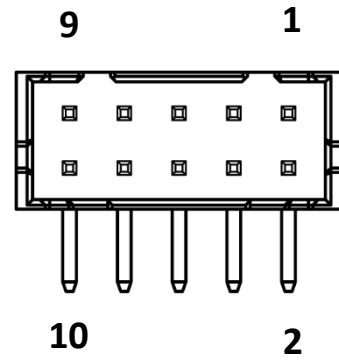
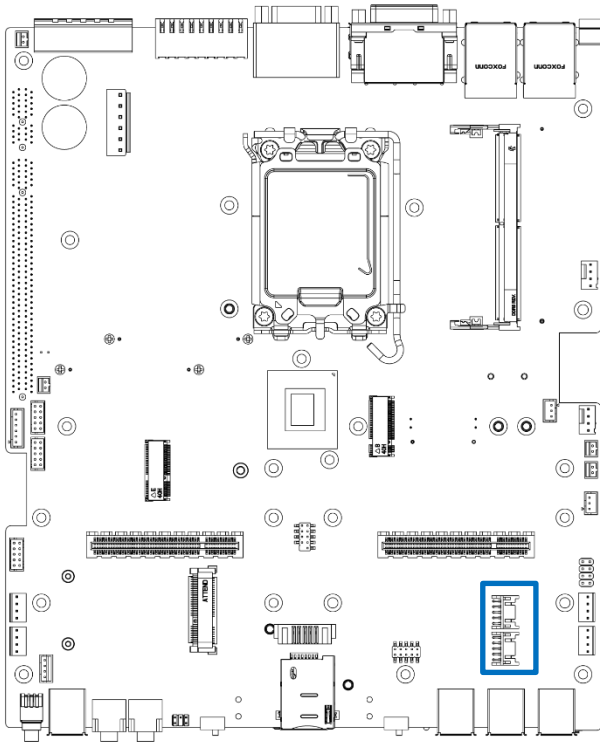

COM 3 , COM 4

Pin	Signal	Pin	Signal
1	DCD#	2	DSR#
3	RXD	4	RTS#
5	TXD	6	CTS#
7	DTR#	8	RI#
9	GND	10	GND

COM Con

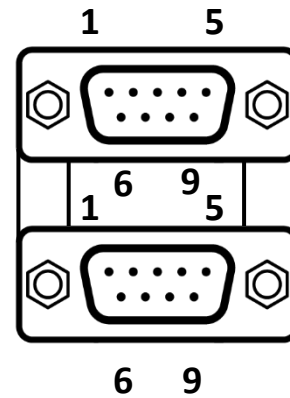
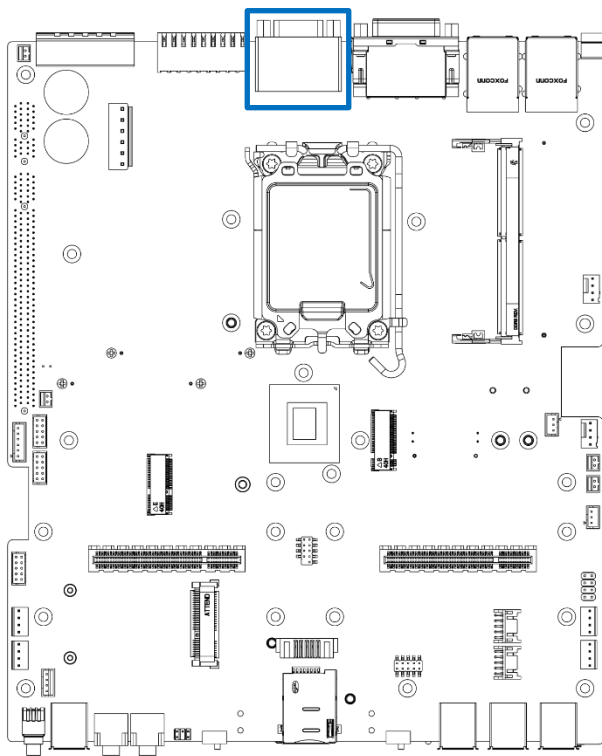

COM 1_2

RS232 / RS422 / RS485 Connector Type: 9-pin D-Sub

Pin	RS232 Definition	RS422 / 485 Full Duplex Definition	RS485 Half Duplex Definition
1	DCD#	TX-	DATA-
2	RxD	TX+	DATA+
3	TxD	RX+	
4	DTR#	RX-	
5	GND	GND	GND
6	DSR#		
7	RTS#		
8	CTS#		
9	RI#		

2.3.6 SF100 SPI Con

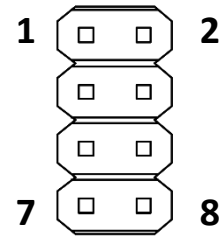
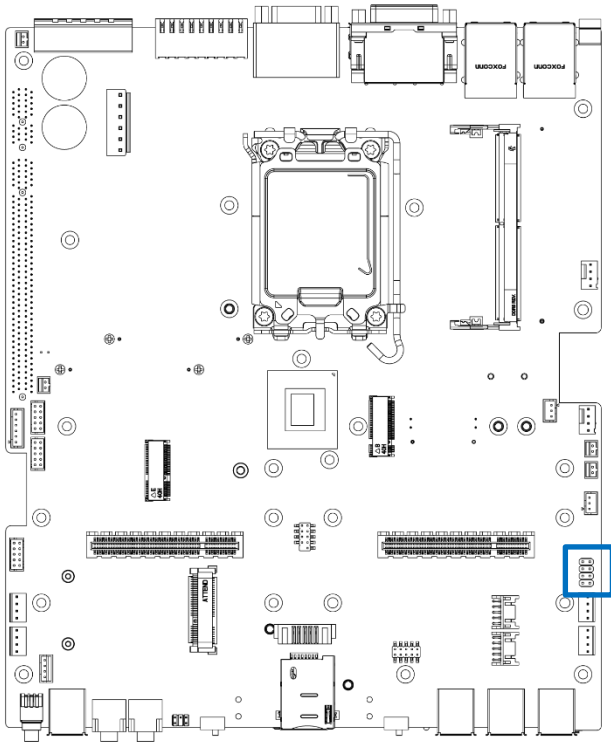

JP 1

Switch	Definition
1	Power (3V)
2	GND
3	CS#
4	CLK
5	MISO
6	MOSI
7	NC
8	SPI_GATE#

2.3.7 AT / ATX Power Mode Switch

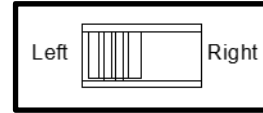
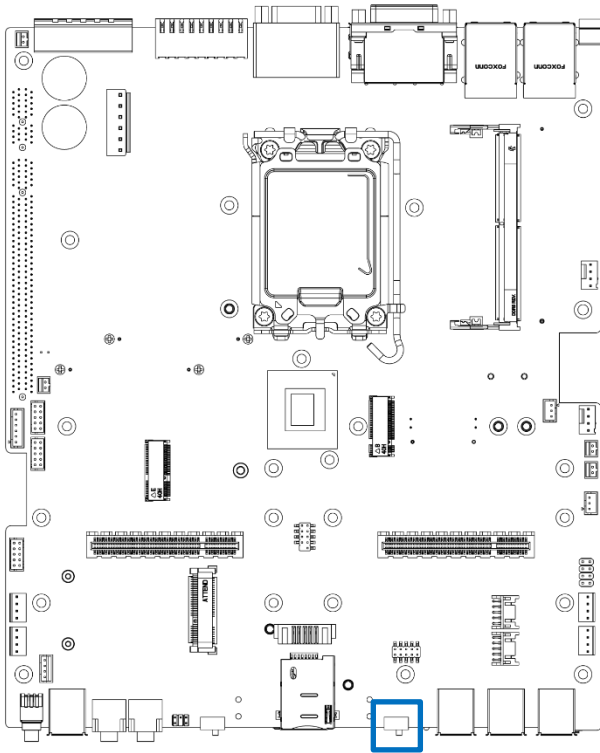

AT_ATX

Switch	Definition
1-2 (Left)	ATX Power Mode (Default)
2-3 (Right)	AT Power Mode

2.3.8 PC / Car Mode Switch

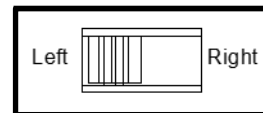
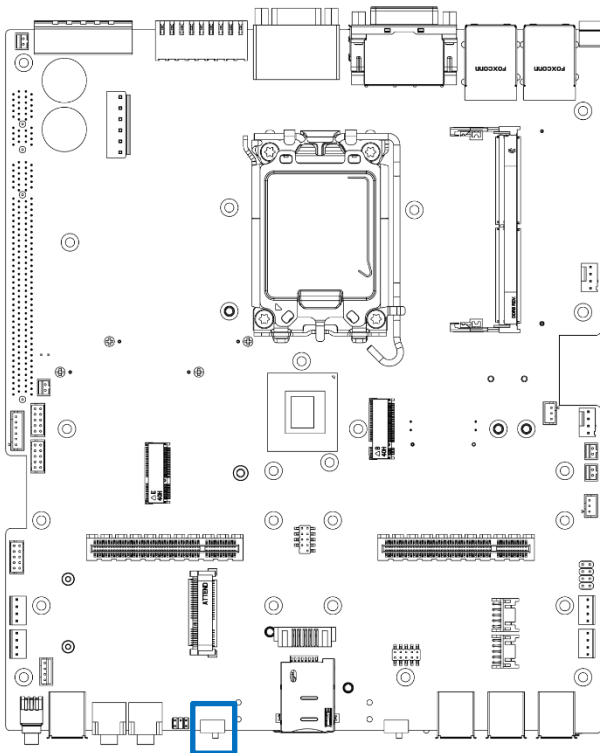

CAR_PWR

Switch	Definition
1-2 (Left)	PC Power Mode (Default)
2-3 (Right)	Power Ignition Mode

2.3.9 Line-out Jack (Green) Connector Type: 5-pin Phone Jack

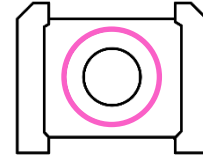
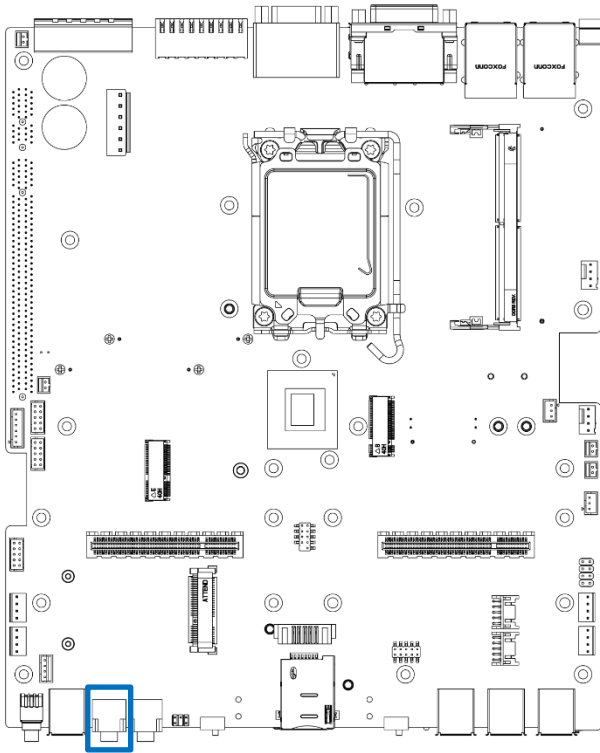

LINE_OUT

Switch	Definition
1	GND
2	OUT_R
3	GND
4	GND
5	OUT_L

2.3.10 Microphone-in Jack (Pink) Connector Type: 5-pin Phone Jack

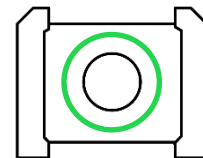
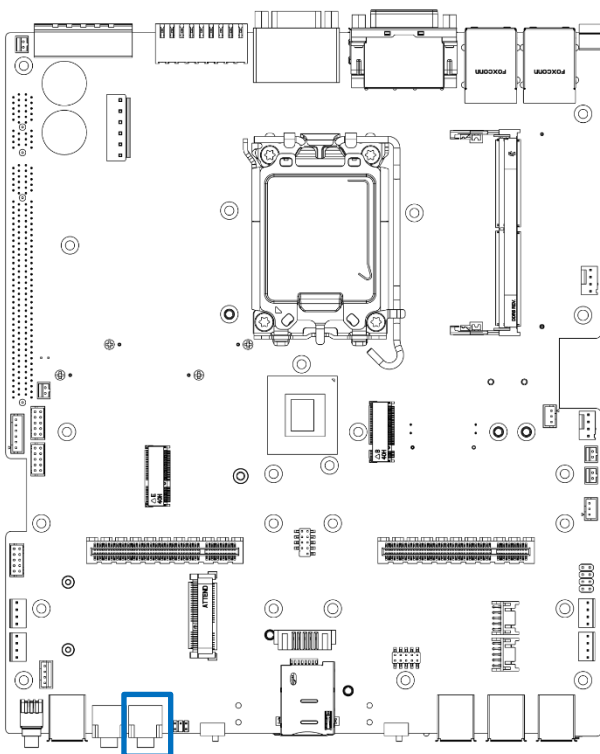

MIC_IN

Switch	Definition
1	GND
2	MIC_R
3	GND
4	GND
5	MIC_L

2.3.11 Clear BIOS Switch

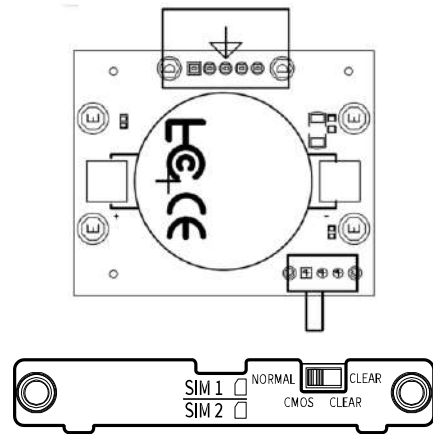
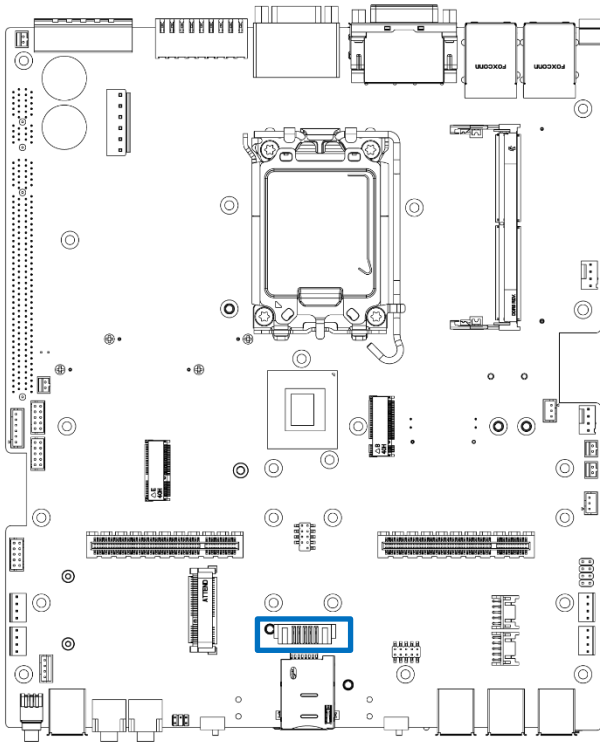

CLR_CMOS

Switch	Definition
1-2 (Left)	Normal Status (Default)
2-3 (Right)	Clear BIOS

2.3.12 Power Button

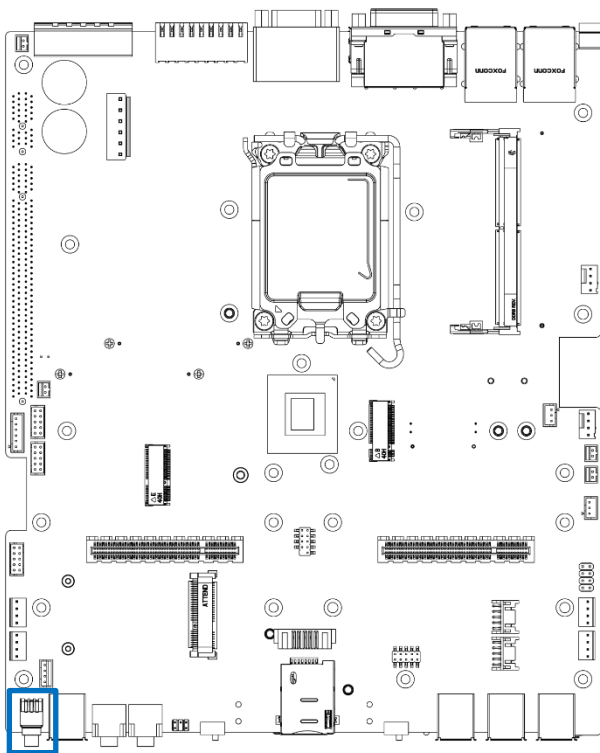

PWR_SW 1

Switch	Definition
1	NC
2	Power Button
3	NC
4	GND
5	NC
6	GND

2.3.13 Remote Power Switch Type: Terminal Block 1x2 2-pin, 3.5mm pitch

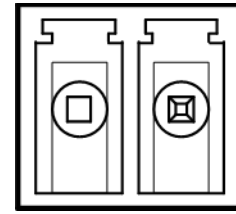
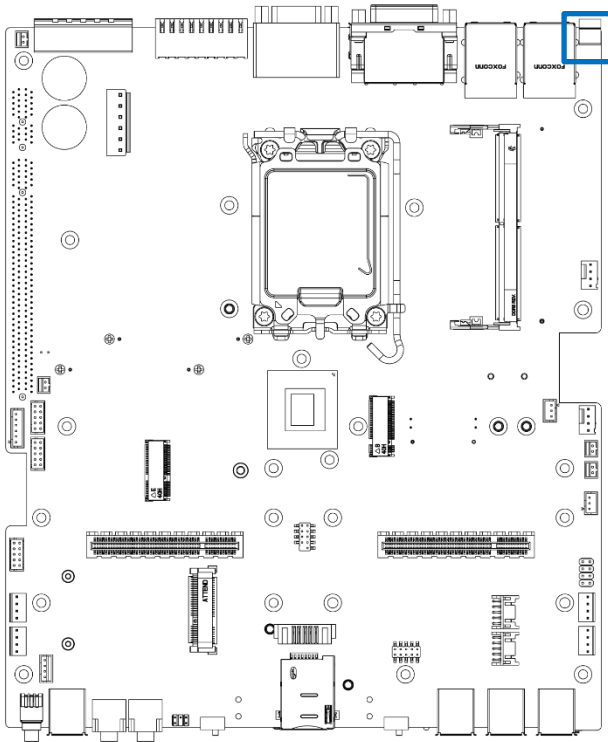

1 2

PWR_SW 2

Pin	Definition
1	Power Button
2	GND

2.3.14 For VCO-6000-RPL

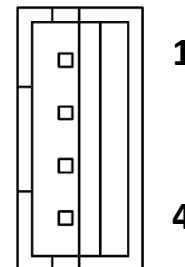
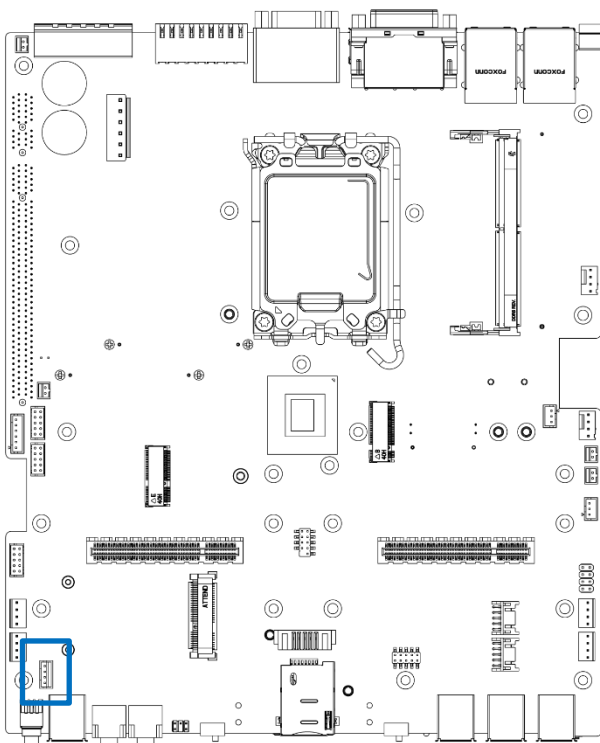

1

4

PWR_SW 3

Pin	Definition
1	Power Button
2	PWR_LED
3	HDD_LED
4	GND

2.3.15 Reset Button

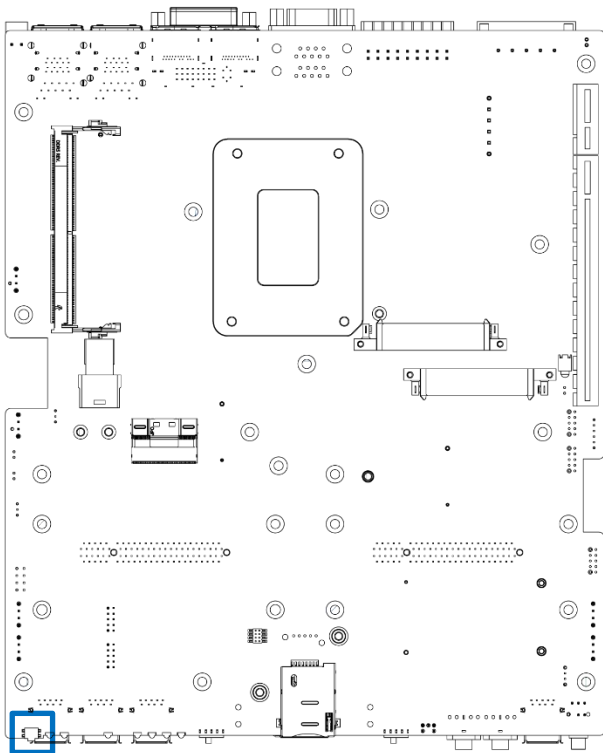

RESET

Switch	Definition
1,2	RESET
3,4	GND

2.3.16 USB 3.1 Connector, GEN2 x4 ports, Type A

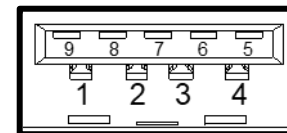
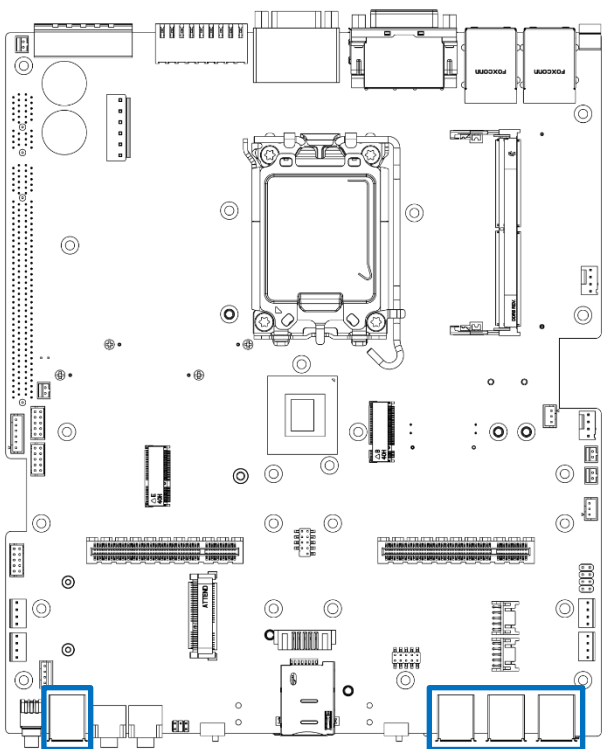

USB 3_1 , USB 3_2 , USB 3_3 , USB 3_4

Pin	Definition
1	+5V
2	USB2_D-
3	USB2_D+
4	GND
5	USB3_RX-
6	USB3_RX+
7	GND
8	USB3_TX-
9	USB3_TX+

2.3.17 USB3.0 Connector, 2x5 10-pin header, 2.0mm pitch

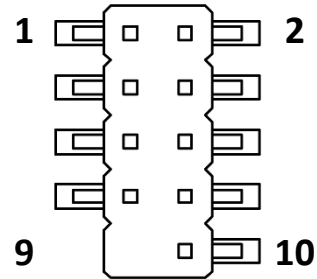
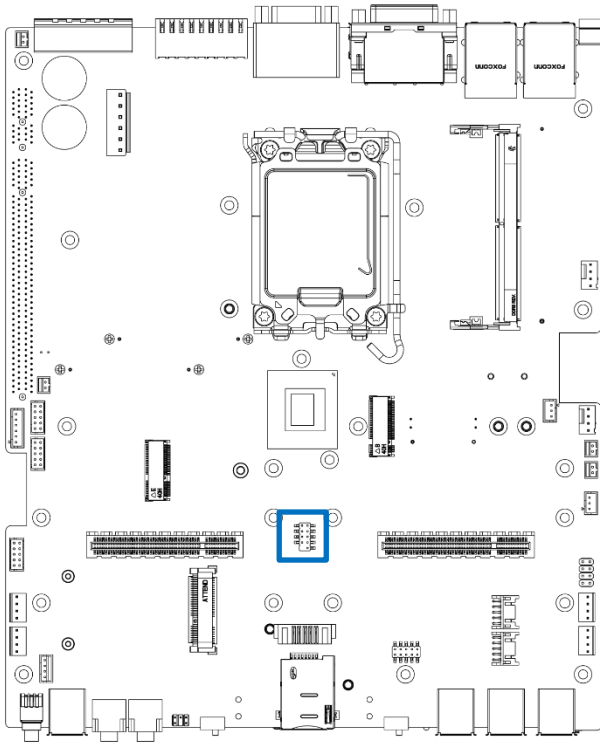

CN 1

Switch	Definition
1	+5V
2	USB3_TX-
3	USB_D-
4	USB3_TX+
5	USB_D+
6	GND
7	GND
8	USB3_RX-
9	NC
10	USB3_RX+

2.3.18 USB2.0 Connector, 2x5 10-pin box header, 2.0mm pitch

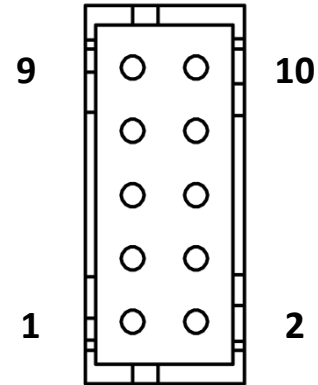
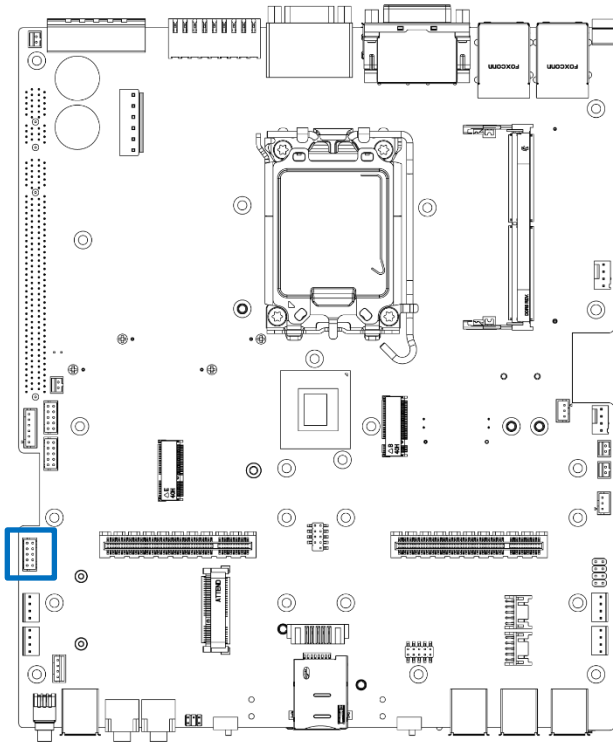

USB 2_L

Switch	Definition
1	NC
2	+5V
3	NC
4	USB2_D-
5	NC
6	USB2_D+
7	NC
8	GND
9	NC
10	GND

2.3.19 LAN and USB 3.1 GEN 2 Ports Connector Type: RJ45 port with LEDs and dual USB 3.1 ports

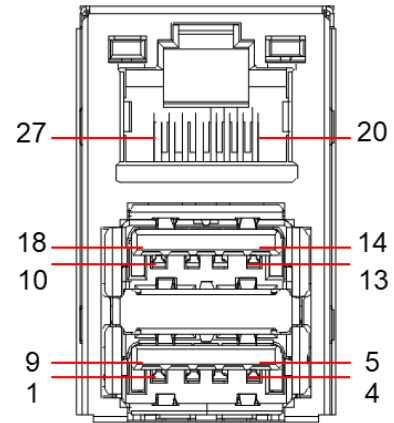
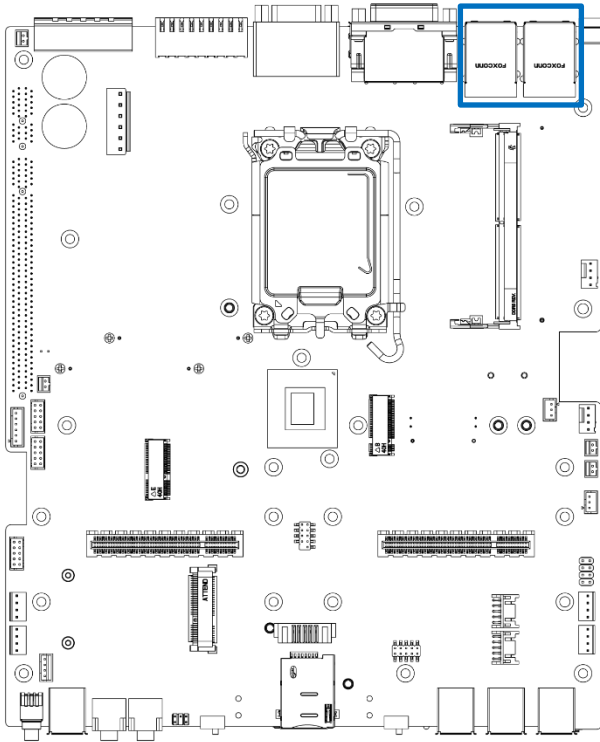

CN3, CN4

Pin	Definition	Pin	Definition	Pin	Definition
1	+5V	10	+5V	20	LAN1_MDI0P
2	USB2_D1-	11	USB2_D2-	21	LAN1_MDI0N
3	USB2_D1+	12	USB2_D2+	22	LAN1_MDI1P
4	GND	13	GND	23	LAN1_MDI2P
5	USB3_RX1-	14	USB3_RX2-	24	LAN1_MDI2N
6	USB3_RX1+	15	USB3_RX2+	25	LAN1_MDI1N
7	GND	16	GND	26	LAN1_MDI3P
8	USB3_TX1-	17	USB3_TX2-	27	LAN1_MDI3N
9	USB3_TX1+	18	USB3_TX2+		

2.3.20 DVI-I Connector

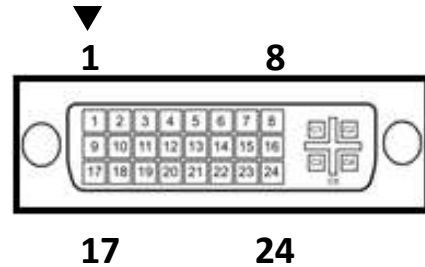
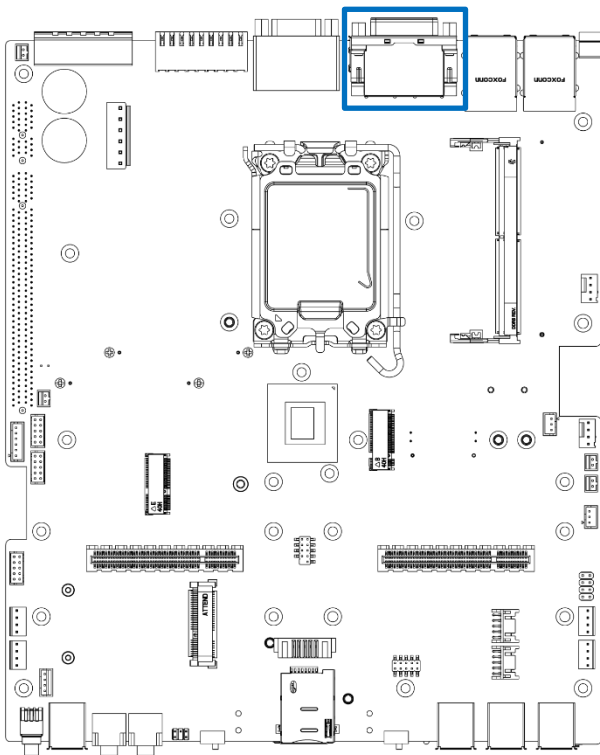

DVI_I 1

Pin	Definition	Pin	Definition
1	DVI_TX2-	16	DVI Hot Plug Detect
2	DVI_TX2+	17	DVI_TX0-
3	GND	18	DVI_TX0+
4	NC	19	GND
5	NC	20	VGA_DDC_CLOCK
6	DVI_DDC_CLOCK	21	VGA_DDC_DATA
7	DVI_DDC_DATA	22	GND
8	VGA VSYNC	23	DVI_TXCLK+
9	DVI_TX1-	24	DVI_TXCLK-
10	DVI_TX1+	C1	VGA_RED
11	GND	C2	VGA_GREEN
12	NC	C3	VGA_BLUE
13	NC	C4	VGA_HSYNC
14	+5V	C5	GND
15	GND		

2.3.21 Display Port Connector

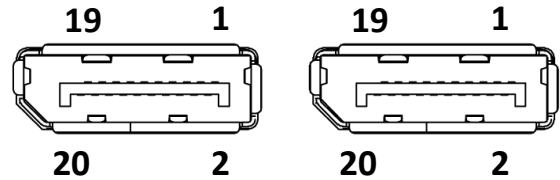
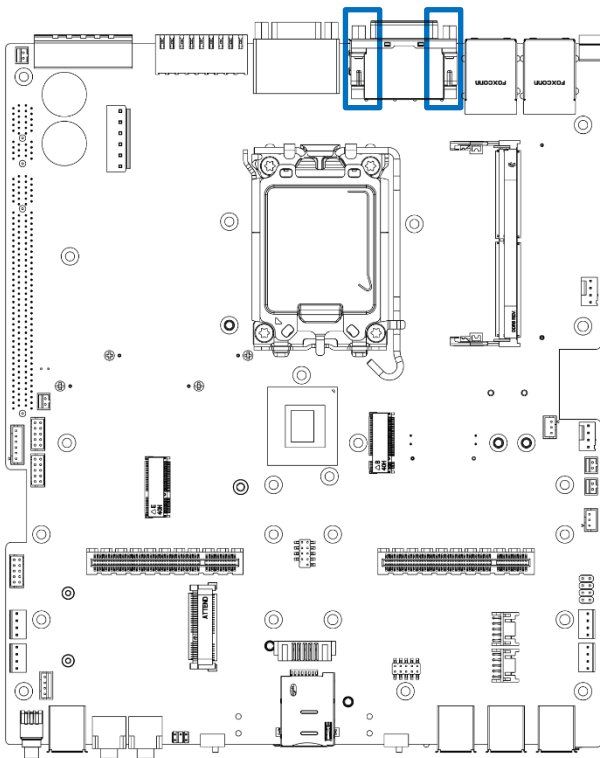

DP 1, DP 2

Pin	Definition	Pin	Definition
1	DP_LANE0_P	11	GND
2	GND	12	DP_LANE3_N
3	DP_LANE0_N	13	GND
4	DP_LANE1_P	14	GND
5	GND	15	DP_AUX_P
6	DP_LANE1_N	16	GND
7	DP_LANE2_P	17	DP_AUX_N
8	GND	18	DP_HPD
9	DP_LANE2_N	19	GND
10	DP_LANE3_P	20	+3.3V

2.3.22 Digital Input / Output Connector Type: Terminal Block 2x9 18-pin, 3.5mm pitch

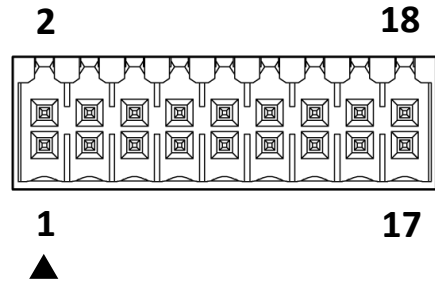
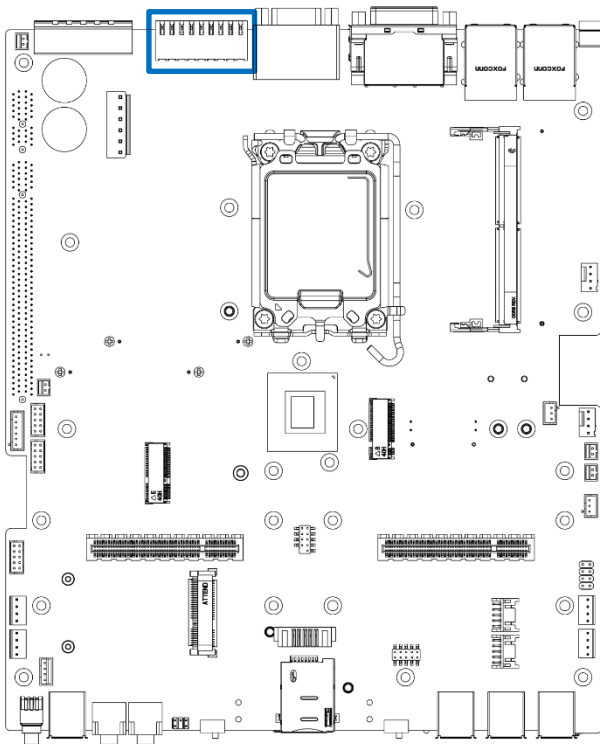

DIO

Pin	Definition	Pin	Definition
1	DIN1	2	DOUT1
3	DIN2	4	DOUT2
5	DIN3	6	DOUT3
7	DIN4	8	DOUT4
9	DIN5	10	DOUT5
11	DIN6	12	DOUT6
13	DIN7	14	DOUT7
15	DIN8	16	DOUT8
17	DC power input (+5V~+24V)	18	GND

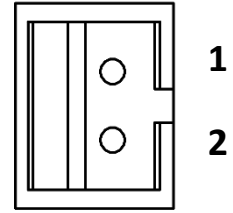
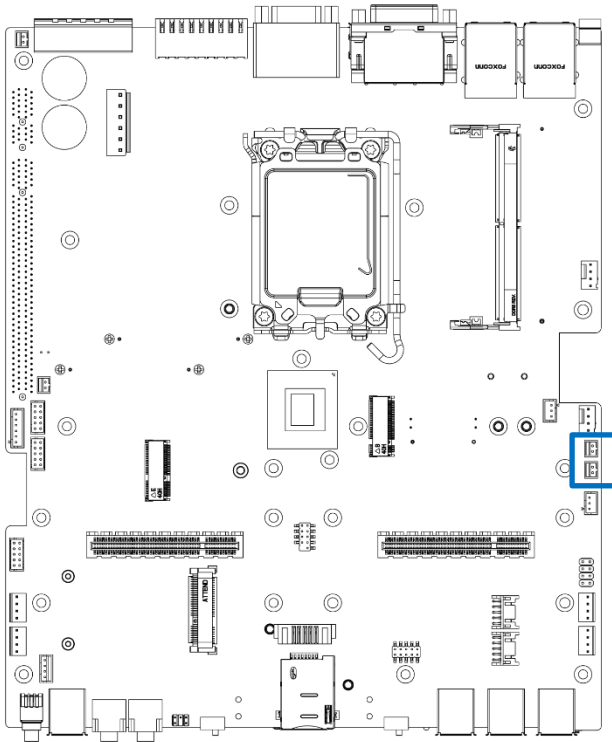

CAN1 CAN2

Pin	Signal
1	CAN_H
2	CAN_L

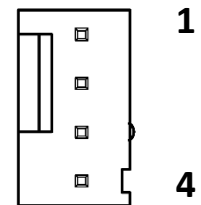
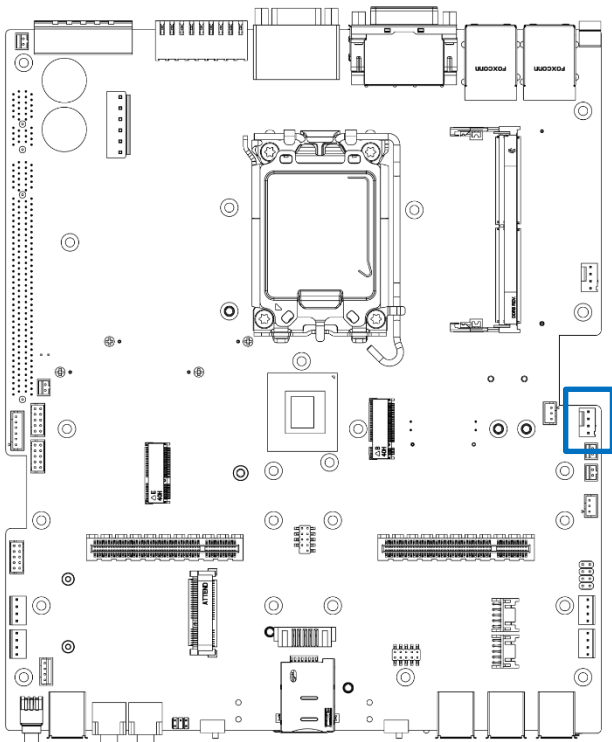

FAN_SIO

Switch	Definition
1	GND
2	+12V
3	Sense
4	Control

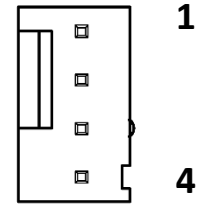
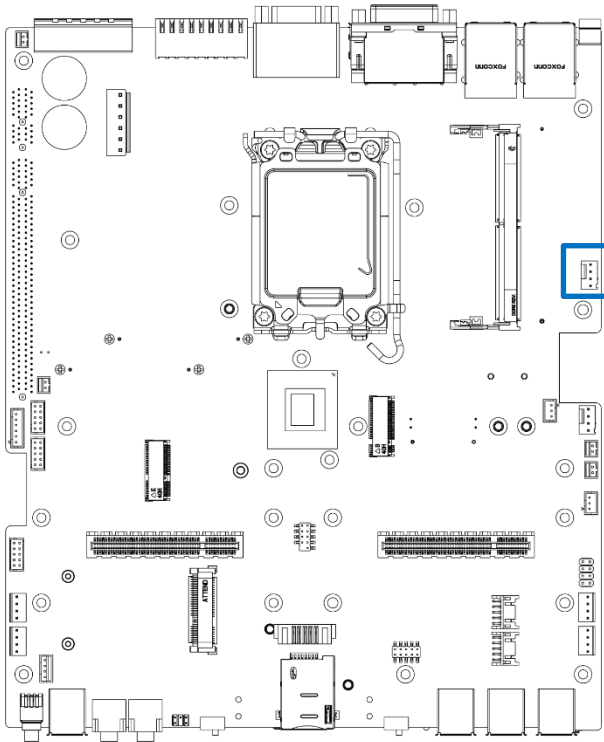

FAN_MCU

Pin	Signal
1	GND
2	+12V
3	Sense
4	Control

For FAN_MCU RT

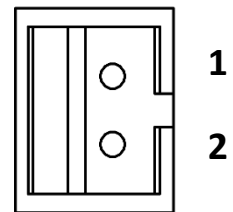
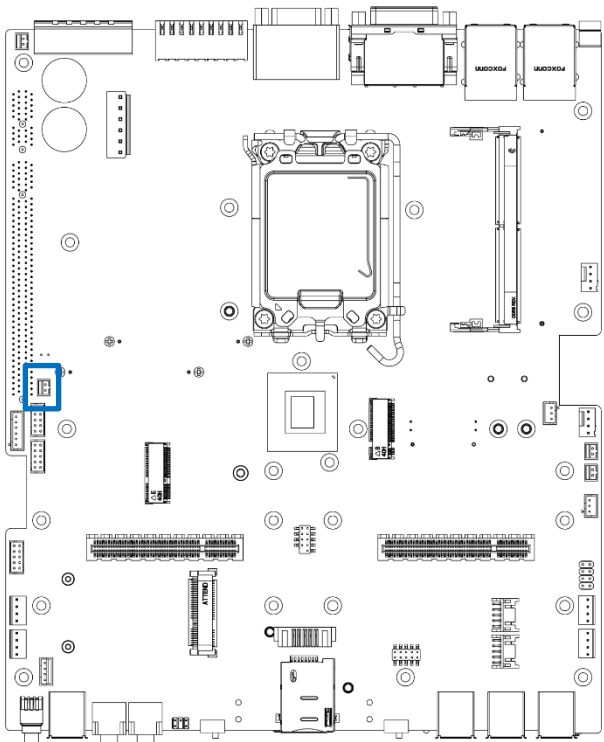

TEMP1

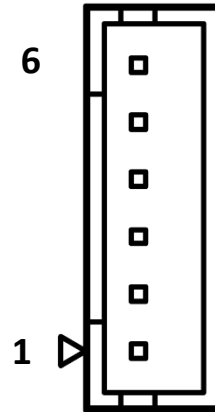
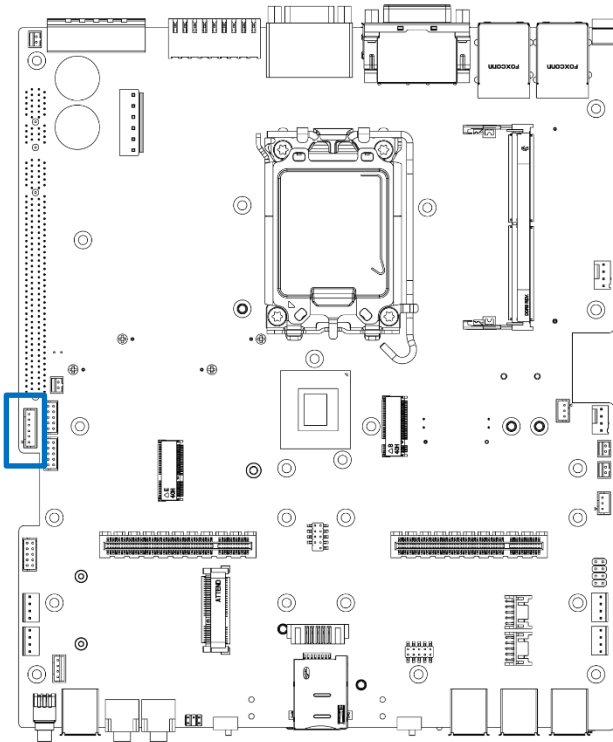

BH 1

Pin	Signal
1	+3.3V
2	PLTRST#
3	SLP S4
4	SLP S5
5	RSTBTN#
6	GND

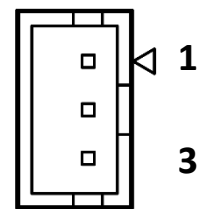
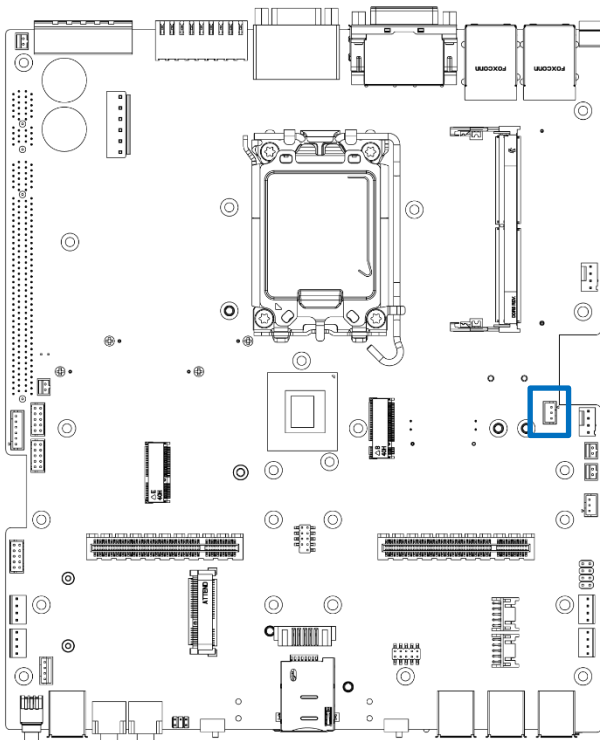

I2C

Switch	Definition
1	I2C_DATA
2	I2C_CLK
3	GND

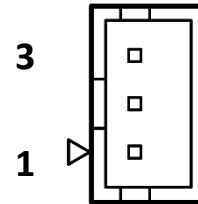
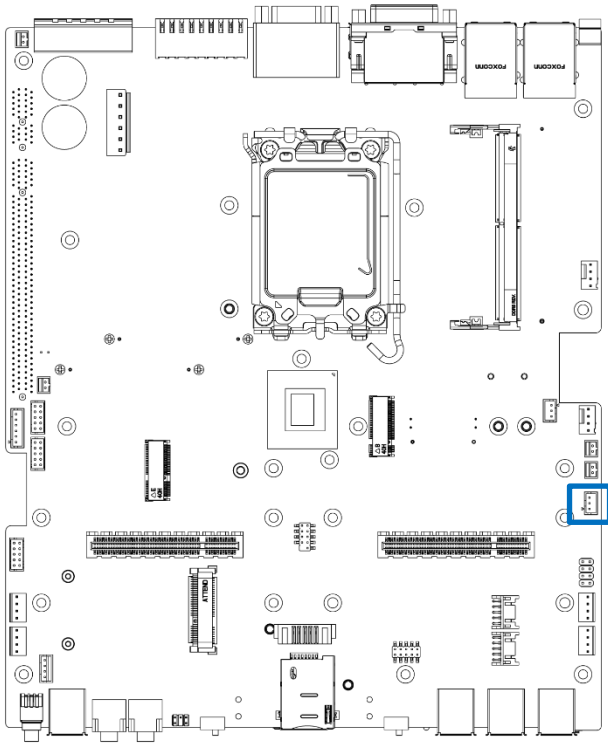

SMB

Pin	Signal
1	SMB_DATA
2	SMB_CLK
3	GND

2.3.23 LED Status

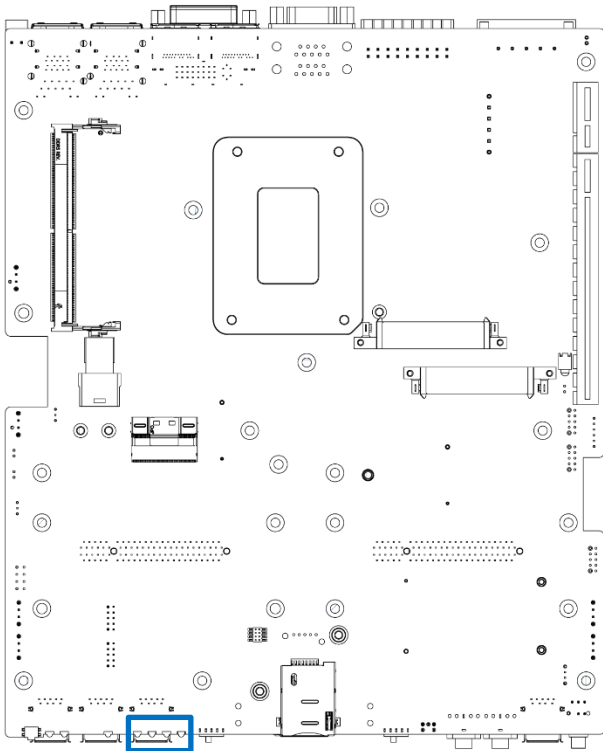

Act LED Status	Definition
Blinking Yellow	Data Activity
Off	No Activity



Link LED Status	CN3 Definition
Steady Orange	1 Gbps Network Link
Steady Green	100 Mbps Network Link
Off	10 Mbps Network Link

Link LED Status	CN4 Definition
Steady Orange	2.5 Gbps Network Link
Steady Green	1 Gbps Network Link
Off	100 Mbps Network Link

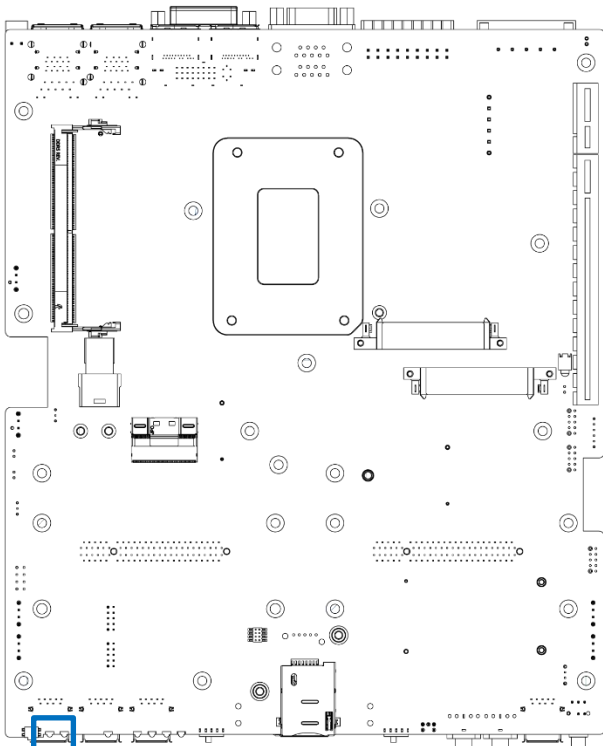

PWR_LED1: Power LED Status

Pin	Definition
1	POWER LED +
2	POWER LED -



HDD_LED1: HDD Access LED Status

Pin	Definition
1	HDD LED+
2	HDD LED-

LED Status

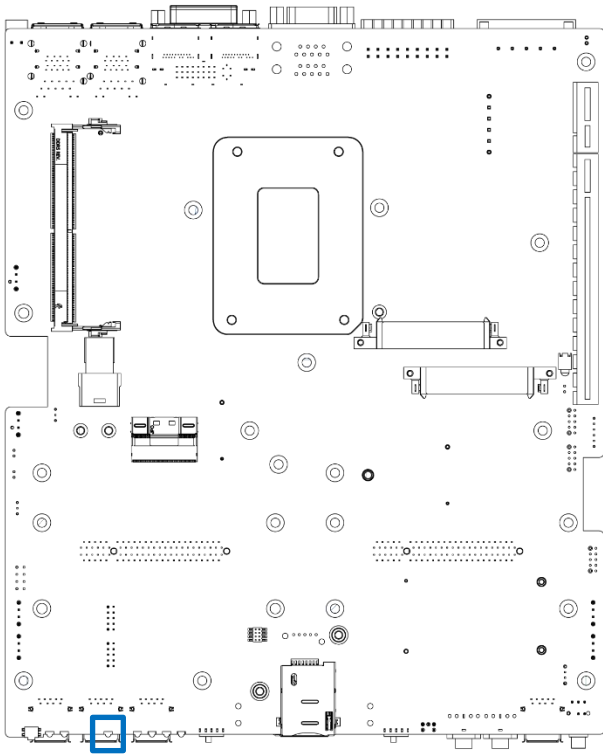

WDT_LED : WDTOUT LED Status

Pin	Definition
1	WDTOUT LED+
2	WDTOUT LED-

2.3.24 Top size SIM Card Socket

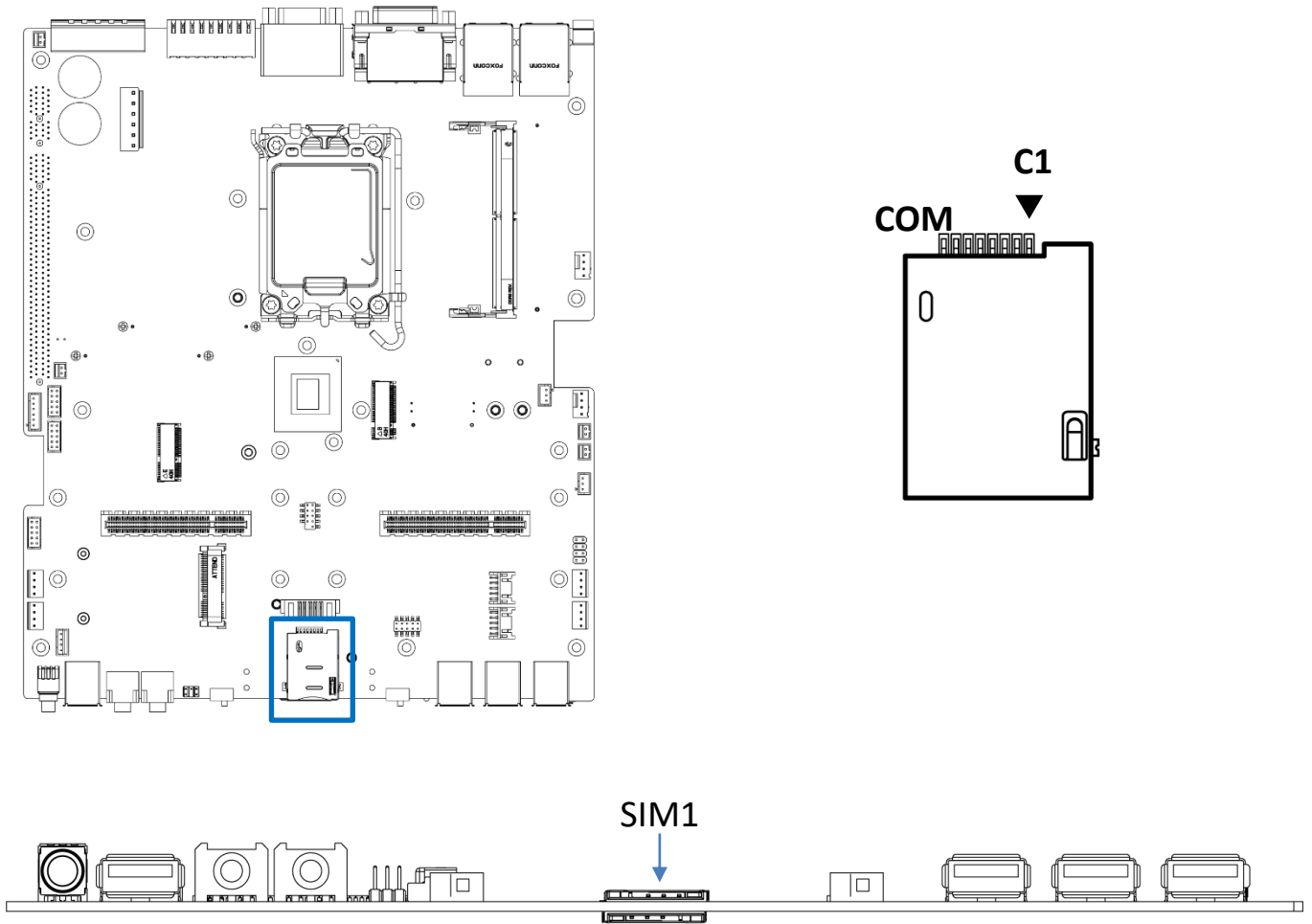

SIM1 (Top size for M.2 B Key)

Pin	Definition	Pin	Definition
C1	UIM_PWR	C6	UIM_VPP
C2	UIM_RESET	C7	UIM_DATA
C3	UIM_CLK	CD	NC
C5	GND	COM	GND

2.3.25 Bottom size SIM Card Socket

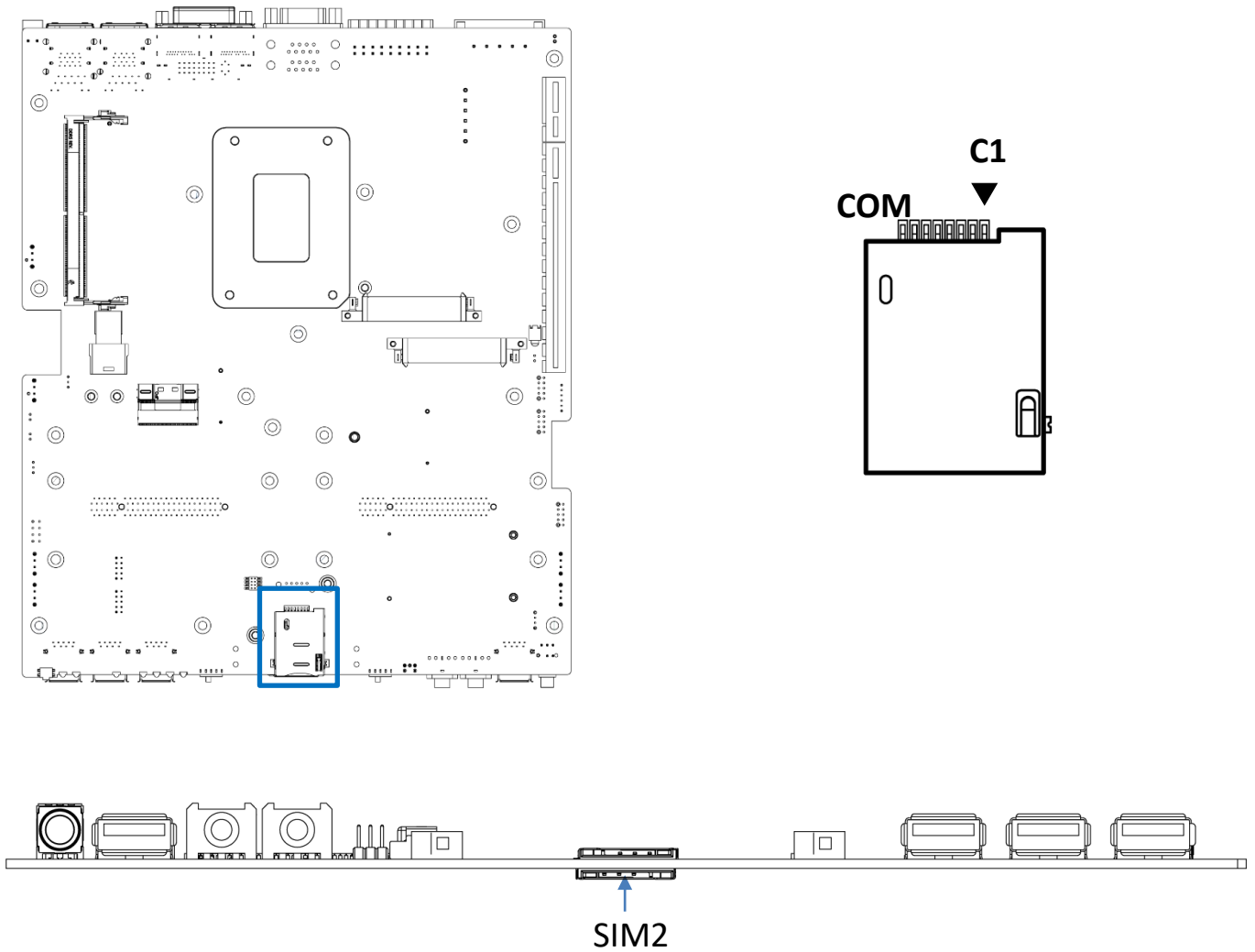

SIM2 (Bottom size for Mini PCIe)

Pin	Definition	Pin	Definition
C1	UIM_PWR	C6	UIM_VPP
C2	UIM_RESET	C7	UIM_DATA
C3	UIM_CLK	CD	NC
C5	GND	COM	GND

2.3.26 Mini PCI-Express / mSATA Socket

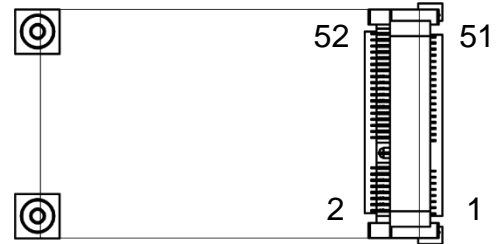
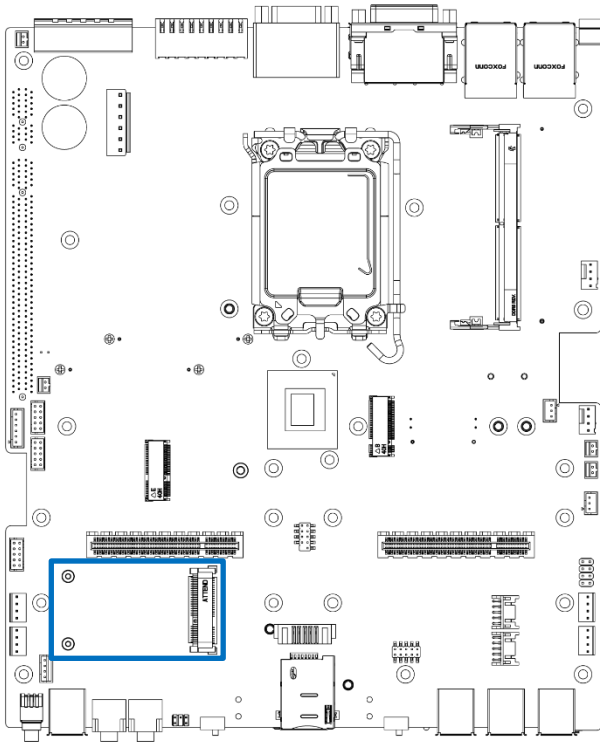

MINIPCIE

Pin	Definition	Pin	Definition
1	WAKE#	2	+3.3V
3	NC	4	GND
5	NC	6	+1.5V
7	CLKREQ#	8	UIM_PWR
9	GND	10	UIM_DATA
11	REFCLK-	12	UIM_CLK
13	REFCLK+	14	UIM_RST
15	GND	16	UIM_VPP
17	NC	18	GND
19	NC	20	NC
21	GND	22	RESET#
23	RxN	24	+3.3VAUX
25	RxP	26	GND
27	GND	28	+1.5V

Pin	Definition	Pin	Definition
29	GND	30	SMB_CLK
31	TxN	32	SMB_DATA
33	TxP	34	GND
35	GND	36	USB2_D-
37	GND	38	USB2_D+
39	+3.3V	40	GND
41	+3.3V	42	NC
43	GND	44	DEVSLP
45	NC	46	NC
47	NC	48	+1.5V
49	NC	50	GND
51	PCIE_MSATA_SEL	52	+3.3V

2.3.27 M.2 E Key Socket

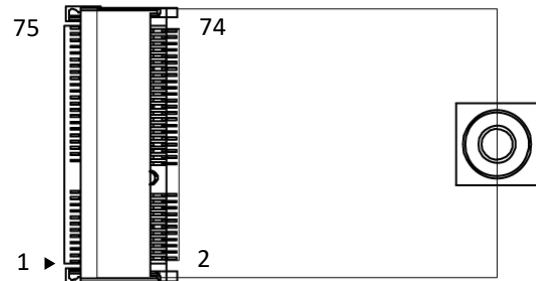
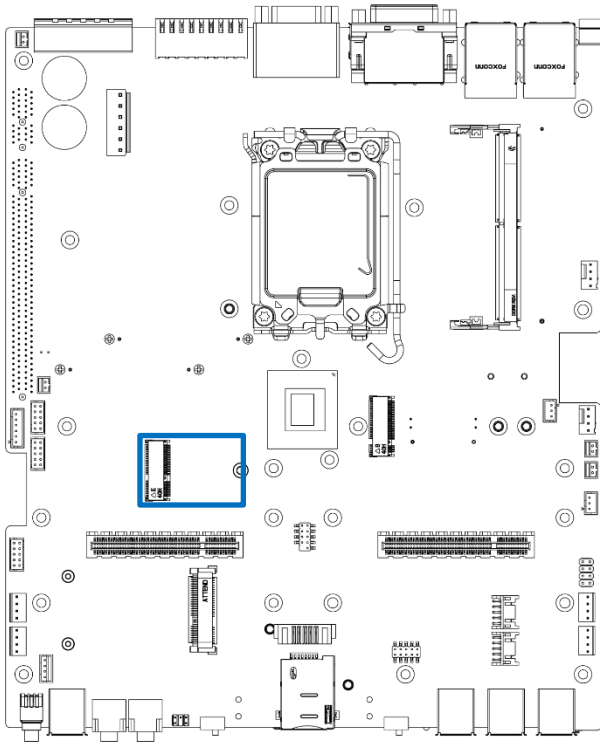

M2_KE

Pin	Definition	Pin	Definition
1	GND	2	+3.3VAUX
3	USB2_D+	4	+3.3VAUX
5	USB2_D-	6	NC
7	GND	8	I2S2_SCLK
9	CNV_WR_1_DN	10	CNV_RF_RESET#
11	CNV_WR_1_DP	12	I2S2_RXD
13	GND	14	MODEM_CLKREQ
15	CNV_WR_0_DN	16	NC
17	CNV_WR_0_DP	18	GND
19	GND	20	UART_WAKE_L
21	CNV_WR_CLK_DN	22	CNV_BRI_RSP
23	CNV_WR_CLK_DP	32	CNV_RGI_DT
33	GND	34	CNV_RGI_RSP
35	TxP0	36	CNV_BRI_DT

Pin	Definition	Pin	Definition
37	TxNO	38	CL_RST#
39	GND	40	CL_DATA
41	RxPO	42	CL_CLK
43	RxNO	44	CNV_PA_BLANKING
45	GND	46	CNV_MFUART2_TXD
47	REFCLK0+	48	CNV_MFUART2_RXD
49	REFCLK0-	50	SUSCLK
51	GND	52	PERST0#
53	NC	54	M2_KEY-E_BT_DIS2#
55	WAKE0#	56	M2_KEY-E_WIFI_DIS1#
57	GND	58	SMBDATAS_DUAL
59	CNV_WT_1_DN	60	SMBCLKS_DUAL
61	CNV_WT_1_DP	62	SMBALERT#
63	GND	64	Pull Low
65	CNV_WT_0_DN	66	PERST1#
67	CNV_WT_0_DP	68	NC
69	GND	70	WAKE1#
71	CNV_WT_CLK_DN	72	+3.3VAUX
73	CNV_WT_CLK_DP	74	+3.3VAUX
75	GND		

2.3.28 M.2 B Key Socket

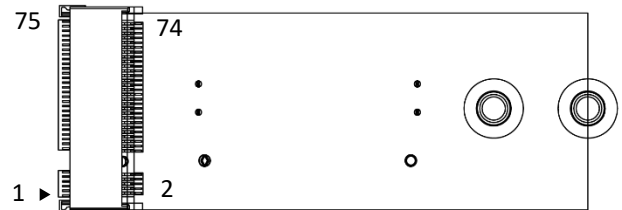
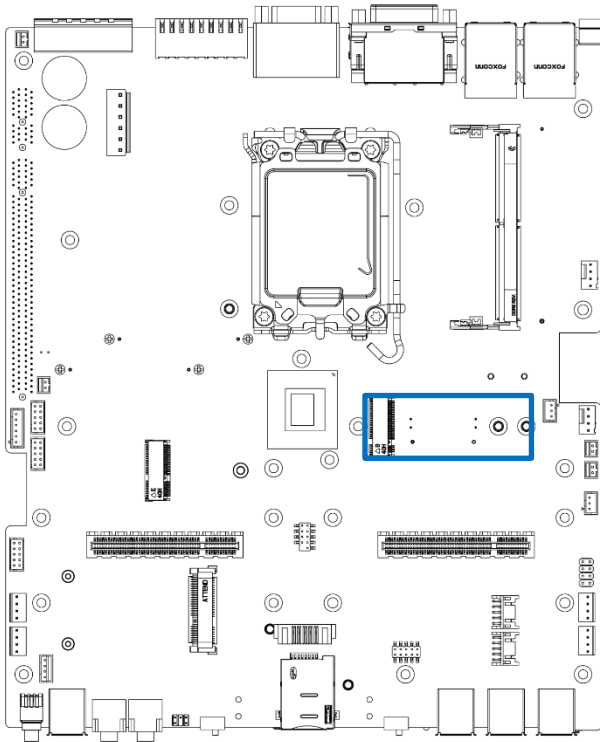

M2_KB

Pin	Definition	Pin	Definition
1	CONFIG_3	2	+3.3V
3	GND	4	+3.3V
5	GND	6	FULL_CARD_POWER_OFF#
7	USB_D+	8	W_DISABLE1#
9	USB_D-	10	WWAN_LED#
11	GND	20	NC
21	CONFIG_0	22	NC
23	GPIO_11(0/1.8V)	24	NC
25	DPR	26	NC
27	GND	28	P_UIM_VPP
29	PERn1/USB3.0-Rx-	30	USIM1_RST
31	PERp1/USB3.0-Rx+	32	USIM1_CLK
33	GND	34	USIM1_DATA
35	PETn1/USB3.0-Tx-	36	USIM1_VDD

Pin	Definition	Pin	Definition
37	PETp1/USB3.0-Tx+	38	NC
39	GND	40	NC
41	PERn0/SATA-B+	42	NC
43	PERp0/SATA-B-	44	NC
45	GND	46	NC
47	PETn0/SATA-A-	48	NC
49	PETp0/SATA-A+	50	PCIE_RST_N
51	GND	52	PCIE_CLKREQ_N
53	PCIE_REFCLK_M	54	PCIE_WAKE_N
55	PCIE_REFCLK_P	56	NC
57	GND	58	NC
59	NC	60	NC
61	NC	62	NC
63	NC	64	NC
65	NC	66	USIM1_DET
67	NC	68	SUSCLK(32kHz)
69	CONFIG_1	70	+3.3VAUX
71	GND	72	+3.3VAUX
73	GND	74	+3.3VAUX
75	CONFIG_2		

2.3.29 PCI-Express x1 Slot

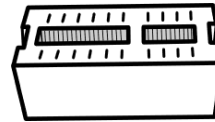
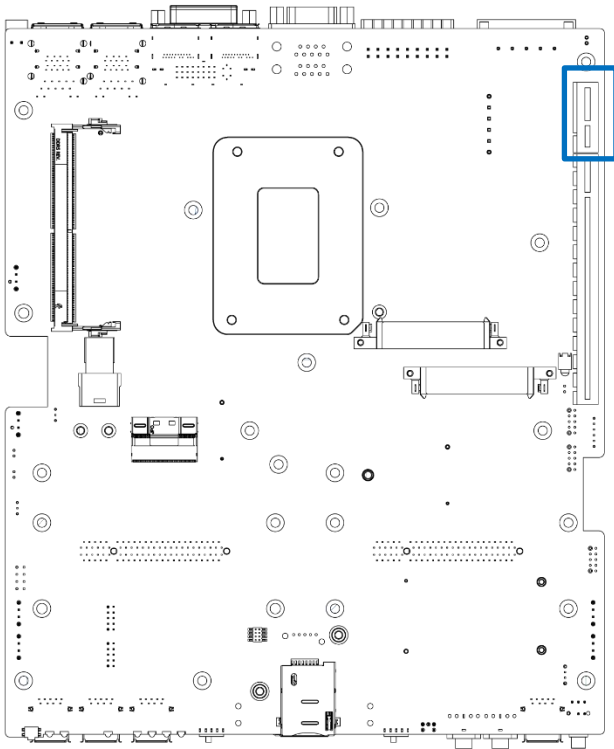

PCIE 2

Pin	Definition	Pin	Definition
B1	+12V	A1	FAN_P4
B2	+12V	A2	+12V
B3	+12V	A3	+12V
B4	GND	A4	GND
B5	SMB_CLK	A5	NC
B6	SMB_DATA	A6	NC
B7	GND	A7	NC
B8	+3.3V	A8	NC
B9	NC	A9	+3.3V
B10	+3.3VAUX	A10	+3.3V
B11	WAKE#	A11	RESET#
B12	FAN_P3	A12	GND
B13	GND	A13	REFCLK+
B14	TxP0	A14	REFCLK-
B15	TxN0	A15	GND
B16	GND	A16	RxP0
B17	FAN_PER	A17	RxN0
B18	GND	A18	GND

2.3.30 PCI-Express x16 Slot

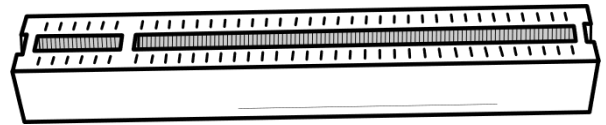
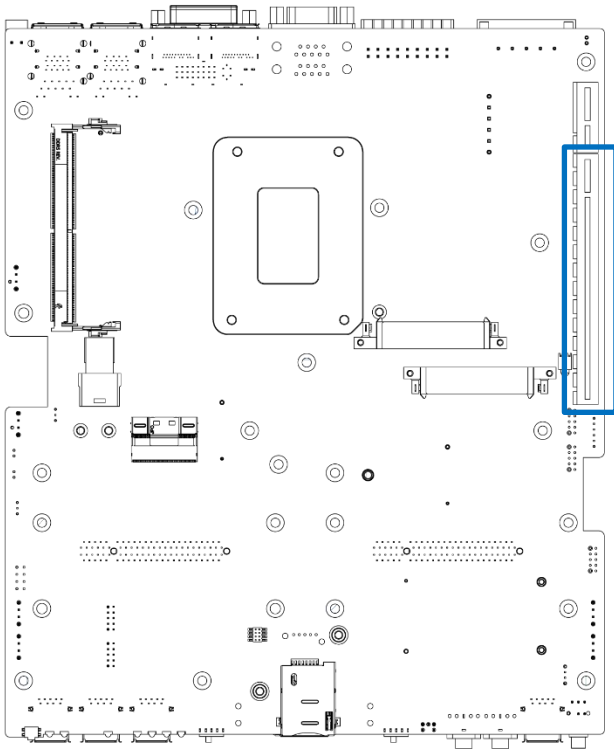

PCIE 1

Pin	Definition	Pin	Definition
B1	+12V	A1	NC
B2	+12V	A2	+12V
B3	+12V	A3	+12V
B4	GND	A4	GND
B5	SMB_CLK	A5	NC
B6	SMB_DATA	A6	NC
B7	GND	A7	NC
B8	+3.3V	A8	NC
B9	NC	A9	+3.3V
B10	+3.3VAUX	A10	+3.3V
B11	WAKE#	A11	RESET#
B12	NC	A12	GND
B13	GND	A13	REFCLK+

Pin	Definition	Pin	Definition
B14	TxP0	A14	REFCLK-
B15	TxN0	A15	GND
B16	GND	A16	RxP0
B17	NC	A17	RxN0
B18	GND	A18	GND
B19	TxP1	A19	NC
B20	TxN1	A20	GND
B21	GND	A21	RxP1
B22	GND	A22	RxN1
B23	TxP2	A23	GND
B24	TxN2	A24	GND
B25	GND	A25	RxP2
B26	GND	A26	RxN2
B27	TxP3	A27	GND
B28	TxN3	A28	GND
B29	GND	A29	RxP3
B30	NC	A30	RxN3
B31	S3	A31	GND
B32	GND	A32	CFG_5
B33	TxP4	A33	CFG_6
B34	TxN4	A34	GND
B35	GND	A35	RxP4
B36	GND	A36	RxN4
B37	TxP5	A37	GND
B38	TxN5	A38	GND

Pin	Definition	Pin	Definition
B39	GND	A39	RxP5
B40	GND	A40	RxN5
B41	TxP6	A41	GND
B42	TxN6	A42	GND
B43	GND	A43	RxP6
B44	GND	A44	RxN6
B45	TxP7	A45	GND
B46	TxN7	A46	GND
B47	GND	A47	RxP7
B48	NC	A48	RxN7
B49	GND	A49	GND
B50	TxP8	A50	NC
B51	TxN8	A51	GND
B52	GND	A52	RxP8
B53	GND	A53	RxN8
B54	TxP9	A54	GND
B55	TxN9	A55	GND
B56	GND	A56	RxP9
B57	GND	A57	RxN9
B58	TxP10	A58	GND
B59	TxN10	A59	GND
B60	GND	A60	RxP10
B61	GND	A61	RxN10
B62	TxP11	A62	GND
B63	TxN11	A63	GND

Pin	Definition	Pin	Definition
B64	GND	A64	RxP11
B65	GND	A65	RxN11
B66	TxP12	A66	GND
B67	TxN12	A67	GND
B68	GND	A68	RxP12
B69	GND	A69	RxN12
B70	TxP13	A70	GND
B71	TxN13	A71	GND
B72	GND	A72	RxP13
B73	GND	A73	RxN13
B74	TxP14	A74	GND
B75	TxN14	A75	GND
B76	GND	A76	RxP14
B77	GND	A77	RxN14
B78	TxP15	A78	GND
B79	TxN15	A79	GND
B80	GND	A80	RxP15
B81	NC	A81	RxN15
B82	NC	A82	GND

2.3.31 PCI-Express x8 Slot

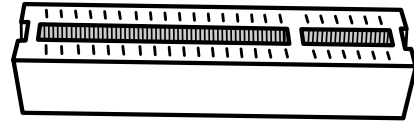
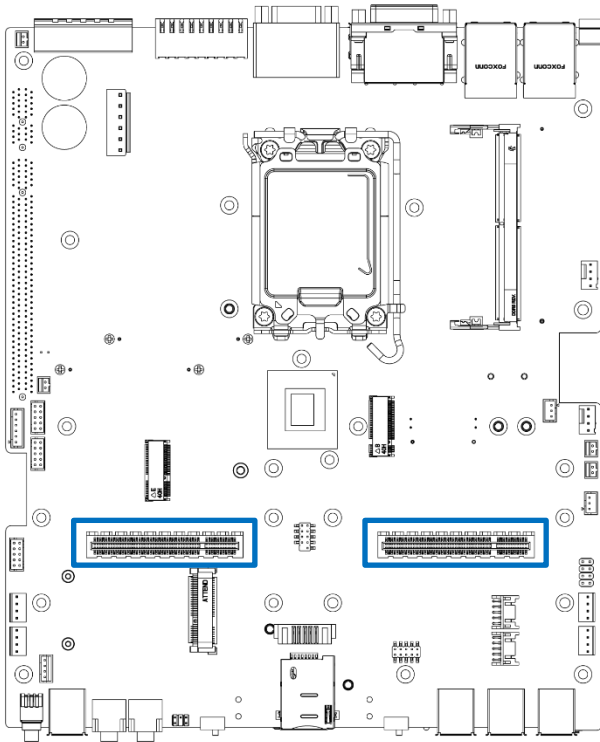

PCIE (LAN_L , LAN_R)

Pin	Definition	Pin	Definition
B1	+12V	A1	NC
B2	+12V	A2	+12V
B3	+12V	A3	+12V
B4	GND	A4	GND
B5	SMB_CLK	A5	NC
B6	SMB_DATA	A6	NC
B7	GND	A7	NC
B8	+3.3V	A8	NC
B9	NC	A9	+3.3V
B10	+3.3VAUX	A10	+3.3V
B11	WAKE#	A11	RESET#
B12	NC	A12	GND
B13	GND	A13	REFCLK+
B14	TxP0	A14	REFCLK-
B15	TxN0	A15	GND

Pin	Definition	Pin	Definition
B16	GND	A16	RxP0
B17	NC	A17	RxN0
B18	GND	A18	GND
B19	TxP1	A19	NC
B20	TxN1	A20	GND
B21	GND	A21	RxP1
B22	GND	A22	RxN1
B23	TxP2	A23	GND
B24	TxN2	A24	GND
B25	GND	A25	RxP2
B26	GND	A26	RxN2
B27	TxP3	A27	GND
B28	TxN3	A28	GND
B29	GND	A29	RxP3
B30	NC	A30	RxN3
B31	NC	A31	GND
B32	GND	A32	NC
B33	9_48VSB_IN	A33	9_48VSB_IN
B34	9_48VSB_IN	A34	9_48VSB_IN
B35	9_48VSB_IN	A35	9_48VSB_IN
B36	9_48VSB_IN	A36	9_48VSB_IN
B37	9_48VSB_IN	A37	9_48VSB_IN
B38	9_48VSB_IN	A38	9_48VSB_IN
B39	9_48VSB_IN	A39	9_48VSB_IN
B40	9_48VSB_IN	A40	9_48VSB_IN
B41	9_48VSB_IN	A41	9_48VSB_IN
B42	9_48VSB_IN	A42	9_48VSB_IN
B43	+3.3VAUX	A43	+5V
B44	+3.3VAUX	A44	+5V
B45	+3.3VAUX	A45	+1.5V
B46	+3.3VAUX	A46	+1.5V
B47	+1.0VAUX	A47	+1.0VAUX
B48	+1.0VAUX	A48	+1.0VAUX
B49	NC	A49	NC

2.3.32 SATA with Power Connector

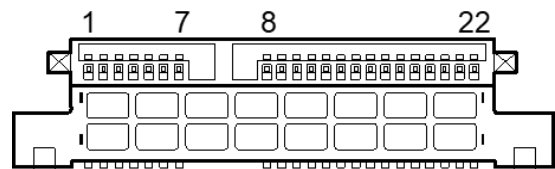
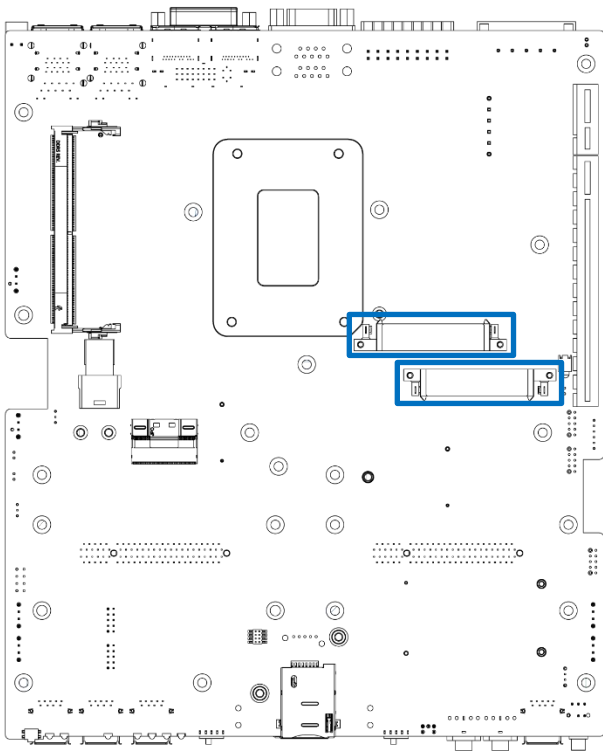

SATA 1, SATA 2

Pin	Definition
1	GND
2	TxP
3	TxN
4	GND
5	RxN
6	RxP
7	GND
8	NC
9	NC
10	DEVS LP
11	GND

Pin	Definition
12	GND
13	GND
14	+5V
15	+5V
16	+5V
17	GND
18	GND
19	GND
20	+12V
21	+12V
22	+12V

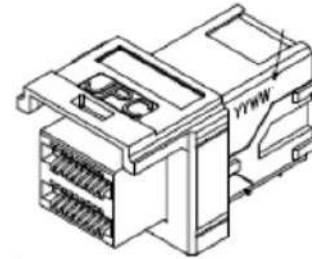
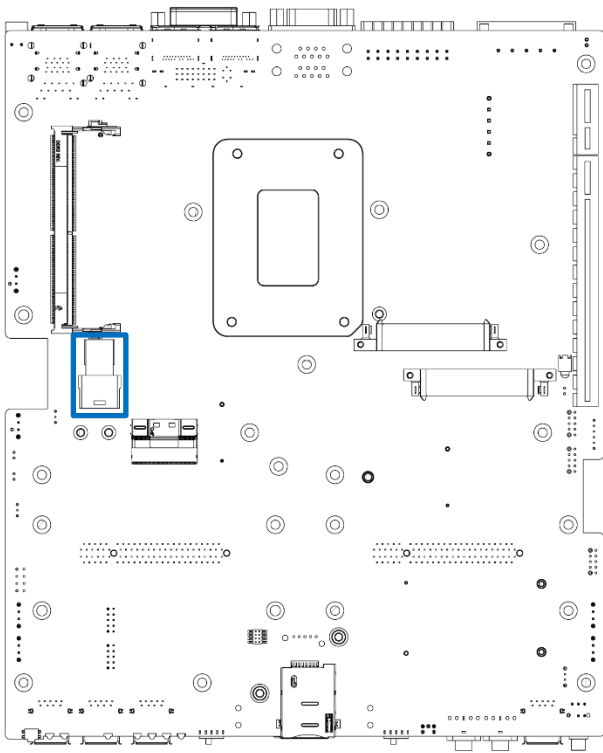

SATA 3

Pin	Definition	Pin	Definition	Pin	Definition	Pin	Definition
A1	NC	B1	NC	C1	NC	D1	NC
A2	NC	B2	NC	C2	NC	D2	NC
A3	GND	B3	GND	C3	GND	D3	GND
A4	RxP1	B4	RxP0	C4	TxP1	D4	TxP0
A5	RxN1	B5	RxN0	C5	TxN1	D5	TxN0
A6	GND	B6	GND	C6	GND	D6	GND
A7	RxP3	B7	RxP2	C7	TxP3	D7	TxP2
A8	RxN3	B8	RxN2	C8	TxN3	D8	TxN2
A9	GND	B9	GND	C9	GND	D9	GND

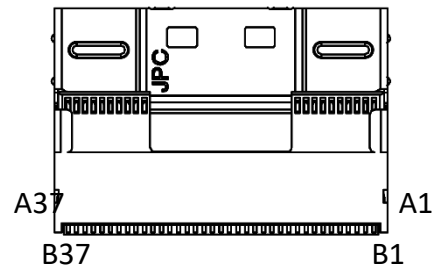
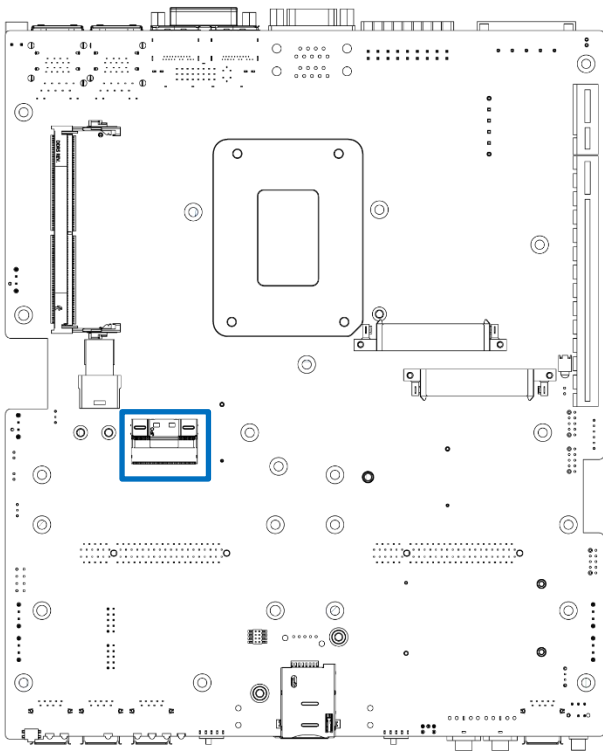

SL 1 Slimline PCIe x8

Pin	Definition	Pin	Definition
B1	GND	A1	GND
B2	TxP0	A2	RxP0
B3	TxN0	A3	RxN0
B4	GND	A4	GND
B5	TxP1	A5	RxP1
B6	TxN1	A6	RxN1
B7	GND	A7	GND
B8	RST#1	A8	CLKP1
B9	RST#2	A9	CLKN1
B10	GND	A10	GND
B11	RST#3	A11	CLKP2
B12	RST#4	A12	CLKN2
B13	GND	A13	GND
B14	TxP2	A14	RxP2
B15	TxN2	A15	RxN2

Pin	Definition	Pin	Definition
B16	GND	A16	GND
B17	TxP3	A17	RxP3
B18	TxN3	A18	RxN3
B19	GND	A19	GND
B20	TxP4	A20	RxP4
B21	TxN4	A21	RxN4
B22	GND	A22	GND
B23	TxP5	A23	RxP5
B24	TxN5	A24	RxN5
B25	GND	A25	GND
B26	PRSNT#1	A26	CLKP3
B27	PRSNT#2	A27	CLKN3
B28	GND	A28	GND
B29	RST#3	A29	CLKP4
B30	PRSNT#4	A30	CLKN4
B31	GND	A31	GND
B32	TxP6	A32	RxP6
B33	TxN6	A33	RxN6
B34	GND	A34	GND
B35	TxP7	A35	RxP7
B36	TxN7	A36	RxN7
B37	GND	A37	GND

Chapter 3

System Setup

3.1 Set torque force to 3.5 kgf-cm to execute all the screwing and unscrewing.

3.2 Removing heat sink cover

**WARNING**

In order to prevent electric shock or system damage, you must turn off the power and disconnect the unit from the power source before removing the chassis cover.



1. Unscrew four screws (M3x5L) on each of two sides located on the top

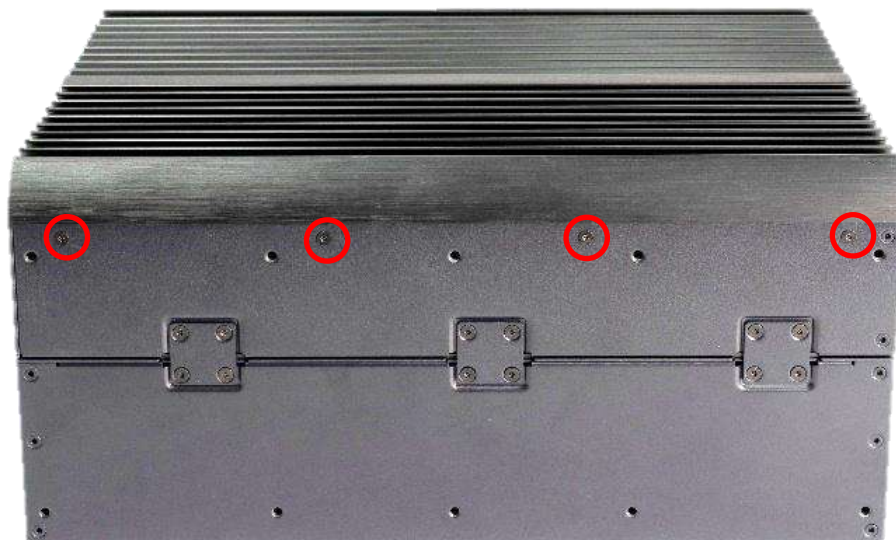

- Now you can remove the heat sink cover.



- Internal structure of the machine



4. Unscrew the six screws (M3x5L) highlighted below.

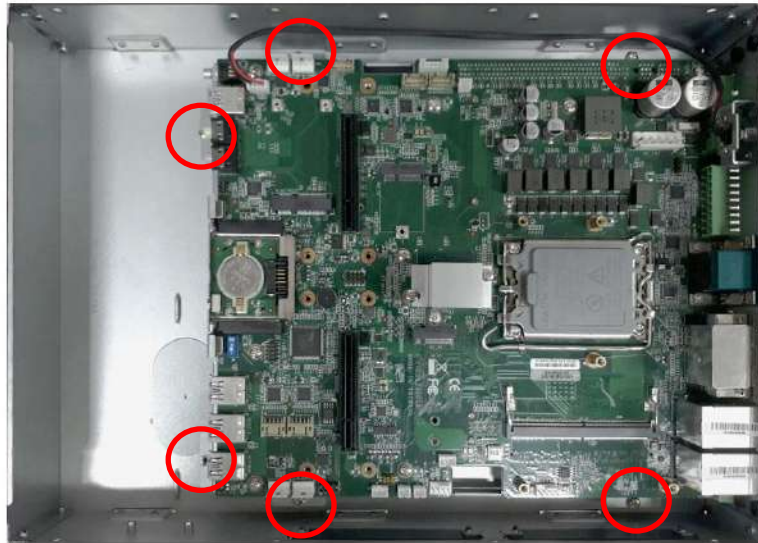

5. Unscrew four screws (M3x5L) on the front side.



6. Hold the body of the computer and lift it vertically away.



3.3 Install CPU

1. Remove the CPU protective cover.

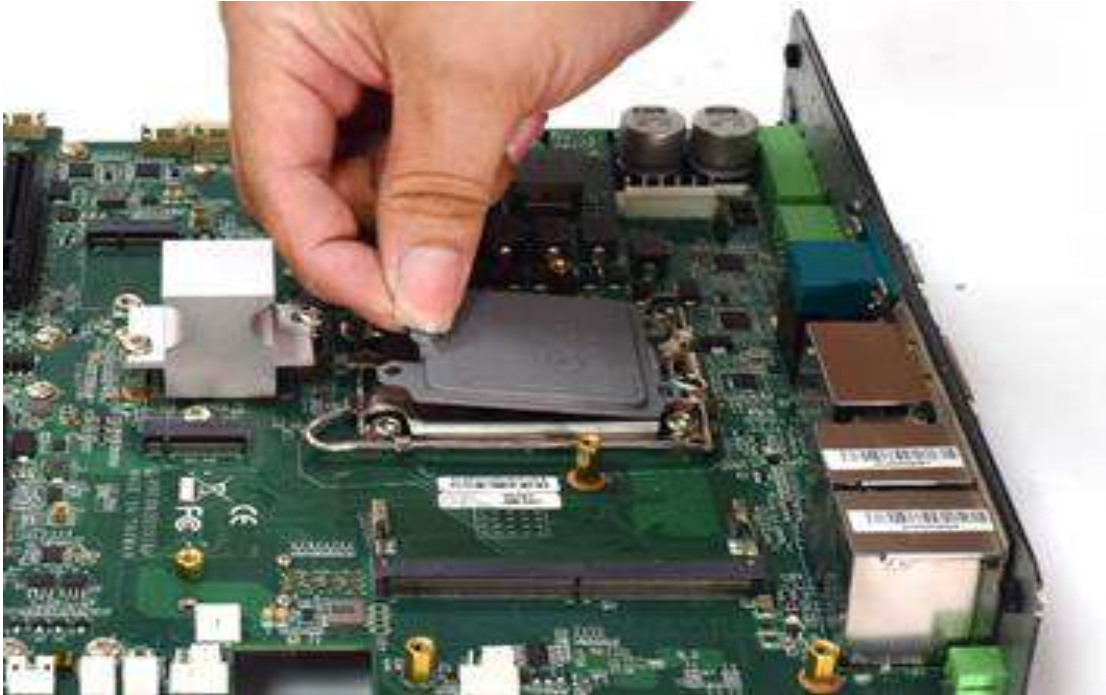

2. Press down on the lever in order to release the socket, as shown below.



3. Hold the CPU by its edges, and carefully align the notches on the CPU with the corresponding notches on the socket, as highlighted by the red circles in the pictures below. Gently set the CPU into the socket without any force.

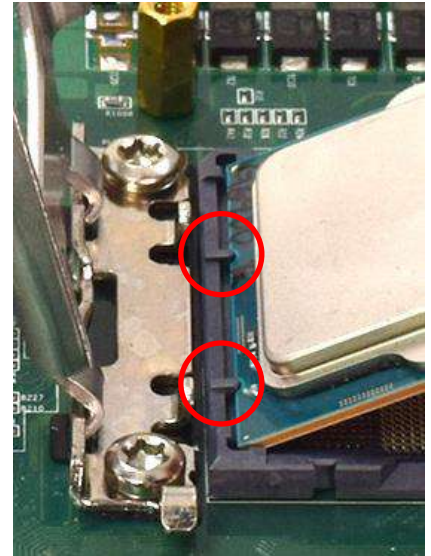
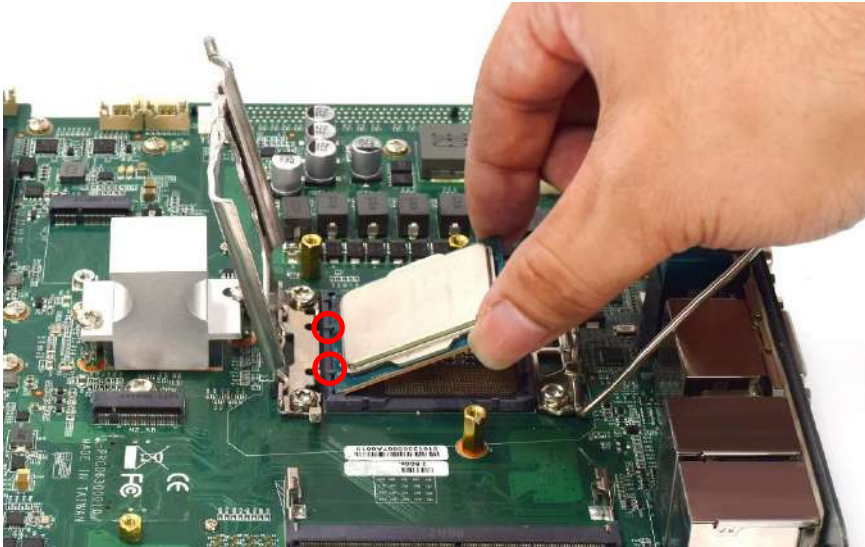

4. Once the CPU has been placed, press the lever again to secure the socket. The final setup should resemble the picture provided below.

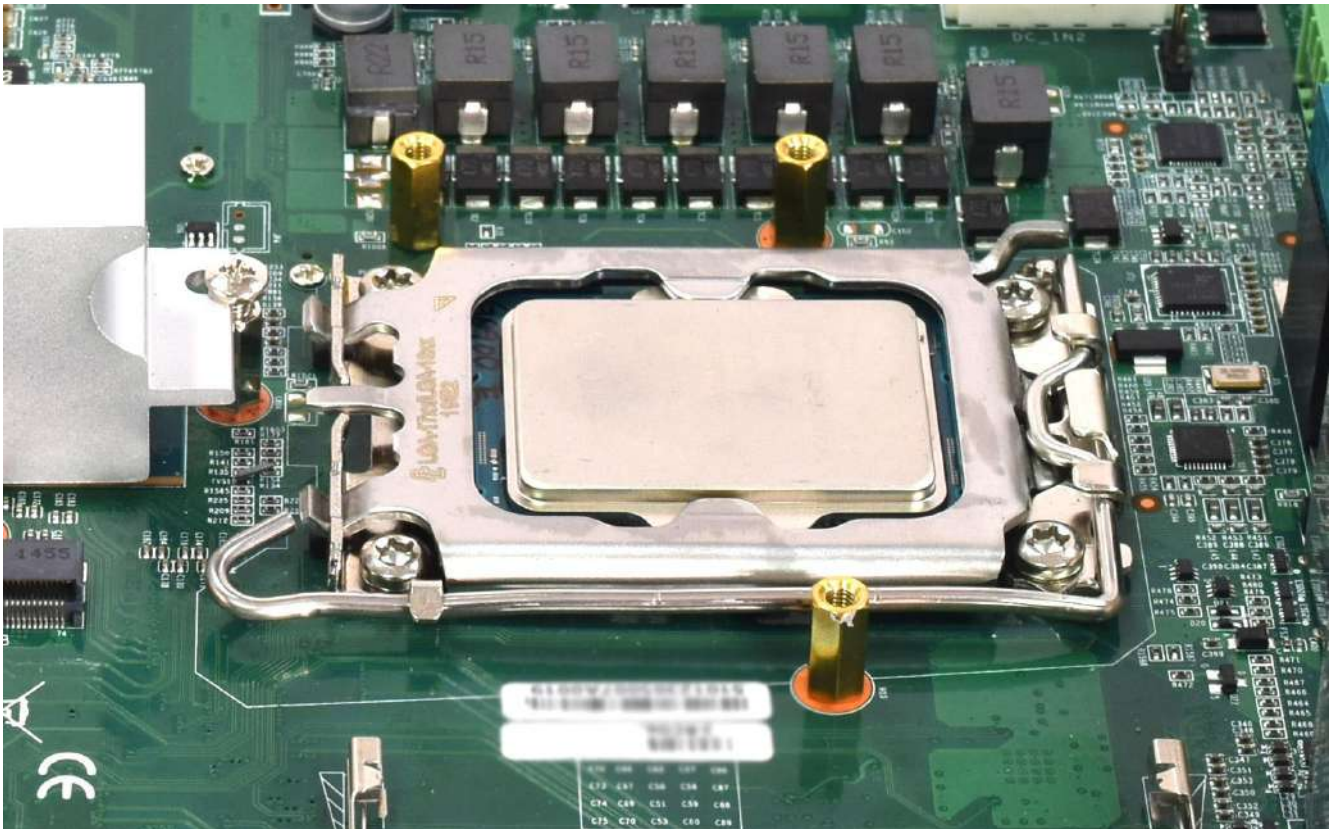

3.4 Install the first DRAM externally

1. VCO-6000-RPL board has one SODIMM slot on both the front and back sides. The picture below shows the SODIMM slot on the back of the motherboard, and you should prioritize inserting the first DRAM.



2. Insert memory module at a 45-degree angle.



3. Push the memory module down against the board until you hear a “click” sound. Make sure the memory module is secure.

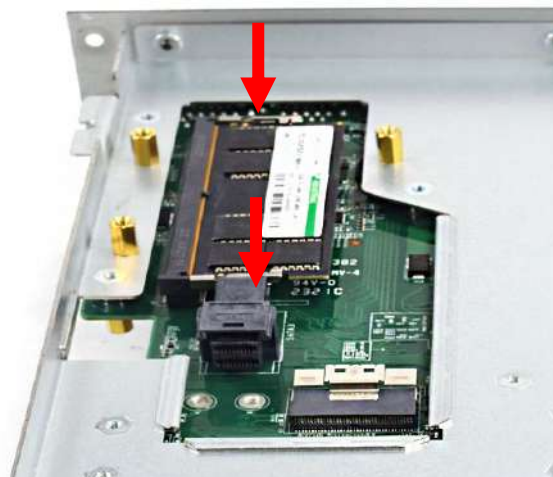

4. Paste the thermal pad on the heat block .



5. Apply the heat sink with a thermal pad to the memory and secure the heat sink using three screws (M3x5L). The screws can pass through the top holes and fasten onto the copper pillars.

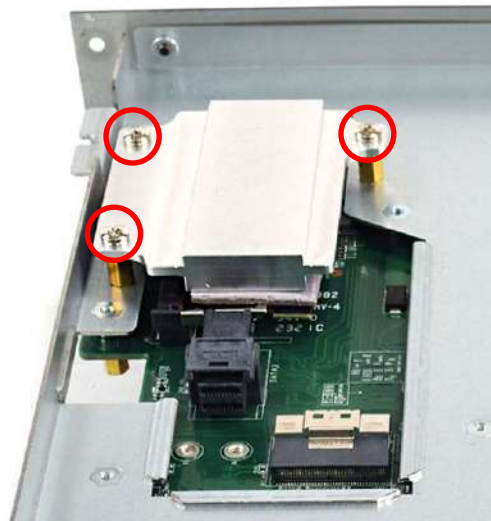

6. Paste the thermal pad onto the installed DRAM heat block.



3.5 Install the second DRAM externally

1. The picture below shows the SODIMM slot on the front of the motherboard. Insert the second DRAM in order.



2. Insert the memory module at a 45-degree angle.



3. Gently push the memory module down against the board until you hear a “click” sound. Make sure the memory module is secured.

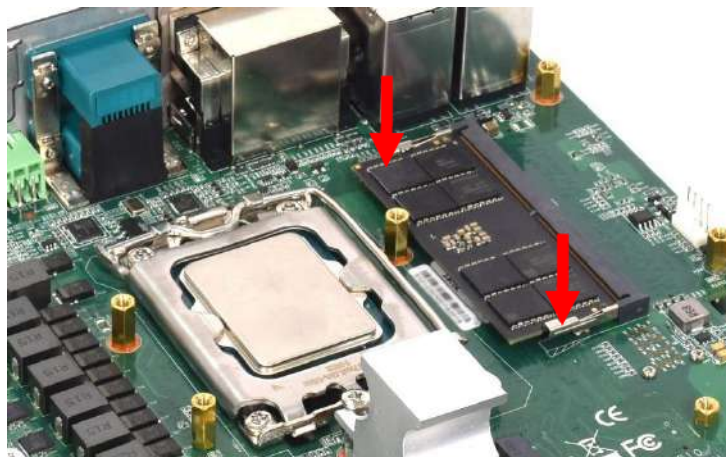

3.6 Install CPU & SODIMM heat block

1. Paste the thermal pad on the CPU.

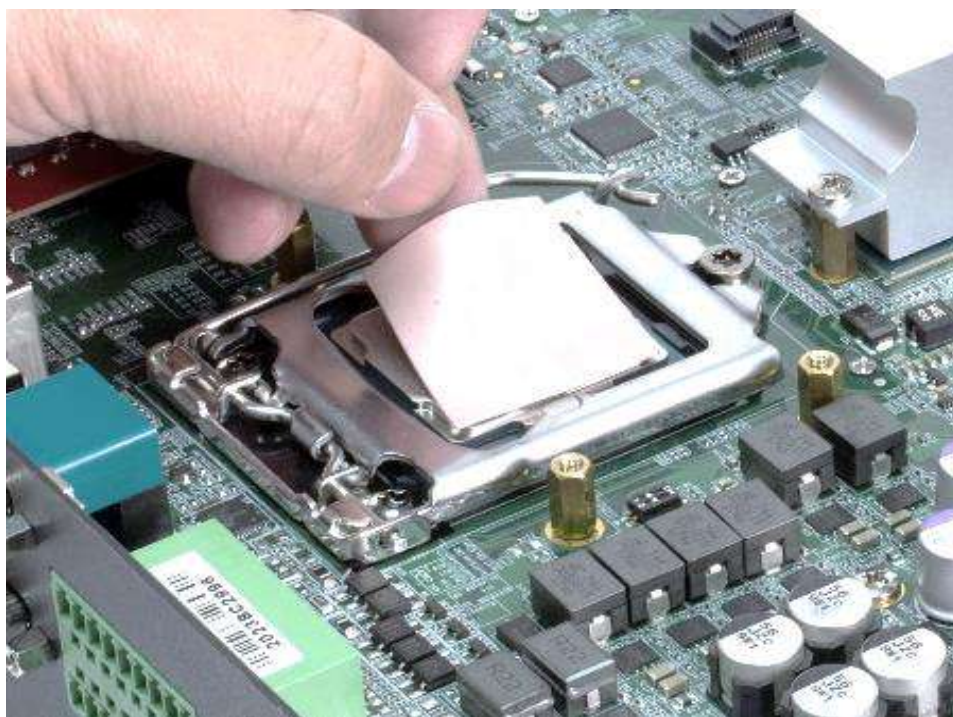

2. Place the designated heat block onto the CPU with thermal pad.

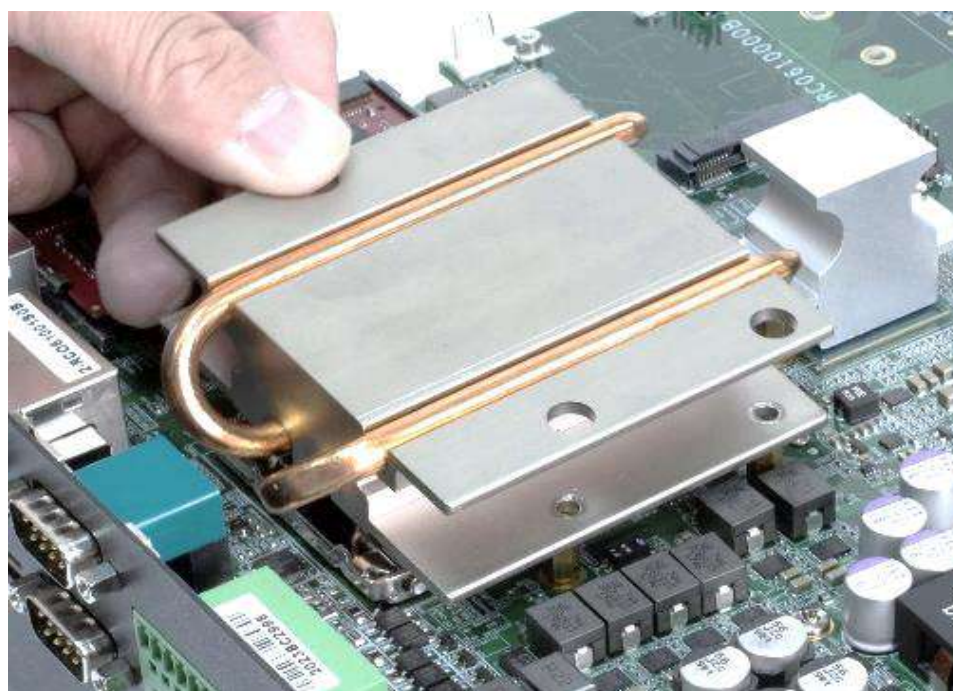

- Secure the heat block using two screws (M3x8L). The screwdriver can go through the holes on top to fasten the screws below.

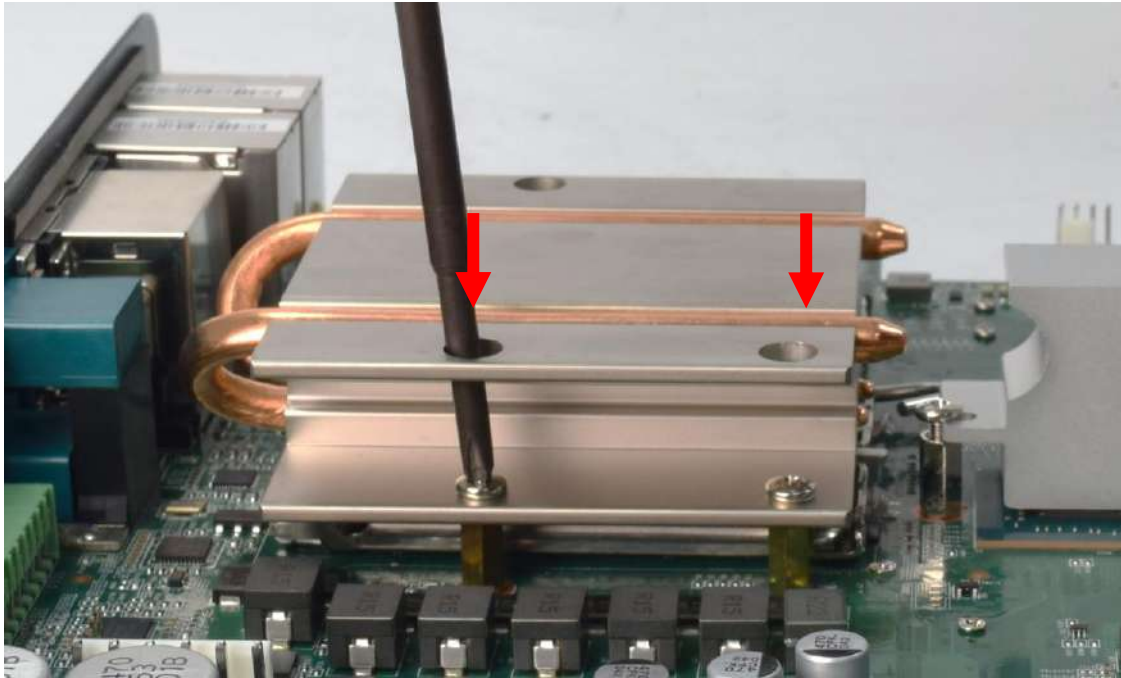

- Paste the thermal pad on the DRAM.



5. Place the designated heat block onto the DRAM with thermal pad.

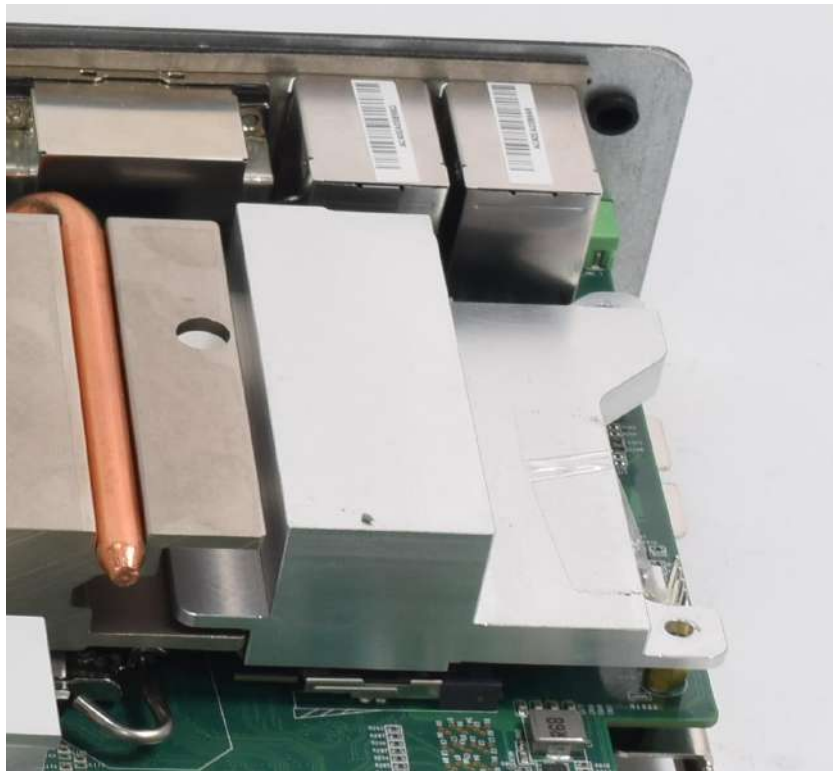

6. Secure the heat block with one screw (M3x8L). The screwdriver can go through the hole on the top to fasten the screw below.

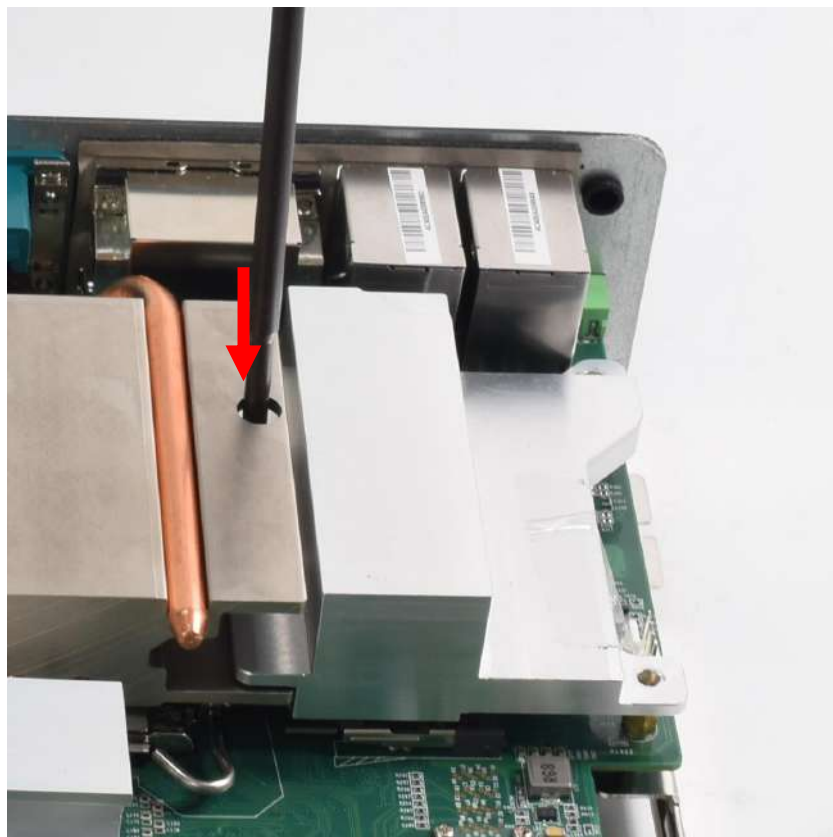

- Secure the heat block with two screws (M3x5L). The screwdriver can go through the holes on top to order to fasten the screws below.

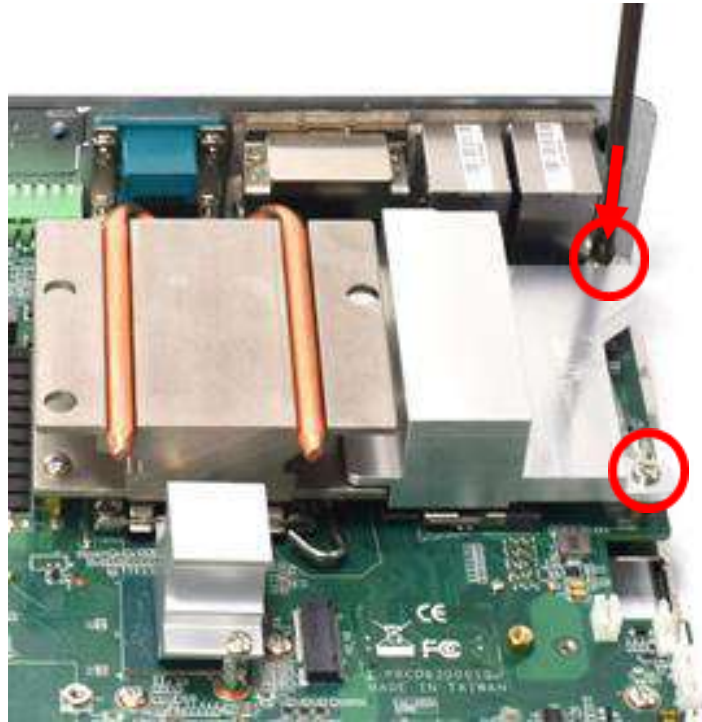

- Paste the thermal pad onto the installed DRAM heat block.



9. Paste the thermal pad onto the installed CPU heat block.



10. Paste the thermal pad onto the PCH heat block.

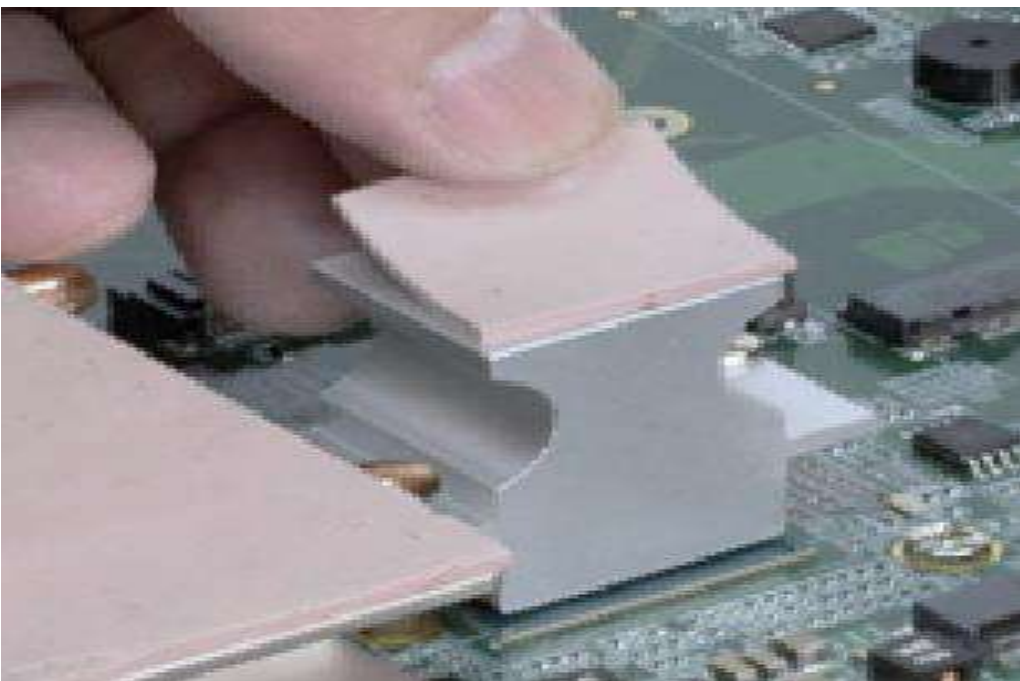

3.7 Install HDD/SSD on the internal SATA bay

1. One internal SATA HDD/SSD bays are available for VCO-6000-RPL series.



2. Unscrew the four screws (M3x5L) to remove the internal SATA HDD/SSD bay.

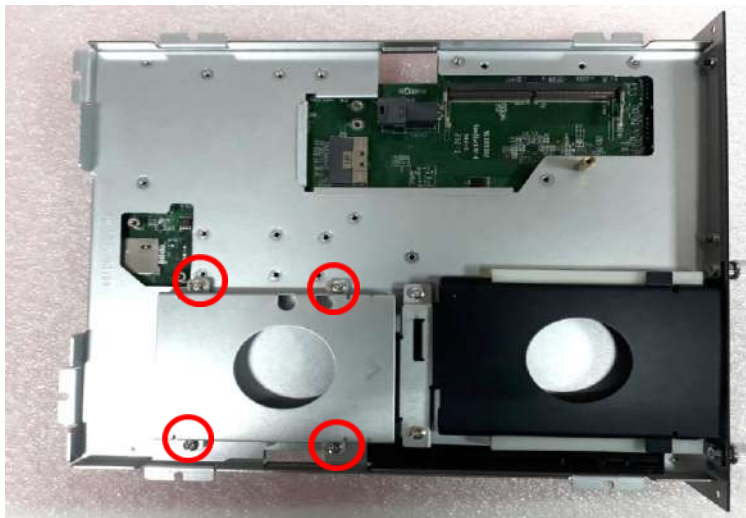

3. Lock the 2.5" HDD with HDD/SSD bracket using four screws (M3x4L).

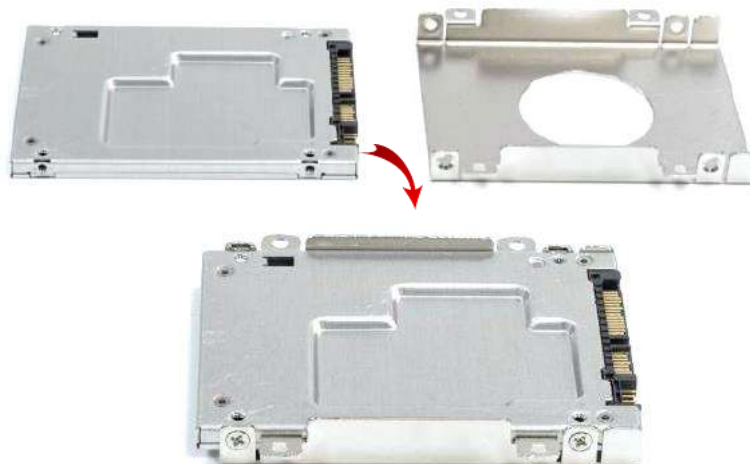

4. Install the HDD/SSD bracket following the direction below.



5. Fasten the 4 screws to lock the internal HDD/SSD bracket.

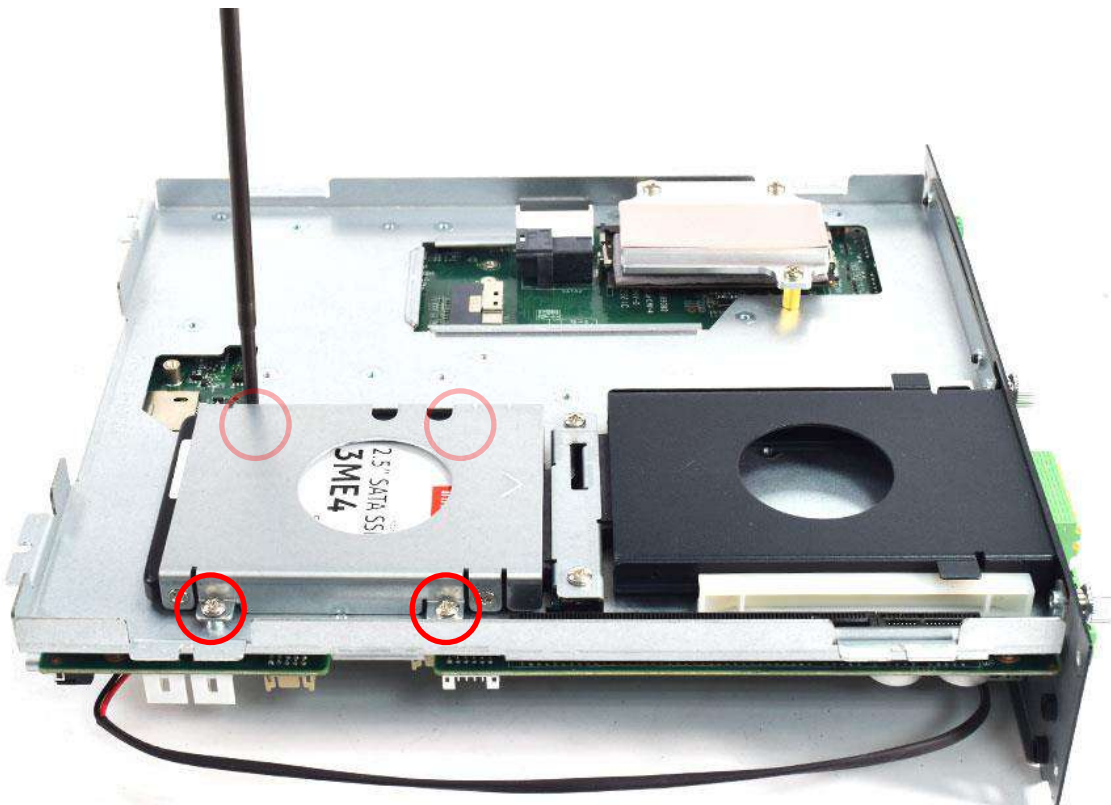

3.8 Install HDD on removable SATA HDD bay

One removable SATA HDD bay is available for the VCO-6000-RPL Series.

1. Unscrew the two sun screws circled below to take out the removable SATA HDD bay.

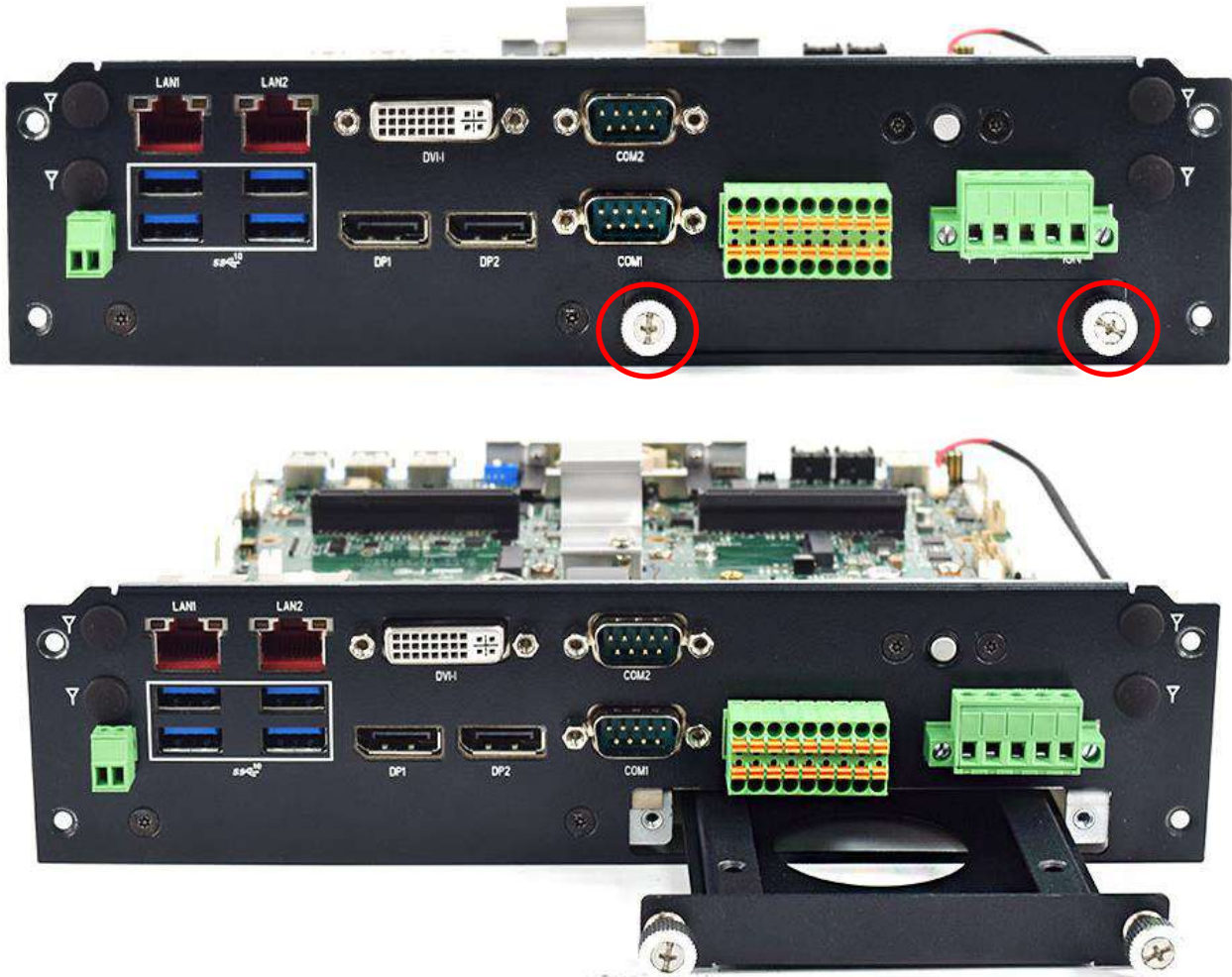

2. Lock the 2.5" HDD with HDD bracket using 4 screws.

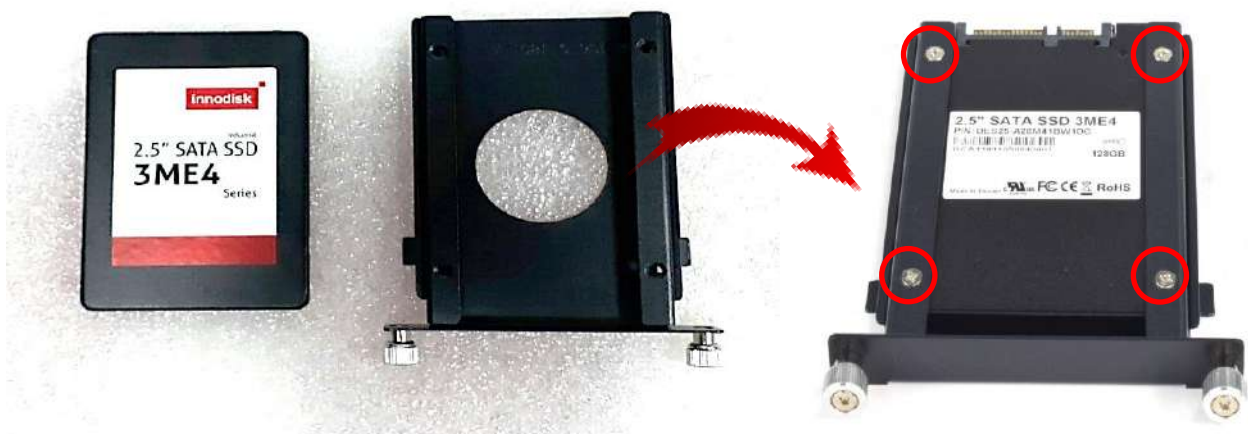

3. Push the HDD bracket back and then fasten the sun screws.



4. Hold the main system body and mount it vertically to the lower system



5. Unscrew the six screws (M3x5L) highlighted below.

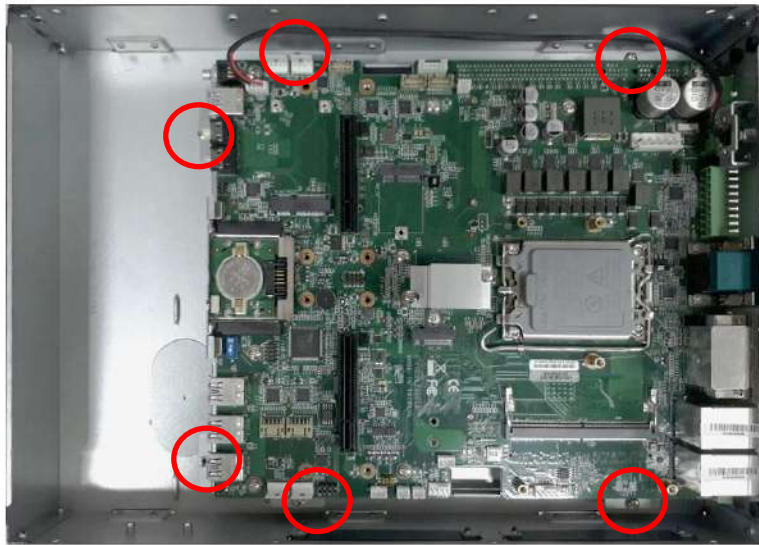

6. Unscrew 4 screws (M3x5L) on the front side.

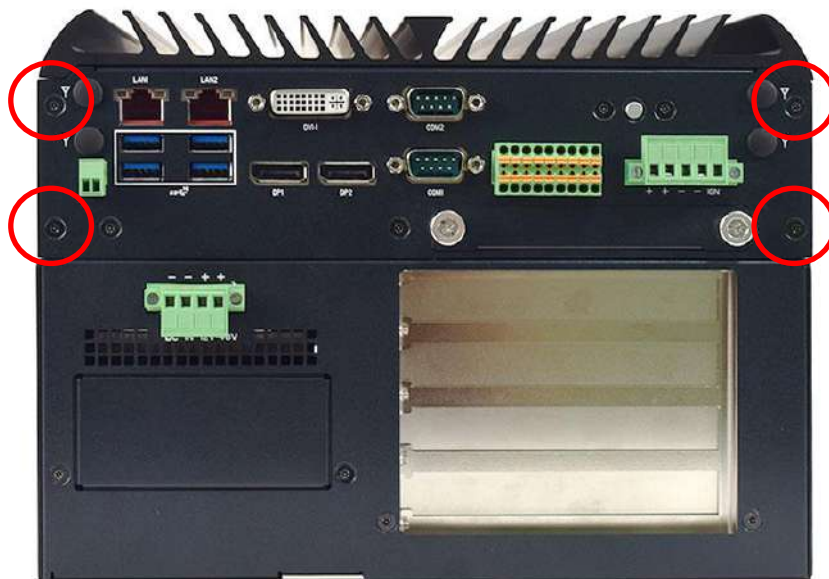

3.9 Install M.2 SSD card

VCO-6000-RPL series PCBA has an M.2 KB slot on the top, M2_B Key currently supports SSD application.

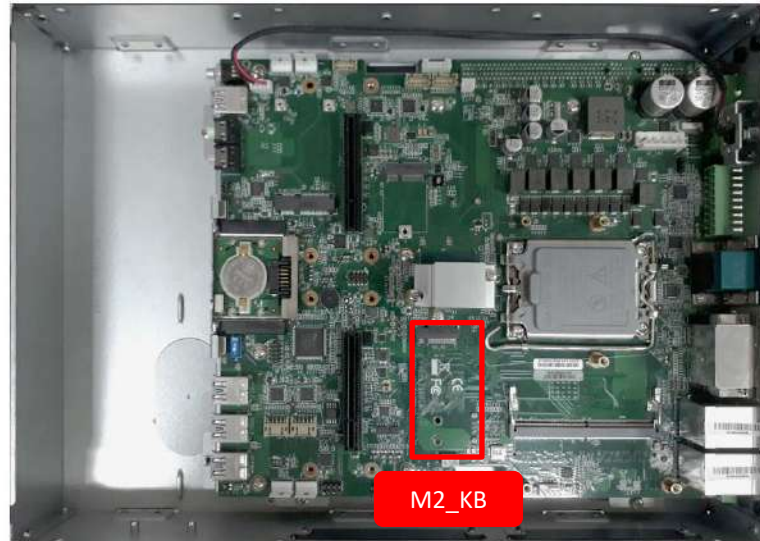

1. Insert Mini PCIe card at a 45-degree angle.

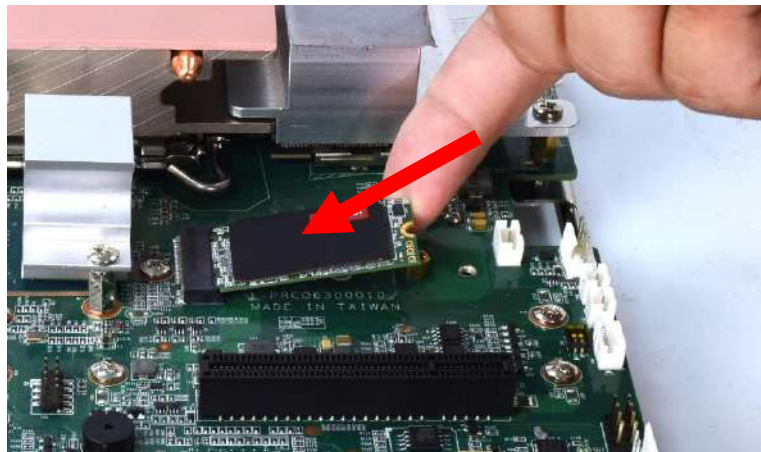

2. Gently press the Mini PCIe card down against the board and secure it with one screw (M3x5L).

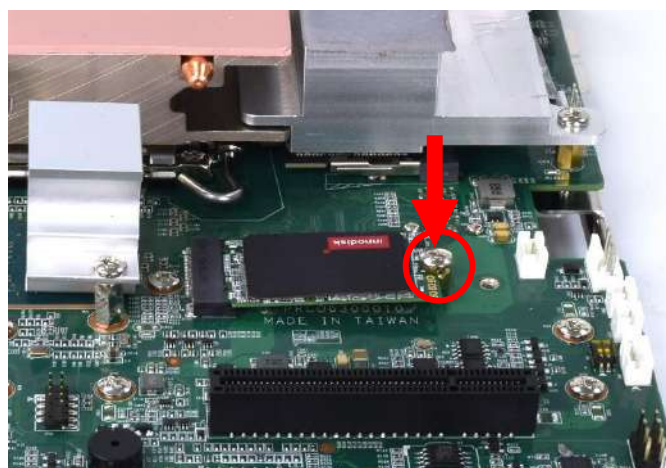

3.10 Install WiFi Module

VCO-6000-RPL series PCBA has an M.2 KE slot on the top, M2_E Key currently supports WiFi application

1. Insert M.2 E Key card at 45-degree angle.

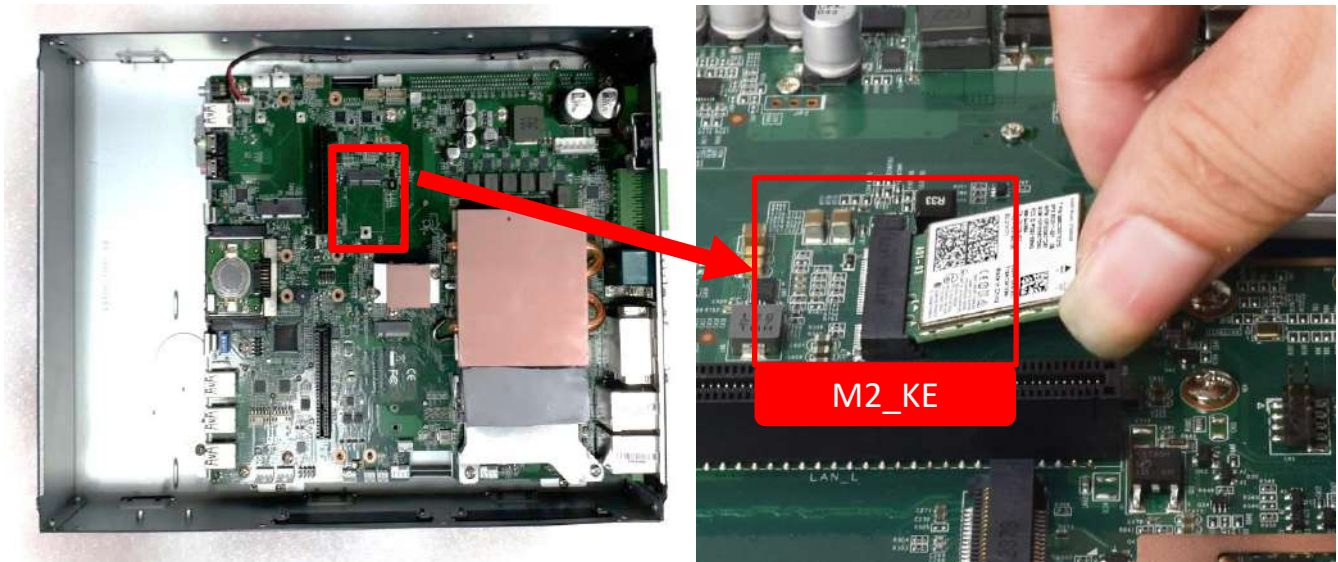

2. Press the M.2 E Key card down and secure it with one screw (M3x5L).

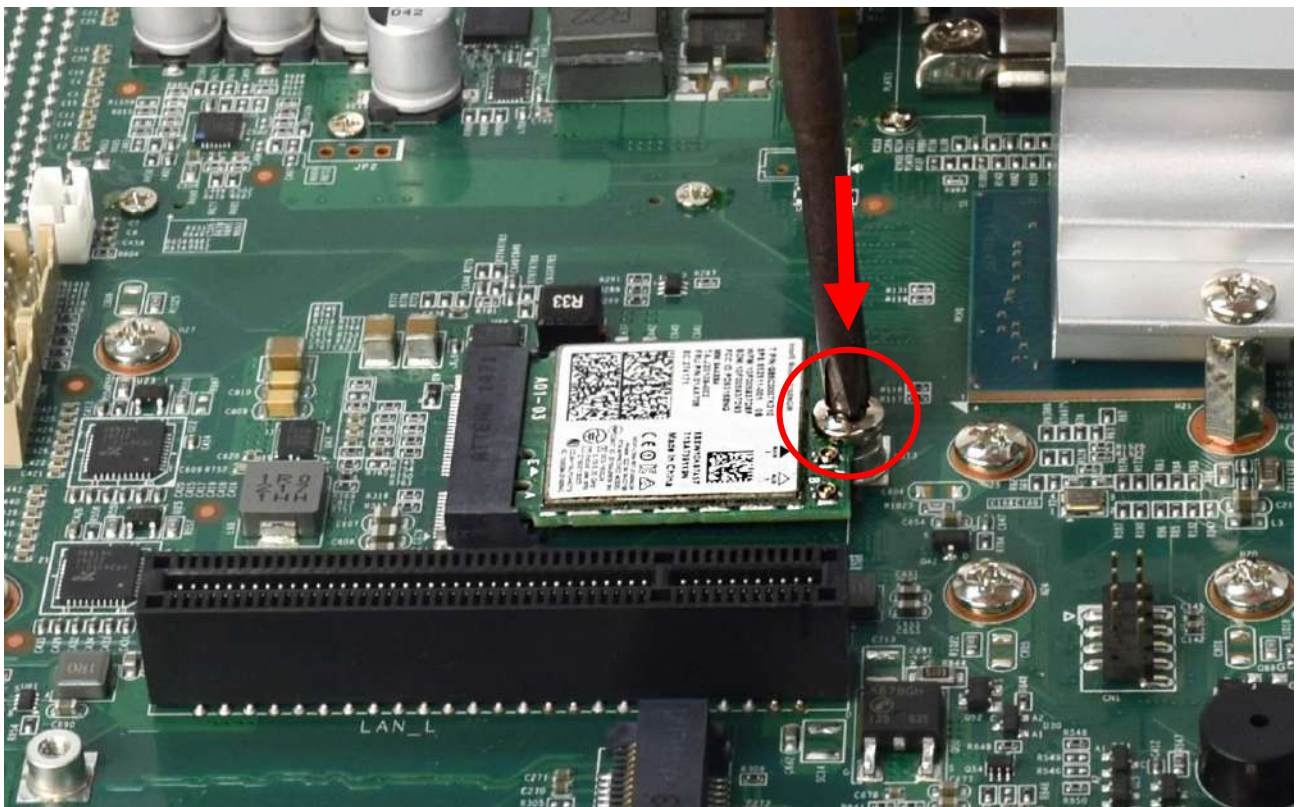

3. VCO-6000-RPL series system has four antenna holes. First, remove two left antenna hole plugs on the system panel.

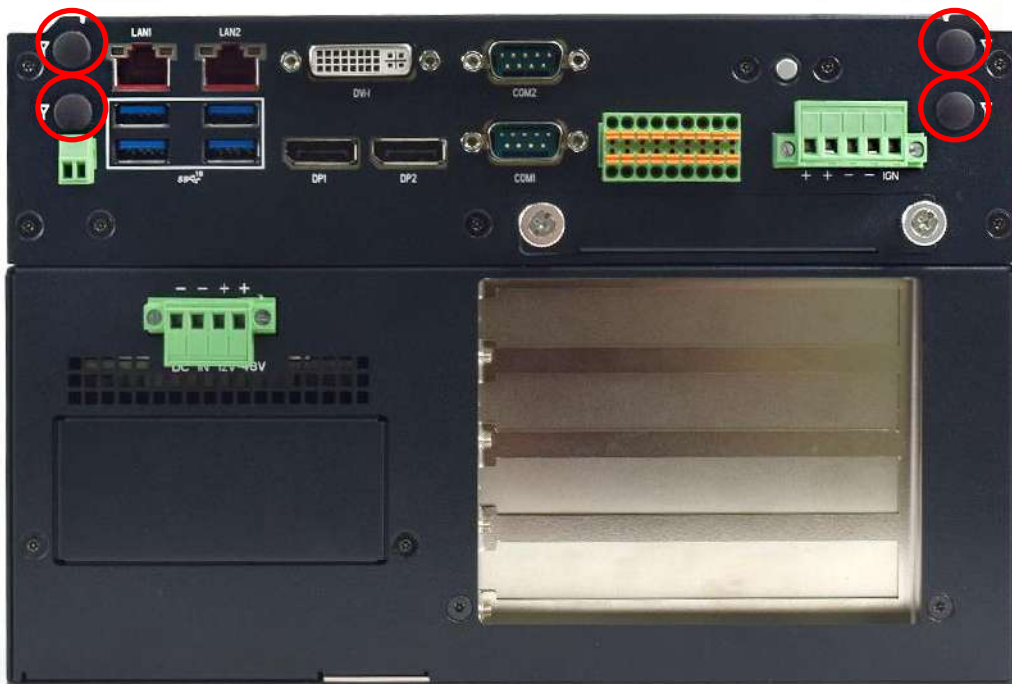

4. Have the antenna jack penetrate through the hole, and fasten the nut with SMA jack.

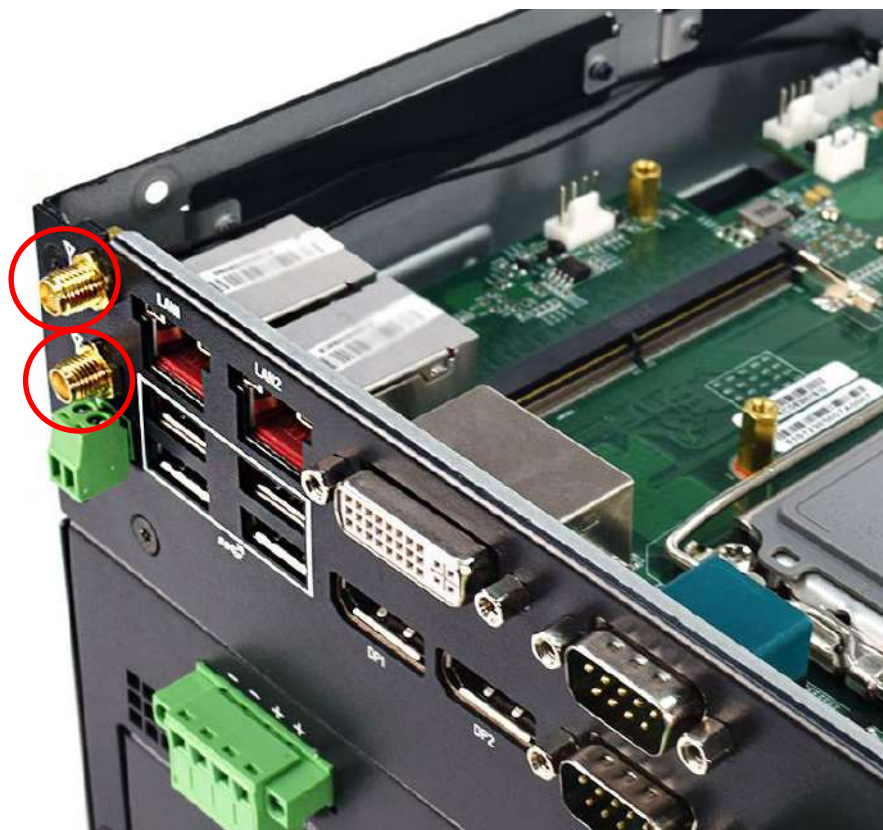

5. Assemble the antenna and SMA jack together.



6. Attach the RF connector at the cable-end onto the communication module.



3.11 Install Mini PCIe card / 4G LTE

The VCO-6000-RPL Series PCBA has Mini PCIe slots on the top. It currently supports 4G LTE applications.

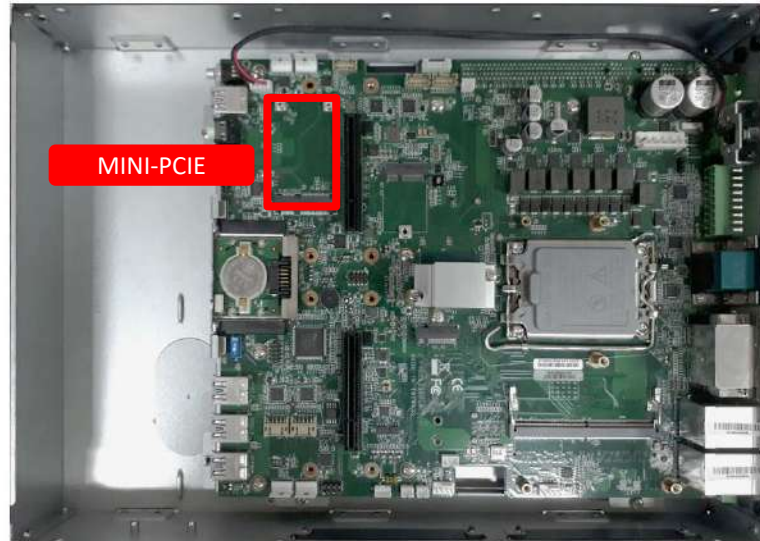

1. Insert Mini PCIe card at a 45-degree angle.

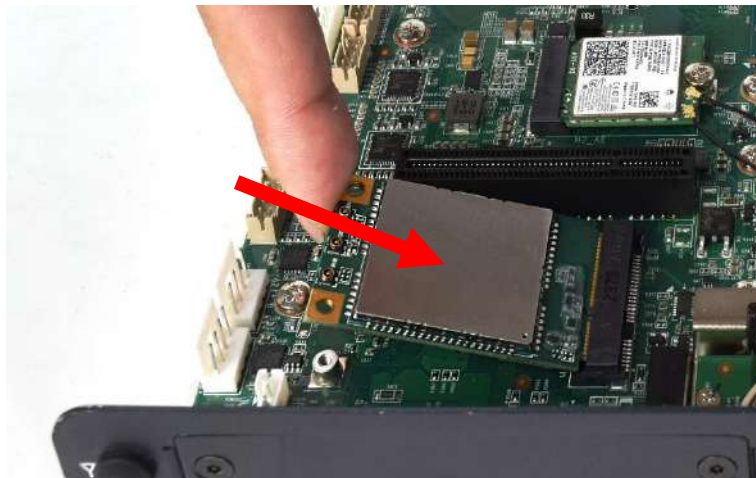

2. Gently press the Mini PCIe card against the board and secure it with two screws (M2x3.7L).

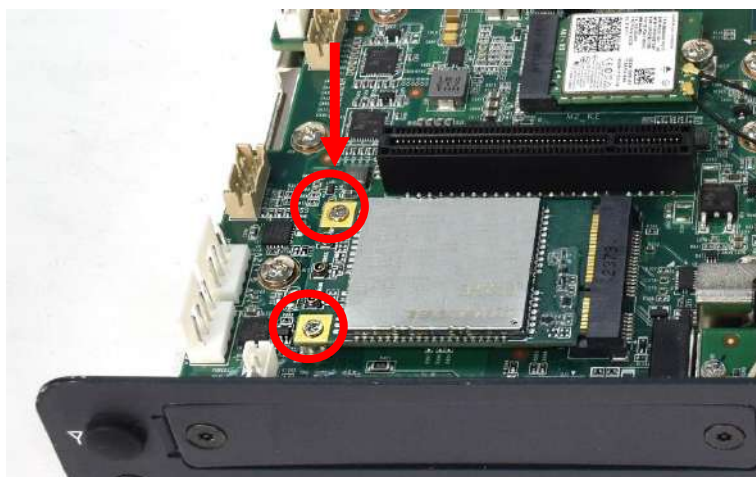

3.12 Install Antenna

1. Remove two right antenna hole cover on the system panel.

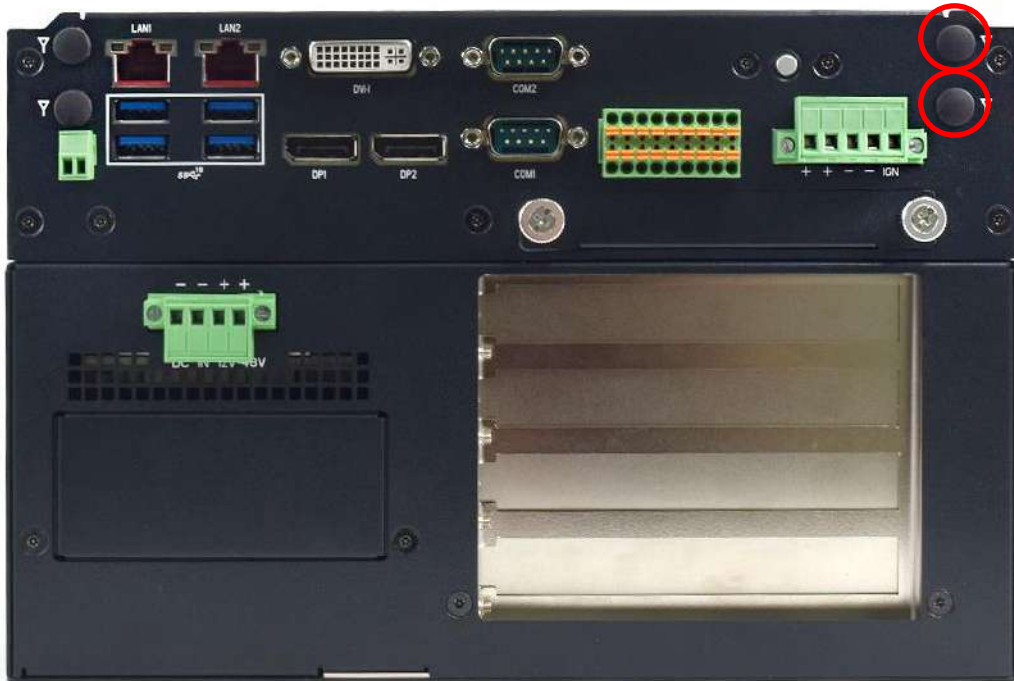

2. Jack penetrate through the hole, and fasten the nut with SMA jack.



3. Assemble the antenna and SMA jack together.



4. Attach the RF connector at the cable-end onto the communication module.

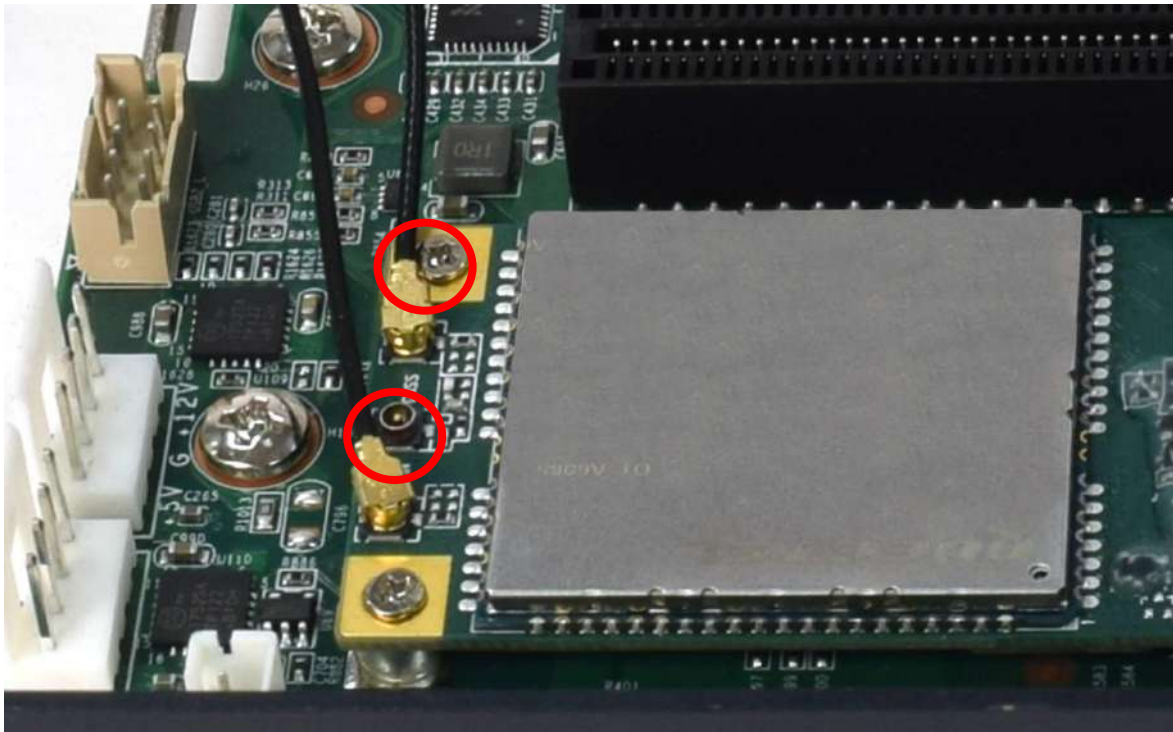

3.13 Install graphic Card (For Superior Machine Vision System)

1. Loosen and remove the three screws from the base

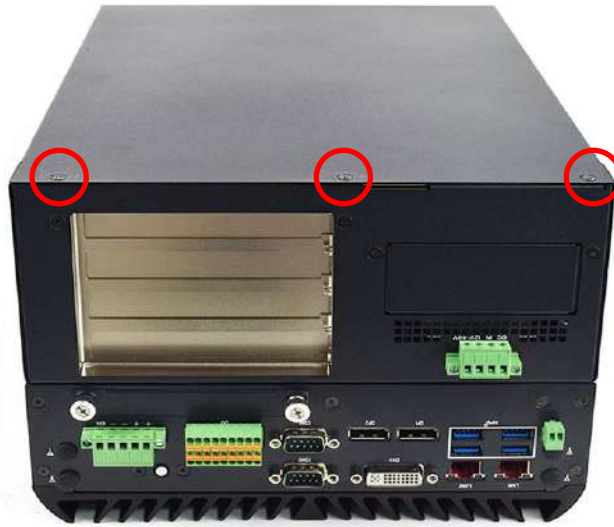

2. Slide the base backward



3. Lift the base vertically upward



4. Remove the three screws in the circle below.

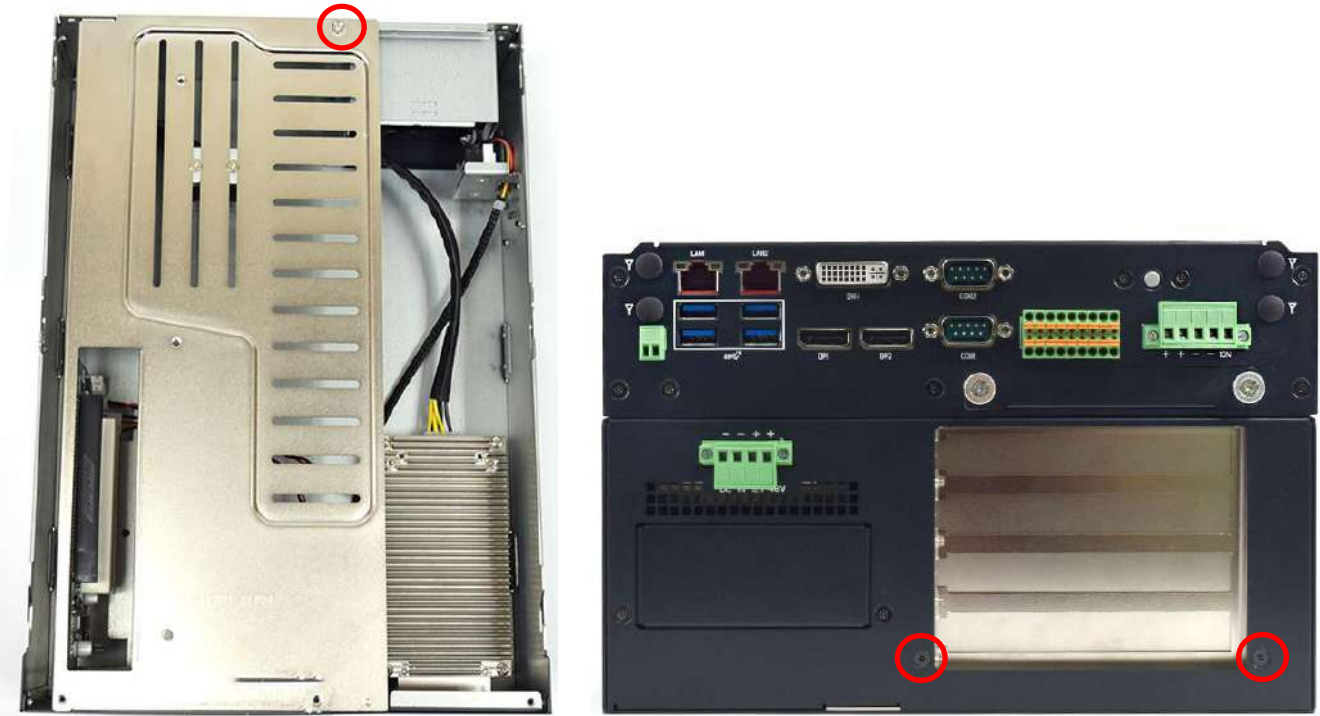

5. Disconnect the fan and the temperature power control cable.



6. Unscrew the two screws to remove the I/O shield.



7. Unscrew the card bracket screws to remove the bracket from the expansion slots.

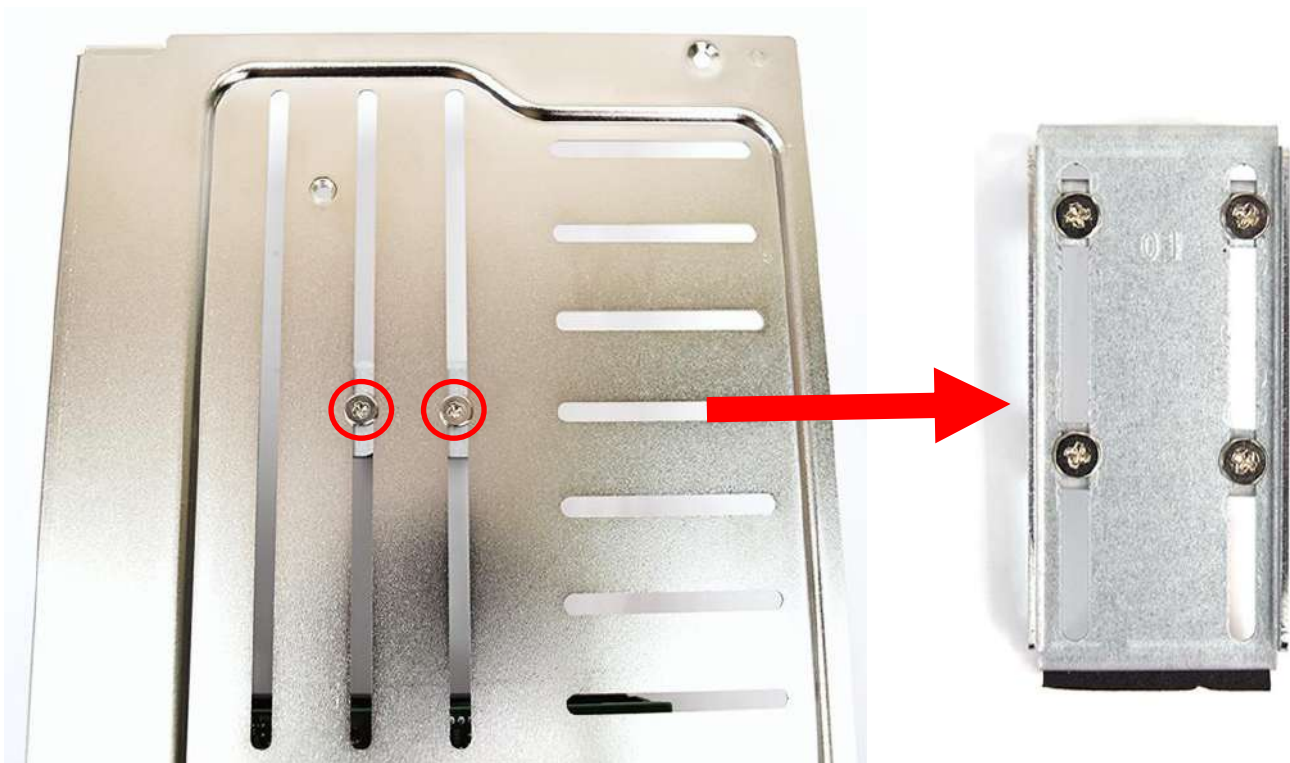

8. Install the graphic card and ensure the gold finger is inserted into the slot. and then fasten the screws.



9. Adjust the arm until it holds the card firmly in place. Then fasten the Four screw on the holder.

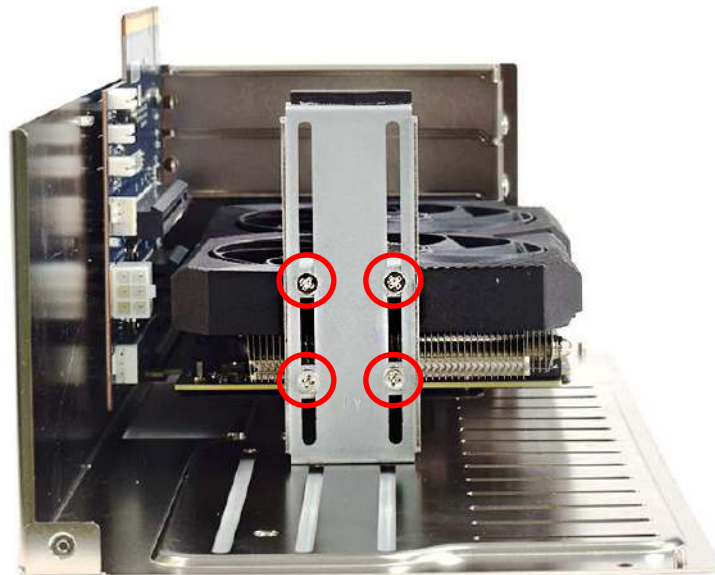

10. Fasten the two screws.



11. Insert the temperature power control and fan cables into the Riser Card, then connect the power cord from the power board to the graphics card.

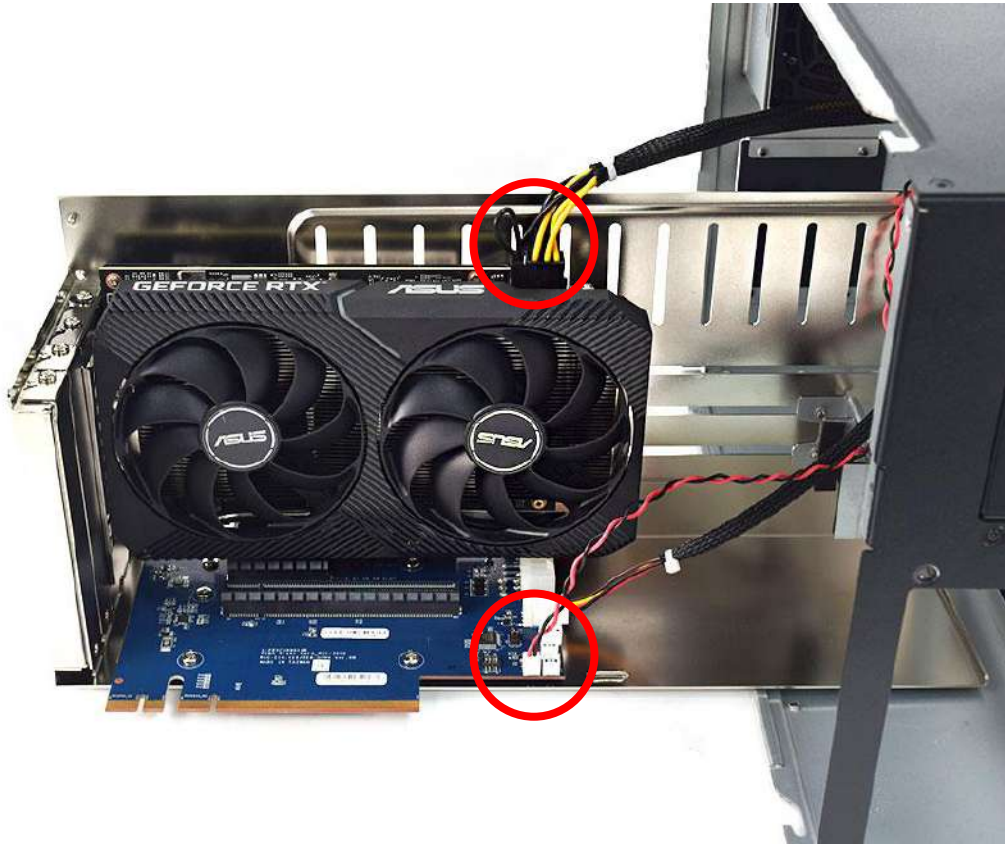

12. Put the graphic expansion module into the expansion chassis.



13. Fasten the three screws in the circle below.

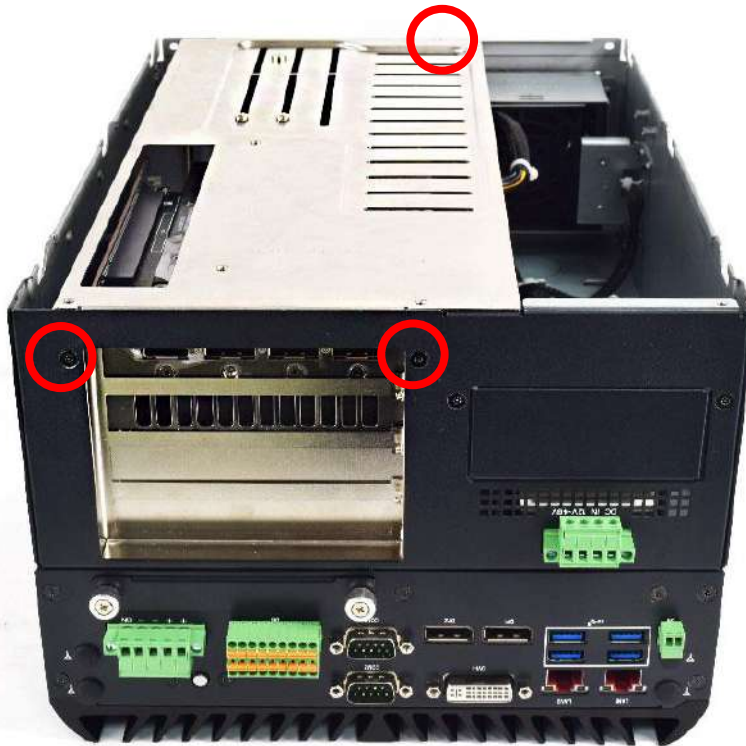

14. Install the base cover and slide it forward to secure

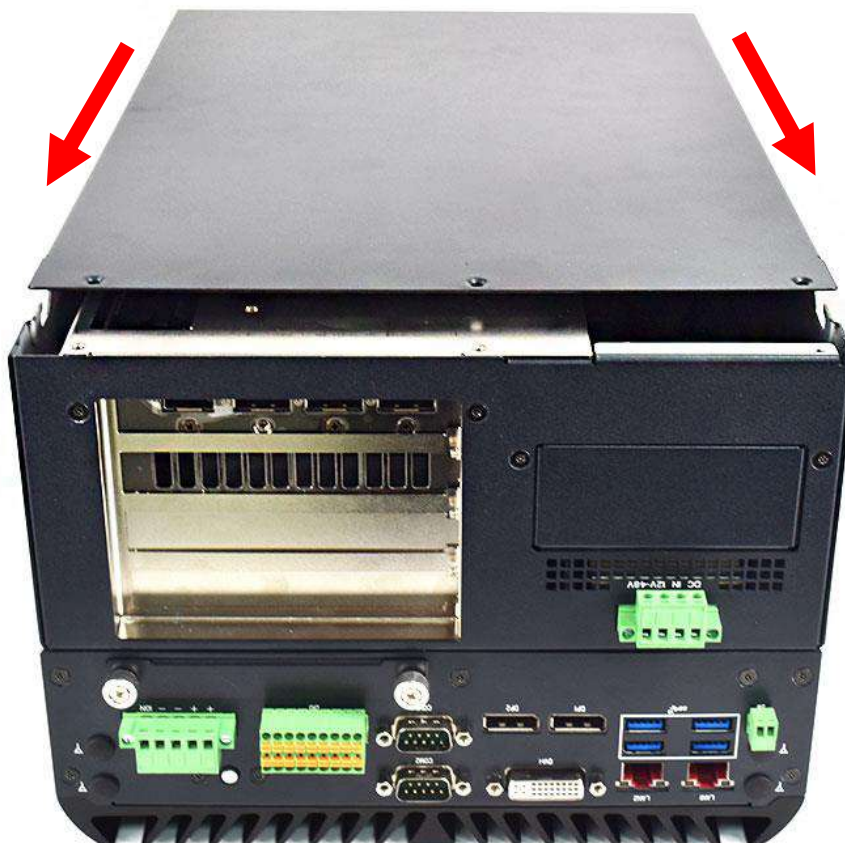

15. Install the three screws on the base.



16. Lock the top cover and install 4 screws (M3x5L) on both top sides

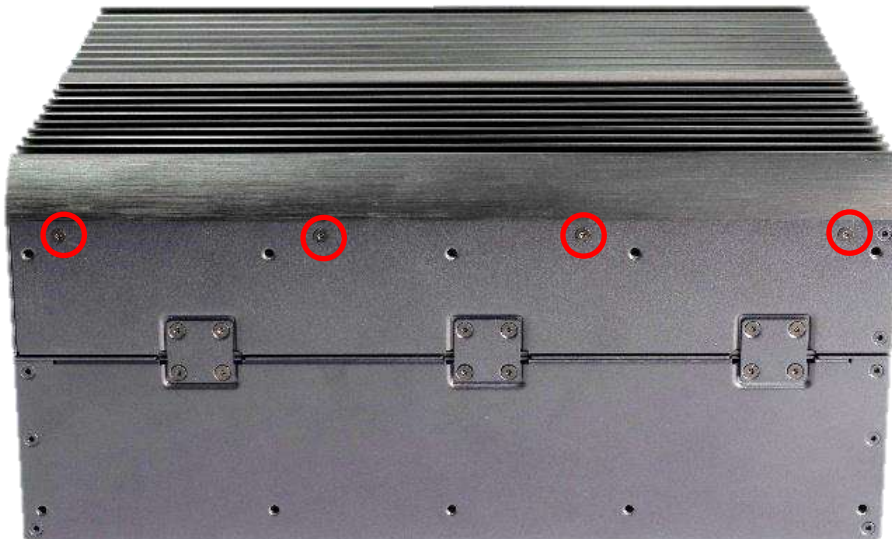

3.14 Install wall mount kit

1. Wall mount kit is available for the VCO-6000-RPL included in the standard package.



2. Lock the wall mount kit with ten screws

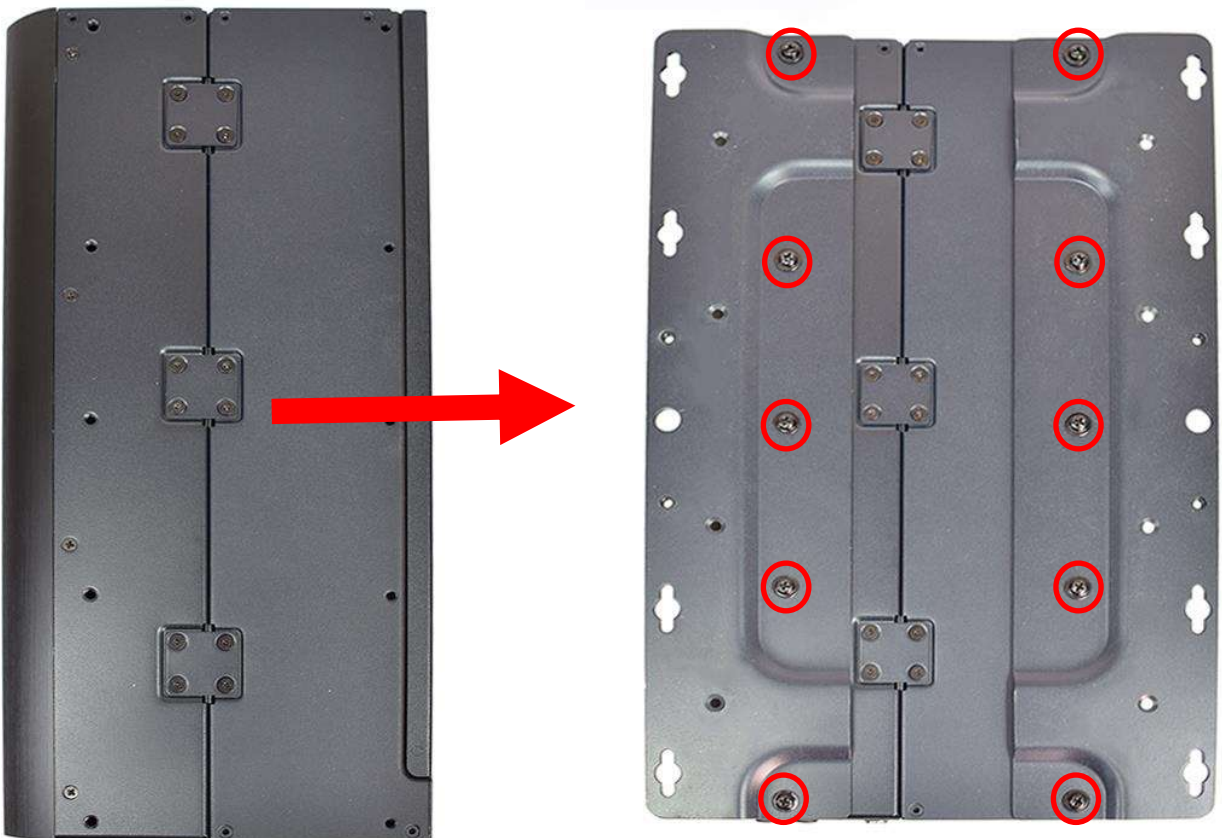

3.15 AC Adapter with 4P terminal block

* 24V requires 4-pin terminal block for card/storage expansion

1. AC adapter 4P wiring diagram

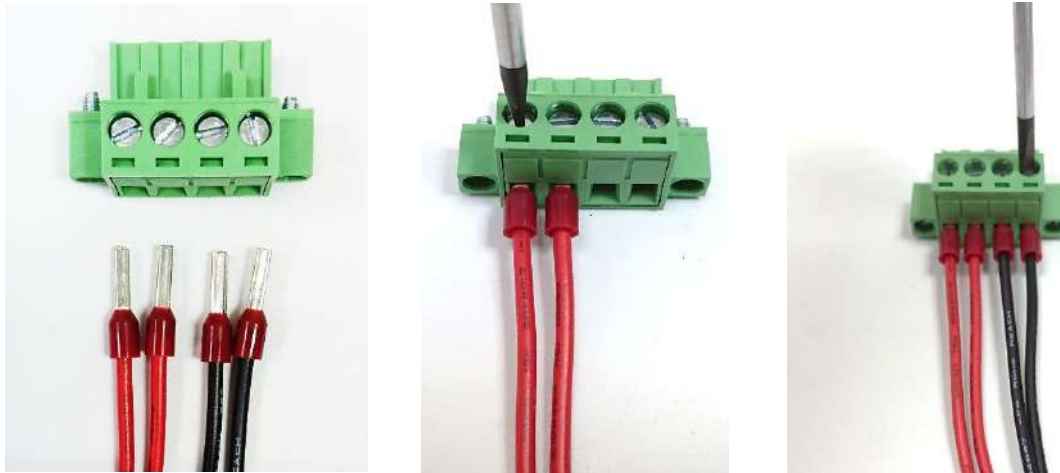

2. DC power input 4P wiring diagram

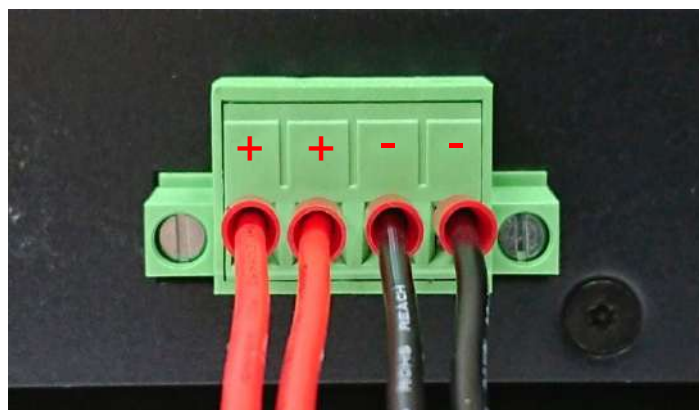
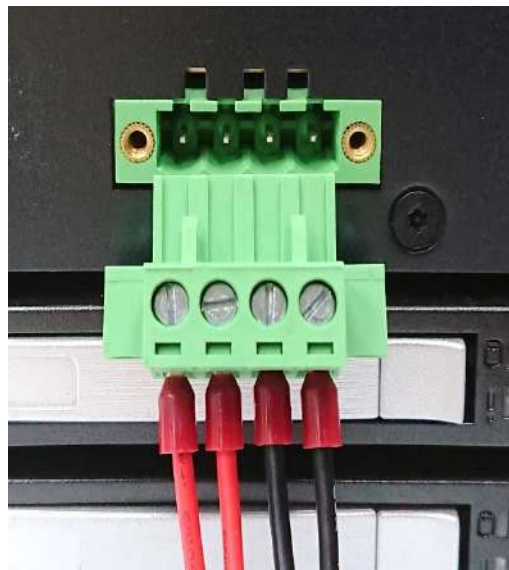

3.16 AC Adapter with 5P terminal block

1. 5P Wiring Diagram of AC Adapter

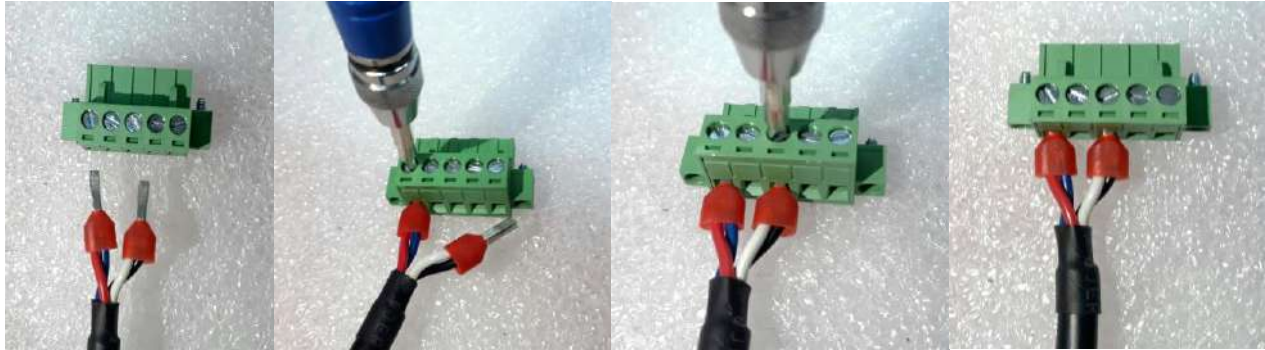

2. DC power input 5P wiring diagram

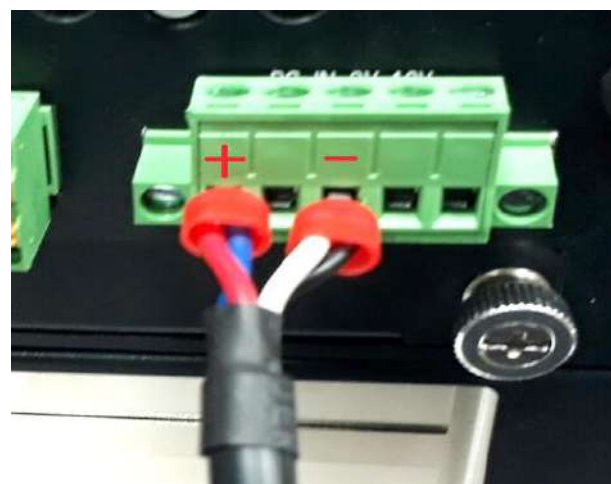

Chapter 4

BIOS Setup

4.1 BIOS Introduction

The BIOS provides an interface to modify the configuration. When the battery is removed, all the parameters will be reset.

BIOS Setup

Power on the embedded system and by pressing immediately allows you to enter the setup screens. If the message disappears before you respond and you still wish to enter the Setup, restart the system by turning it OFF and ON or pressing the RESET button.

You may also restart the system by simultaneously pressing <Ctrl>, <Alt>, and <Delete> keys.

Control Keys	
<→> <←>	Select Screen
<↑> <↓>	Select Item
<Enter>	Select
<Page Up/+>	Increases the numeric value or makes changes
<Page Down/->	Decreases the numeric value or makes changes
<F1>	General Help
<F2>	Previous Value
<F3>	Load Optimized Defaults
<F4>	Save Configuration and Exit
<Tab>	Select Setup Fields
<Esc>	Exit BIOS Setup

Main Setup

The main menu lists the setup functions you can make changes to. You can use the arrow keys (↑↓) to select the item. The on-line description of the highlighted setup function is displayed at the bottom of the screen.

General Help <F1>

The BIOS setup program provides a General Help screen. You can call up this screen from any menu by simply pressing <F1>. The Help screen lists the appropriate keys to use and the possible selections for the highlighted item. Press <Esc> to exit the Help screen.

4.2 Main Setup

Press to enter BIOS CMOS Setup Utility. The Main setup screen is showed as following when the setup utility is entered. System Date/Time is set up in the Main Menu.

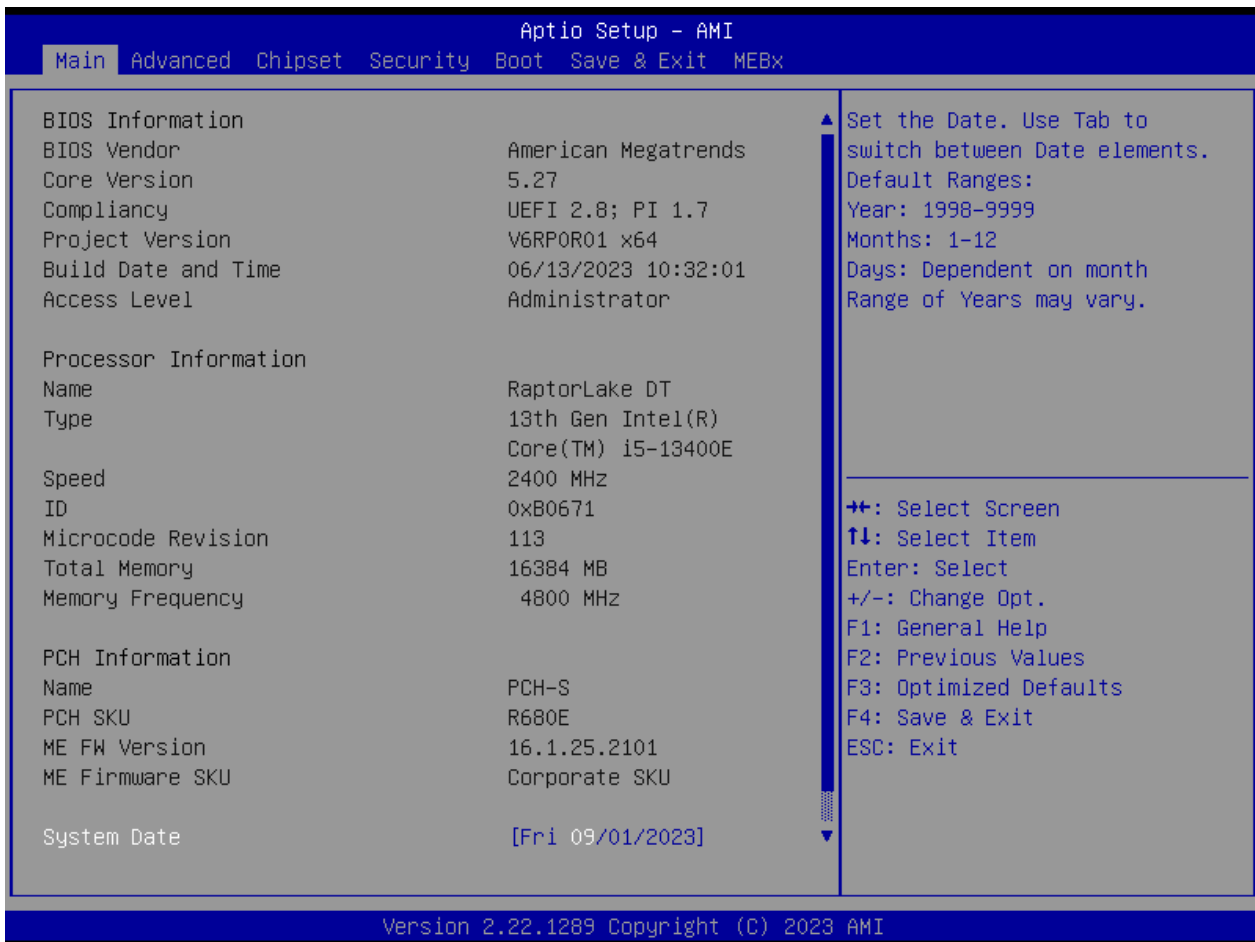

■ System Date

Set the system date. Please use <Tab> to switch between data elements.

■ System Time

Set the system time. Please use <Tab> to switch between time elements.

4.3 Advanced Setup

Aptio Setup - AMI		
Main	Advanced	Chipset Security Boot Save & Exit MEBx
<ul style="list-style-type: none"> ▶ Connectivity Configuration ▶ CPU Configuration ▶ PCH-FW Configuration ▶ SATA Configuration ▶ Trusted Computing ▶ ACPI Settings ▶ Super IO Configuration ▶ Hardware Monitor ▶ Power IGN Mode ▶ S5 RTC Wake Settings ▶ Serial Port Console Redirection ▶ USB Configuration ▶ Network Stack Configuration ▶ CSM Configuration ▶ NVMe Configuration ▶ Intel(R) Rapid Storage Technology 	<p>Configure Connectivity related options</p> <hr/> <p> ⇐⇐: Select Screen ↑↓: Select Item Enter: Select +/-: Change Opt. F1: General Help F2: Previous Values F3: Optimized Defaults F4: Save & Exit ESC: Exit </p>	<p>Lan_1 MAC Address AC-40-EA-02-2D-AE</p> <p>Lan_2 MAC Address AC-40-EA-02-2D-C5</p>
Version 2.22.1289 Copyright (C) 2023 AMI		

4.3.1 Connectivity Configuration



Item	Options	Description
CNVi Mode	Disable Integrated, Auto Detection[Default]	This option configures Connectivity. [Auto Detection] means that if Discrete solution is discovered it will be enabled by default. Otherwise Integrated solution (CNVi) will be enabled; [Disable Integrated] disables Integrated Solution. NOTE: When CNVi is present, the GPIO pins that are used for radio interface cannot be assigned to the other native function.
Wi-Fi Core	Enabled[Default], Disabled	This is an option intended to Enable/Disable Wi-Fi Core in CNVi
BT Core	Enabled[Default], Disabled	This is an option intended to Enable/Disable BT Core in CNVi.

4.3.2 CPU Configuration

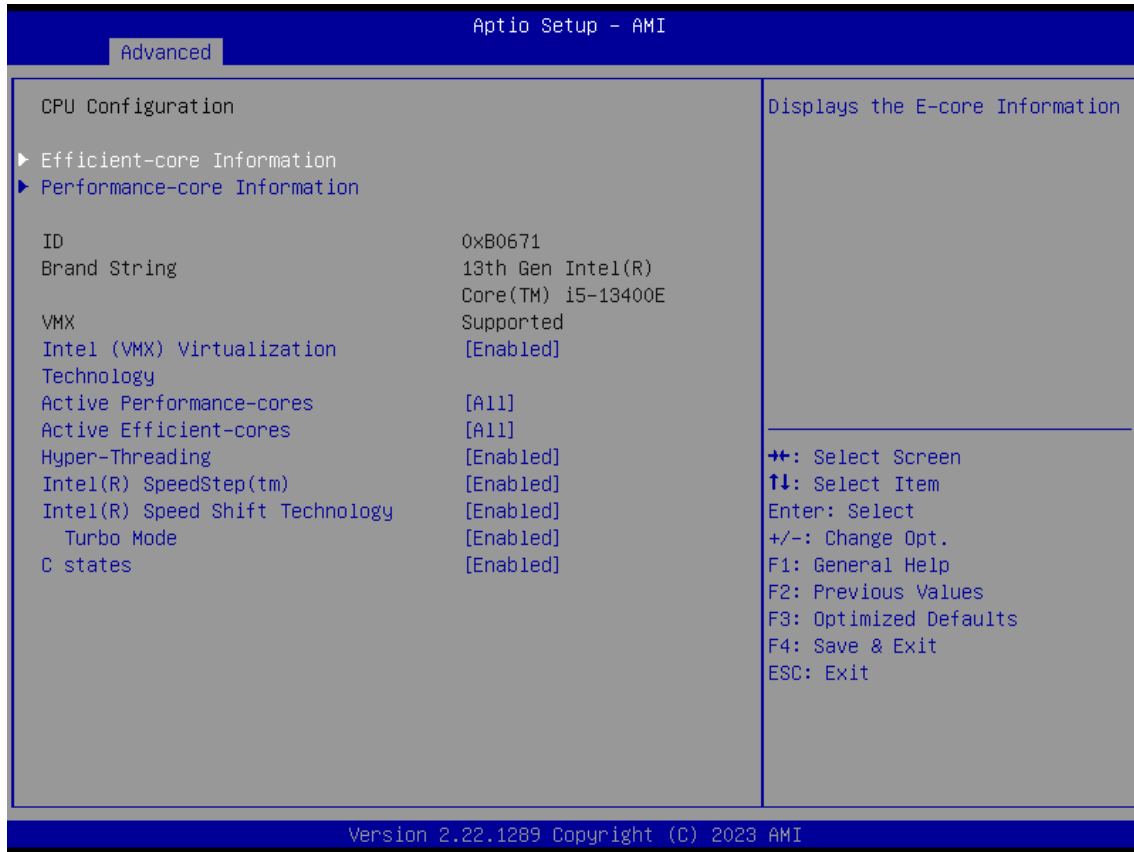

Item	Options	Description
Intel (VMX) Virtualization Technology	Disabled, Enabled[Default]	When enabled, a VMM can utilize the additional hardware capabilities provided by Virtualization Technology.
Active Performance-cores	All[Default] , 5,4,3, 2,1	Number of P-cores to enable in each processor package. Note: Number of Cores and E-cores are looked at together. When both are {0,0}, Pcode will enable all cores.
Active Efficient-cores	All[Default] , 3,2, 1,0	Number of E-cores to enable in each processor package. Note: Number of Cores and E-cores are looked at together. When both are {0,0}, Pcode will enable all cores.
Hyper-Threading	Disabled, Enabled[Default]	Enabled for Windows XP and Linux (OS optimized for Hyper-Threading Technology) and Disabled for other OS (OS not optimized for Hyper-Threading Technology).
Intel(R) SpeedStep(tm)	Disabled, Enabled[Default]	Allows more than two frequency ranges to be supported.
Intel(R) Speed Shift Technology	Disabled, Enabled[Default]	Enable/Disable Intel(R) Speed Shift Technology support. Enabling will expose the CPPC v2 interface to allow for hardware controlled P-states.
Turbo Mode	Disabled, Enabled[Default]	Enable/Disable processor Turbo Mode.
C states	Disabled, Enabled[Default]	Enable/Disable CPU Power Management. Allows CPU to go to C states when it's not 100% utilized.

4.3.2.1 Efficient-core Information

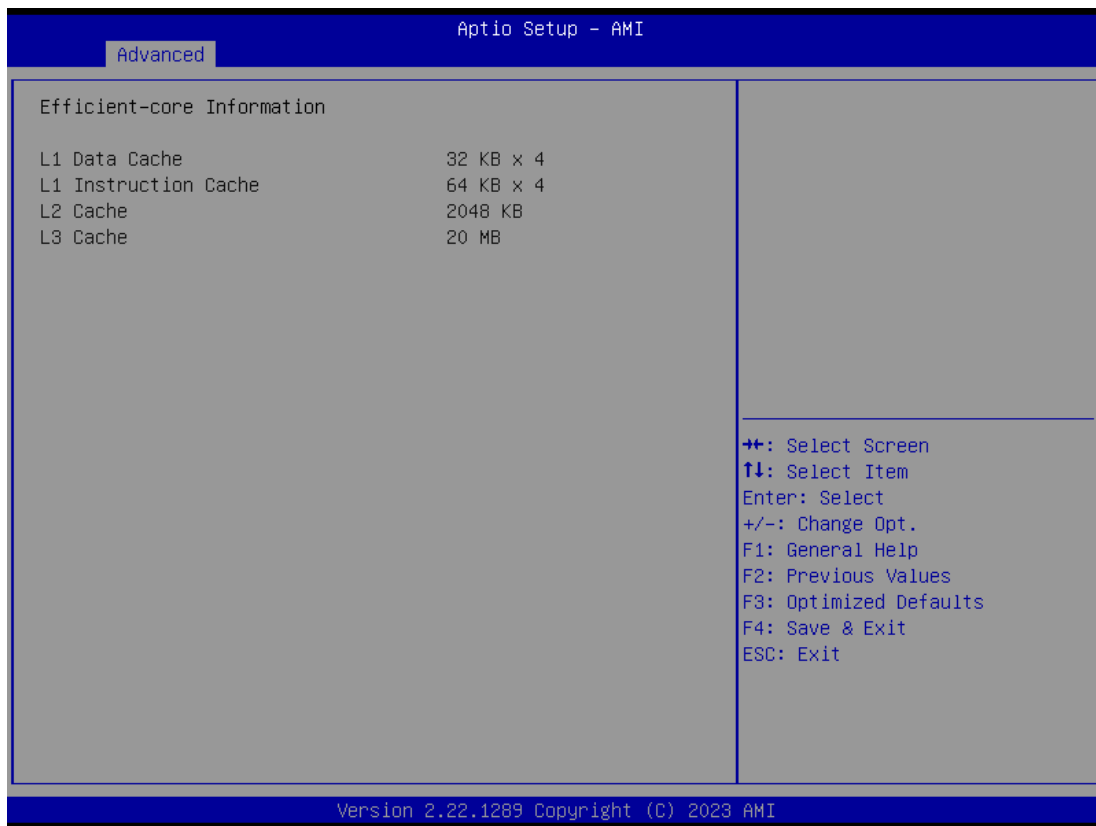

4.3.2.2 Performance-core Information

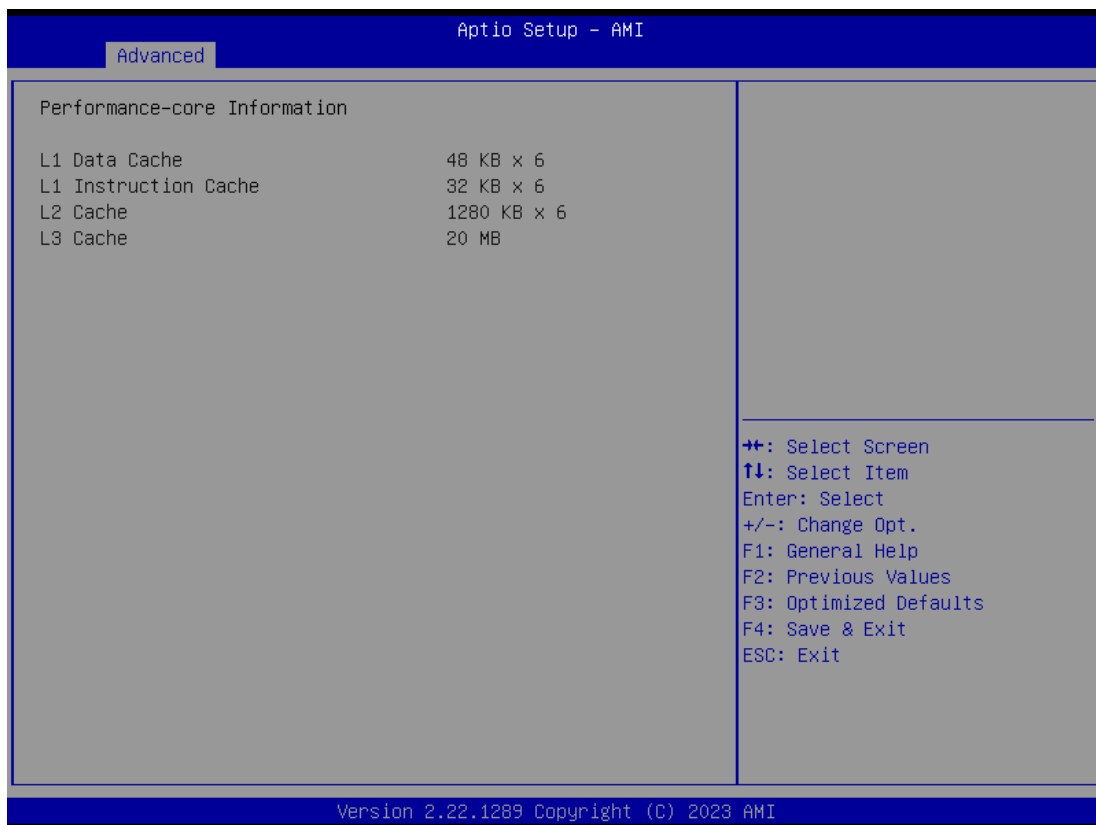

4.3.3 PCH-FW Configuration

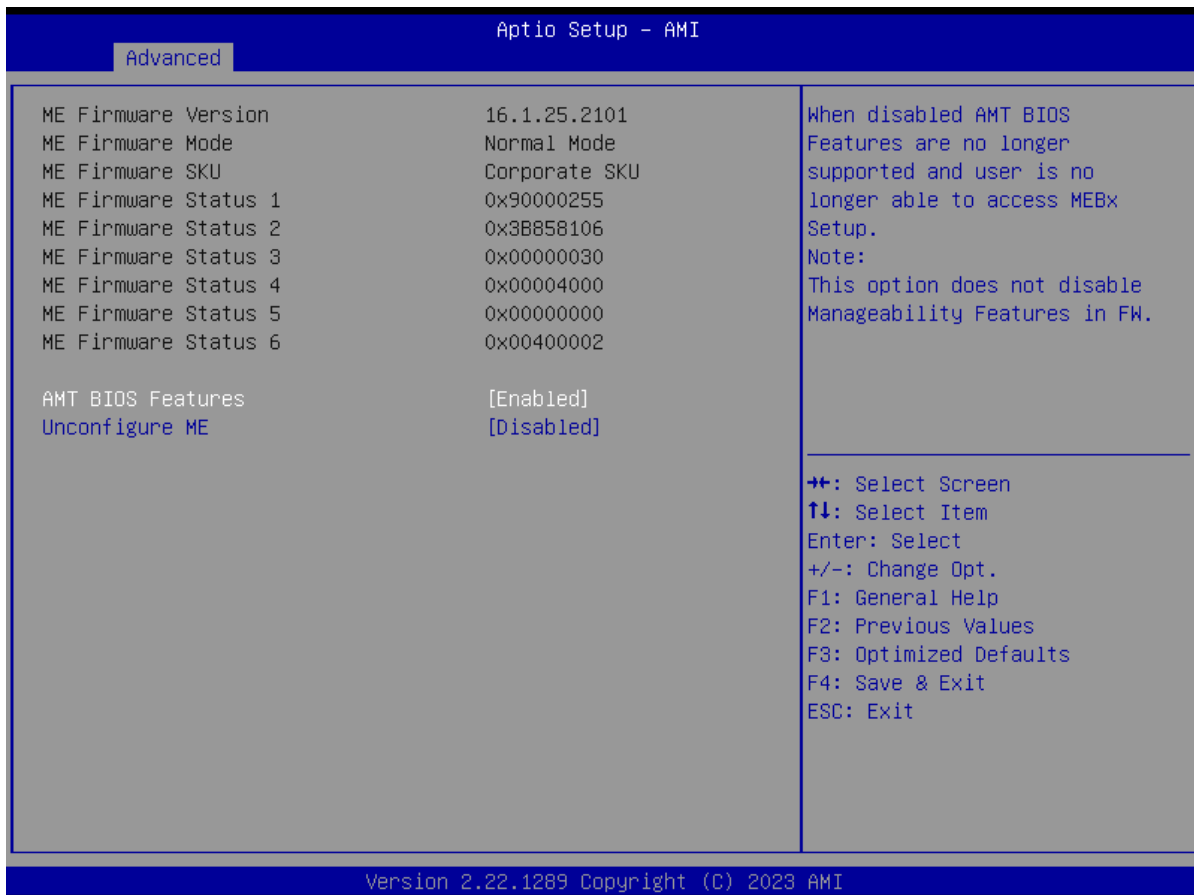

Item	Options	Description
AMT BIOS Features	Disabled, Enabled[Default]	When disabled AMT BIOS Features are no longer supported and user is no longer able to access MEBx Setup. Note: This option does not disable Manageability Features in FW.
Unconfigure ME	Disabled[Default], Enabled	Unconfigure ME with resetting MEBx password to default on next boot.

4.3.4 SATA and RST Configuration

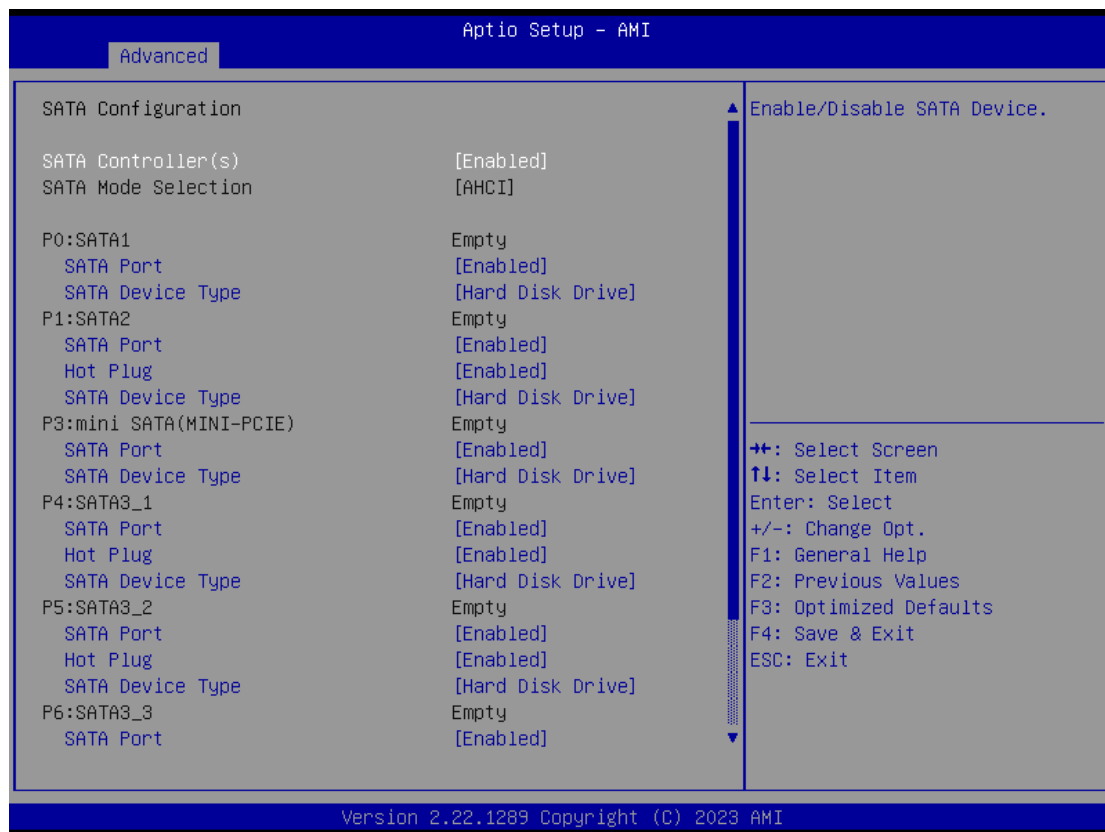

Item	Options	Description
SATA Controller(s)	Enabled[Default] Disabled	Enable/Disable SATA Device.
SATA Port	Disabled, Enabled[Default]	Enable/Disable SATA Port.
Hot Plug	Disabled, Enabled[Default]	Designates this port as Hot Pluggable.
SATA Device Type	Hard Disk Drive[Default] , Solid State Drive	Identify the SATA port is connected to Solid State Drive or Hard Disk Drive.

4.3.5 RST (UEFI RAID) Configuration

How to set the UEFI RAID:

1. When set to “Enable VMD controller”, please save change reset system.



2. After reboot the system, please into BIOS utility and then will see “Intel (R) Rapid Storage Technology”

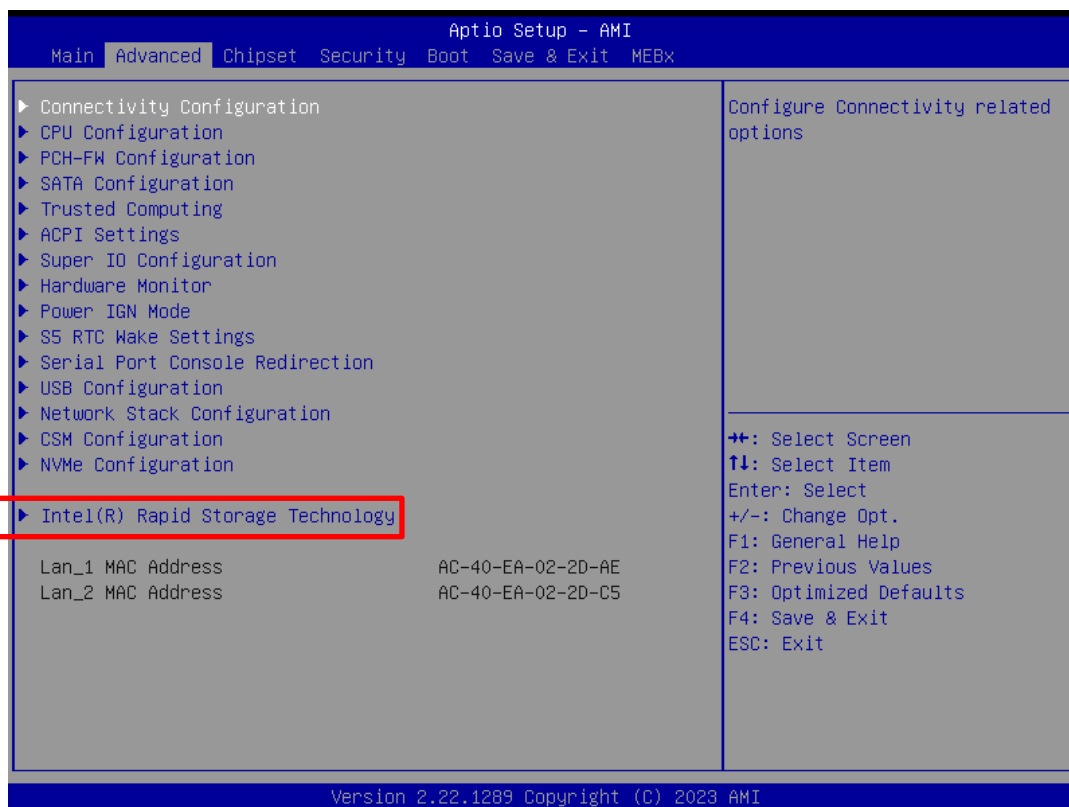

3. Into Intel(R) Rapid Storage Technology, and start create RAID volume.

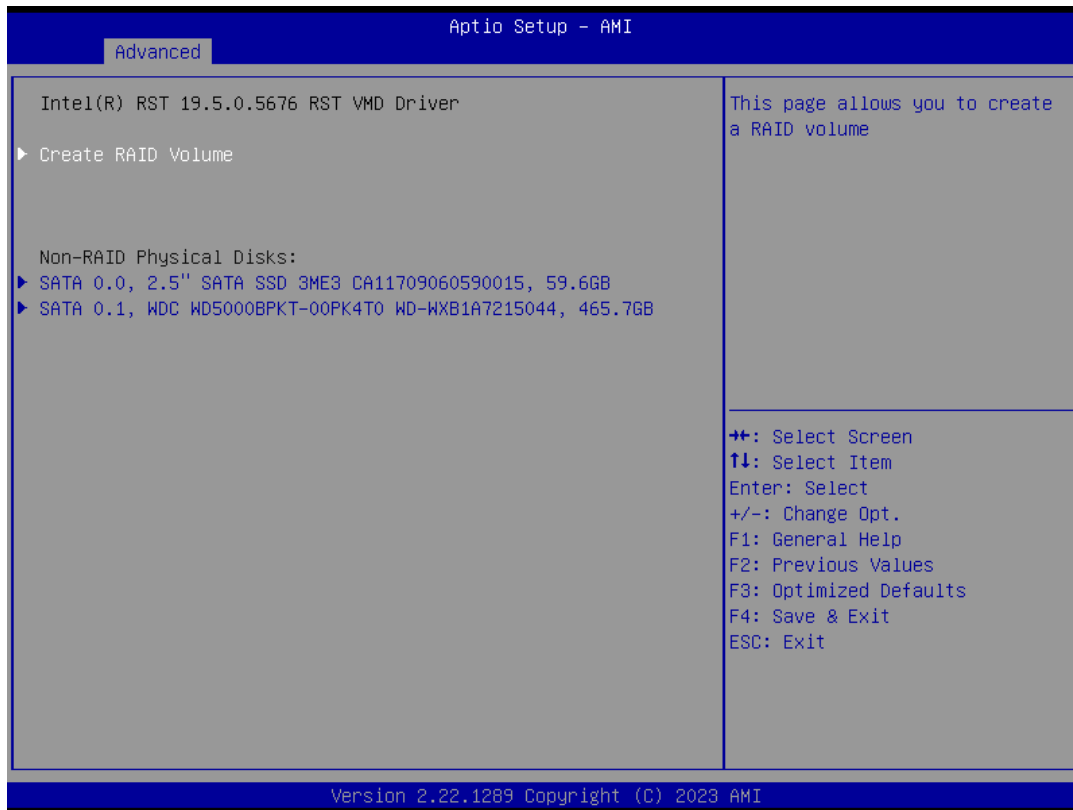

4. Start Create the RAID

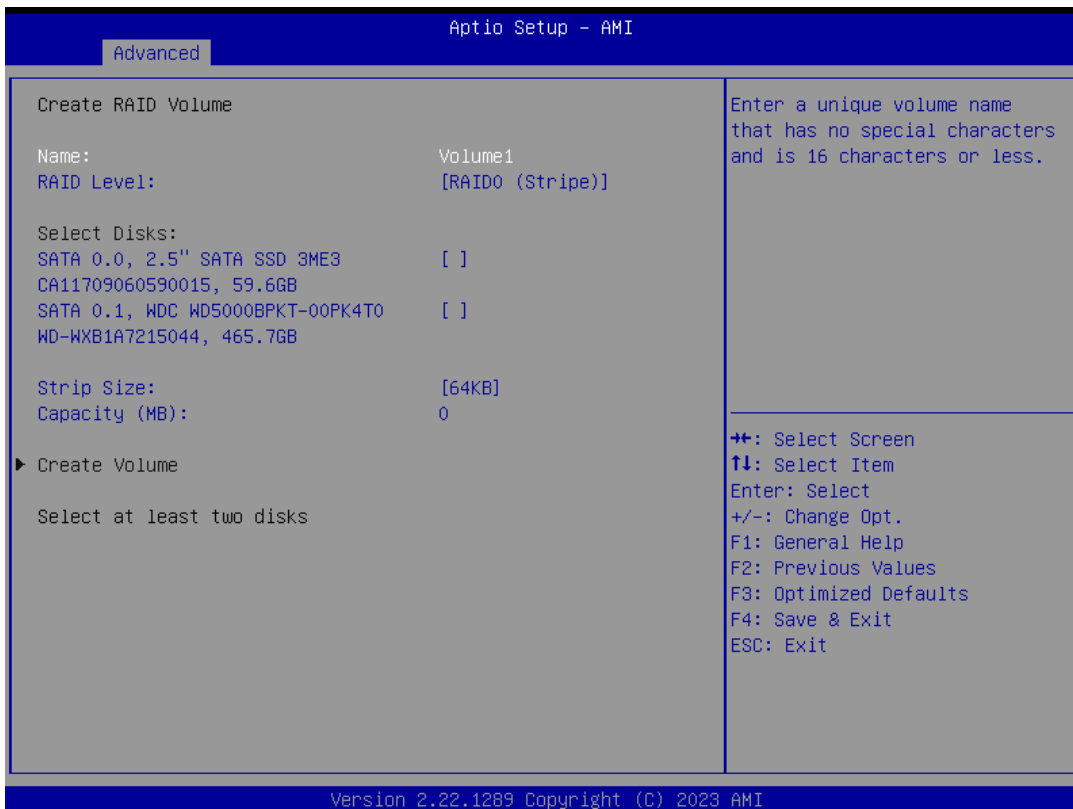

- Select Disk that you want to do the RAID
- Select [x]; No-Select []

4.3.6 Trusted Computing



Item	Options	Description
Security Device Support	Enabled, Disabled[Default] ,	Enable/Disable BIOS support for security device. O.S. will not show Security Device.TCG EFI protocol and INT1A interface will not be available.
Pending operation	None[Default] , TPM Clear	Schedule an Operation for the Security Device. NOTE: Your Computer will reboot during restart in order to change State of Security Device.

4.3.7 ACPI Settings

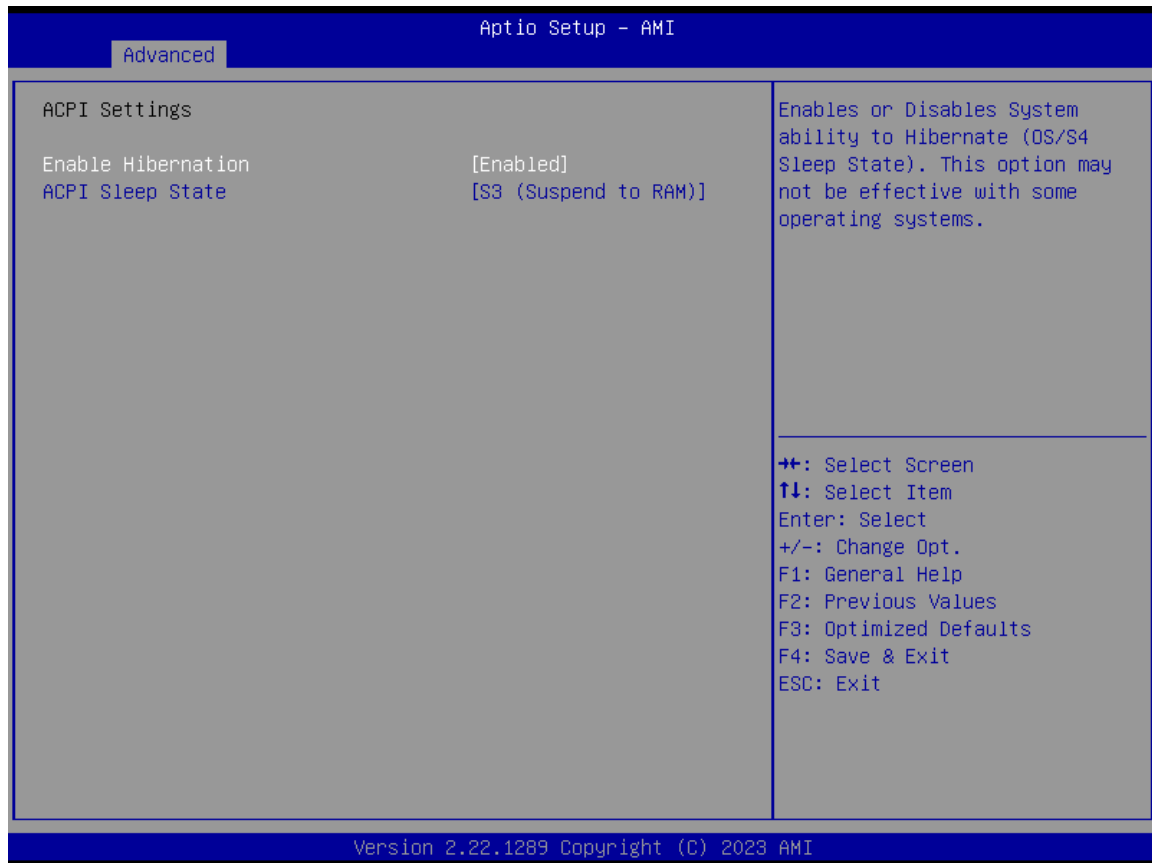

Item	Options	Description
Enable Hibernation	Disabled , Enabled[Default],	Enables or Disables System ability to Hibernate (OS/S4 Sleep State). This option may not be effective with some operating systems.
ACPI Sleep State	Suspend Disabled, S3 (Suspend to RAM)[Default]	Select the highest ACPI sleep state the system will enter when the SUSPEDN button is pressed.

4.3.8 Super IO Configuration

This setting allows you to select options for the Super IO Configuration, and change the value of the selected option.

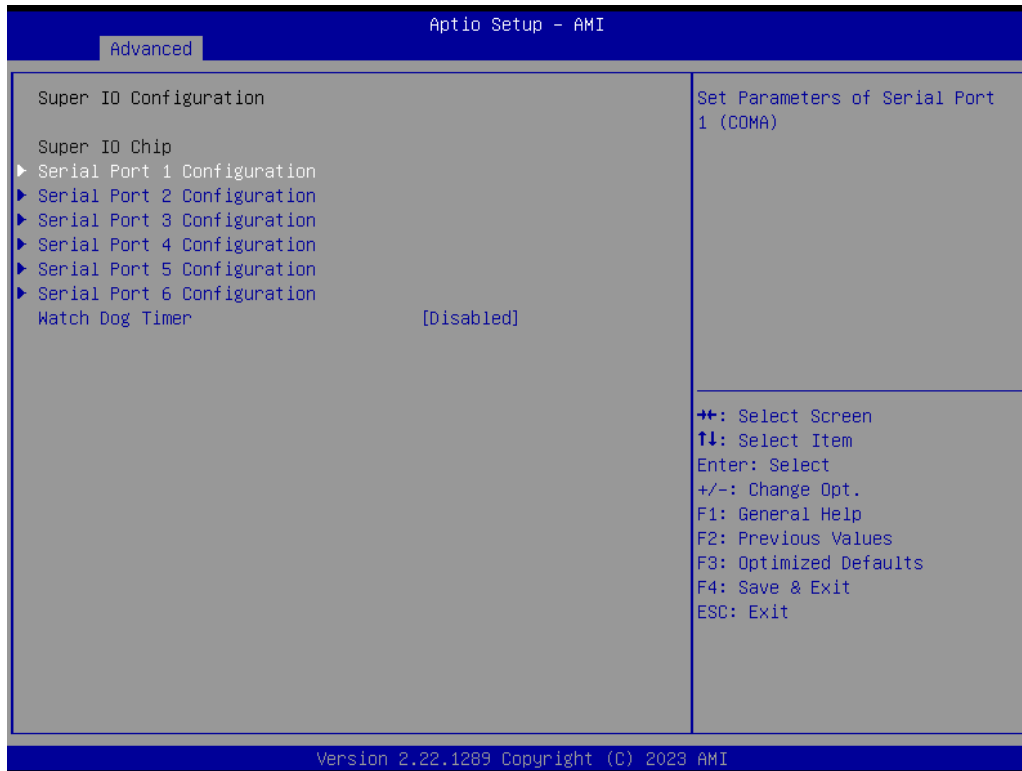

Item	Description
Serial Port 1 Configuration	Set Parameters of Serial Port 1 (COMA).
Serial Port 2 Configuration	Set Parameters of Serial Port 2 (COMB).
Serial Port 3 Configuration	Set Parameters of Serial Port 3 (COMC).
Serial Port 4 Configuration	Set Parameters of Serial Port 4 (COMD).
Serial Port 5 Configuration	Set Parameters of Serial Port 5 (COME).
Serial Port 6 Configuration	Set Parameters of Serial Port 6 (COMF).

Item	Options	Description
Watch Dog Timer	Disabled [Default], Enabled	Enabled or Disabled Watch Dog Timer function.
Watch Dog Timer Count Mode	Second Mode[Default], Minute Mode	Select Second Mode or Minute Mode.
Watch Dog Timer Time out Value	20~255(Second)[Default], 1~255(Minute)	Watch Dog Timer Time out Value.

Serial Port 1 Configuration

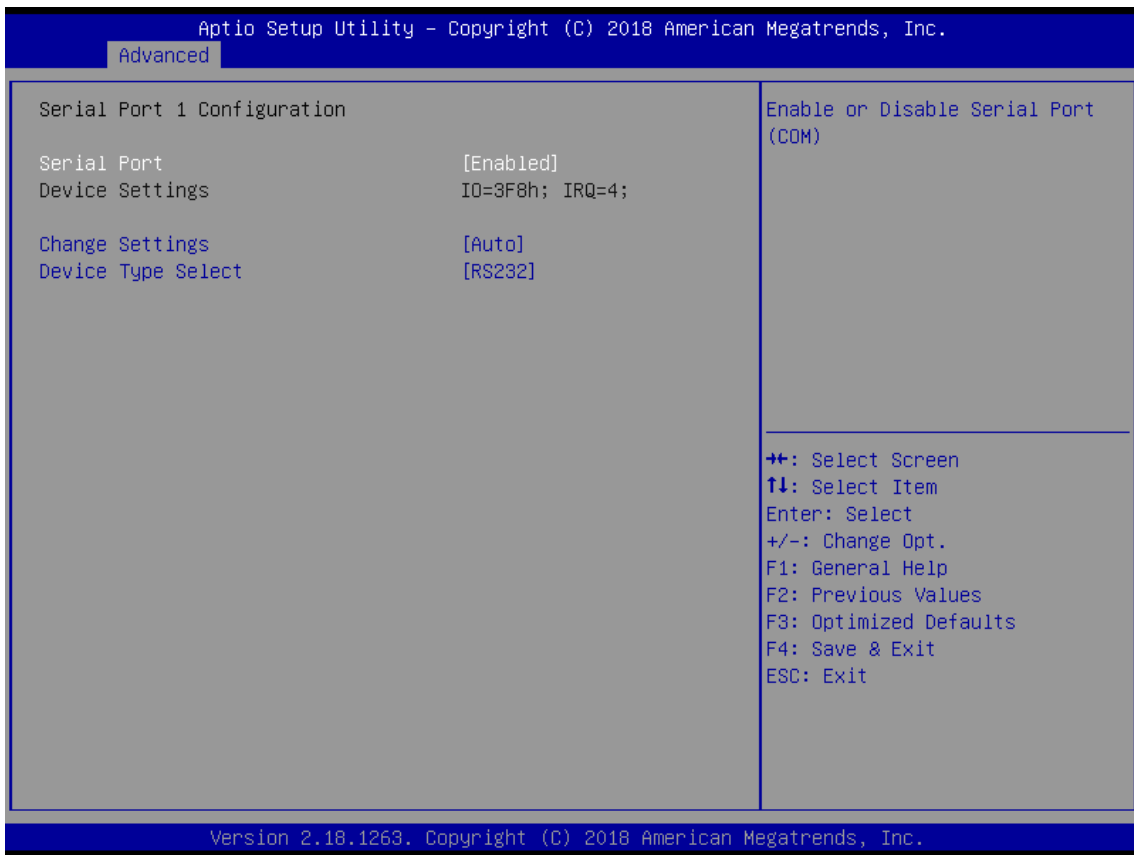

Item	Options	Description
Serial Port	Disabled, Enabled[Default]	Enable or Disable Serial Port (COM).
Change Settings	Auto[Default], IO=3F8h; IRQ=4; , IO=3F8h; IRQ=3,4,5,6,7,9,10,11,12; , IO=2F8h; IRQ=3,4,5,6,7,9,10,11,12;; IO=3E8h; IRQ=3,4,5,6,7,9,10,11,12;; IO=2E8h; IRQ=3,4,5,6,7,9,10,11,12;	This item allows you to change the address & IRQ settings of the specified serial port.
Device Type Select	UART 232[Default], UART 422, UART 485	Set the Serial Port to RS232 & RS422 & RS485
RS-485 Auto Flow Function	Disabled, Enabled[Default]	Enabled/Disabled RS485 Autoflow Function

Serial Port 2 Configuration

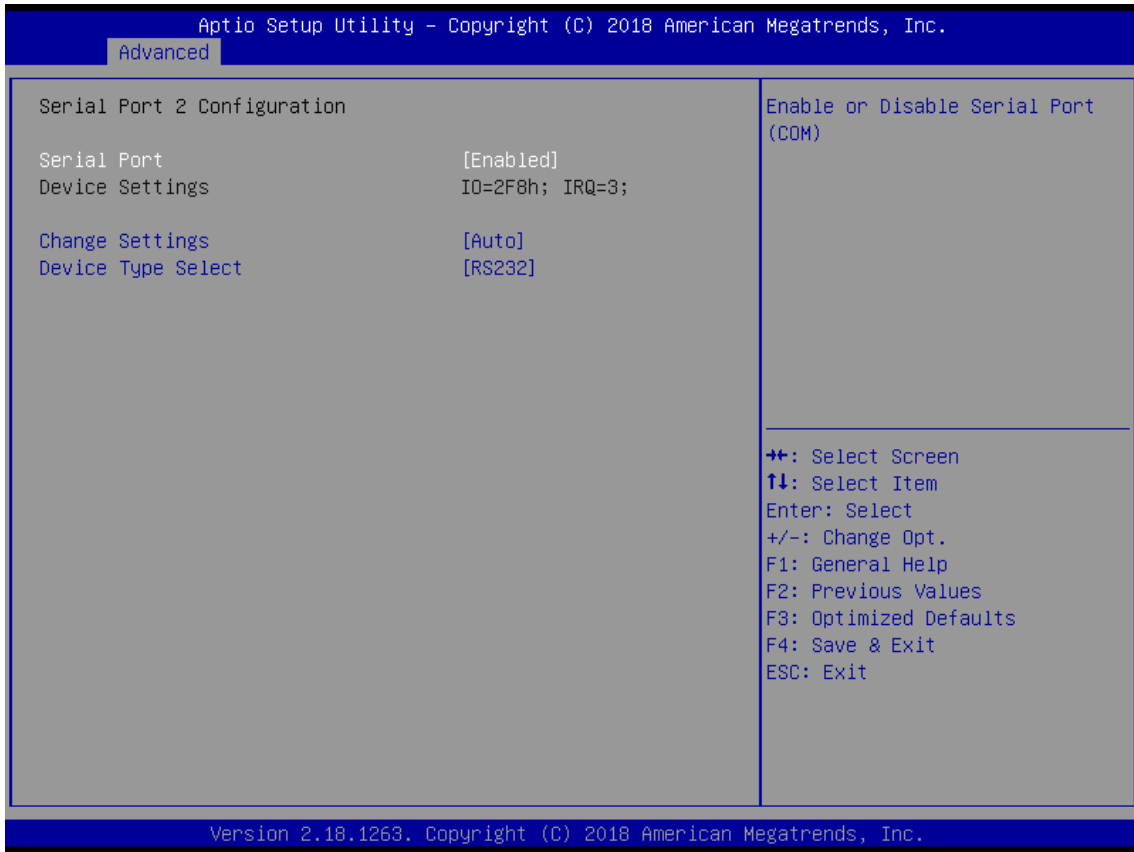

Item	Options	Description
Serial Port	Disabled, Enabled[Default]	Enable or Disable Serial Port (COM).
Change Settings	Auto[Default], IO=2F8h; IRQ=3; , IO=3F8h; IRQ=3,4,5,6,7,9,10,11,12; , IO=2F8h; IRQ=3,4,5,6,7,9,10,11,12;; IO=3E8h; IRQ=3,4,5,6,7,9,10,11,12;; IO=2E8h; IRQ=3,4,5,6,7,9,10,11,12;	This item allows you to change the address & IRQ settings of the specified serial port.
Device Type Select	UART 232[Default], UART 422, UART 485	Set the Serial Port to RS232 & RS422 & RS485
RS-485 Auto Flow Function	Disabled, Enabled[Default]	Enabled/Disabled RS485 Autoflow Function

Serial Port 3 Configuration

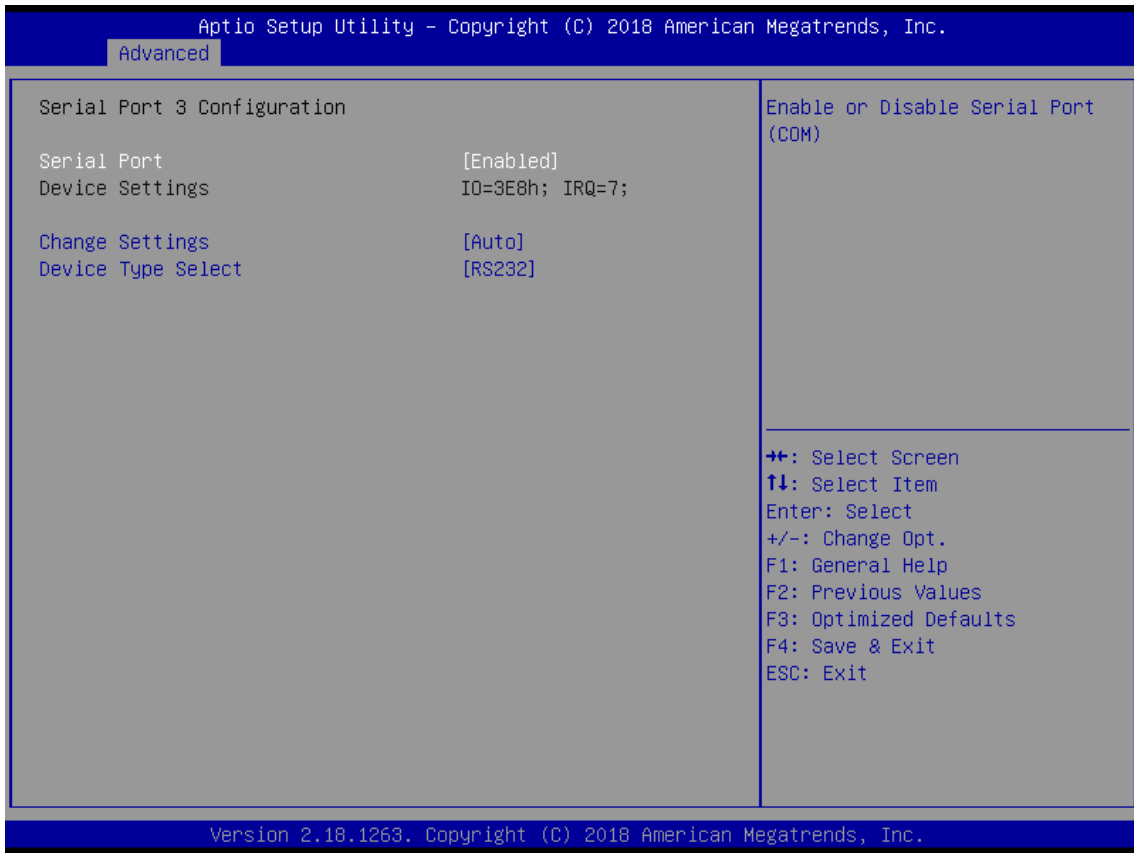

Item	Options	Description
Serial Port	Disabled, Enabled[Default]	Enable or Disable Serial Port (COM).
Change Settings	Auto[Default], IO=3E8h; IRQ=7; , IO=3E8h; IRQ=3,4,5,6,7,9,10,11,12; , IO=2E8h; IRQ=3,4,5,6,7,9,10,11,12;; IO=2F0h; IRQ=3,4,5,6,7,9,10,11,12;; IO=2E0h; IRQ=3,4,5,6,7,9,10,11,12;	This item allows you to change the address & IRQ settings of the specified serial port.
Device Type Select	UART 232[Default], UART 422, UART 485	Set the Serial Port to RS232 & RS422 & RS485
RS-485 Auto Flow Function	Disabled, Enabled[Default]	Enabled/Disabled RS485 Autoflow Function

Serial Port 4 Configuration

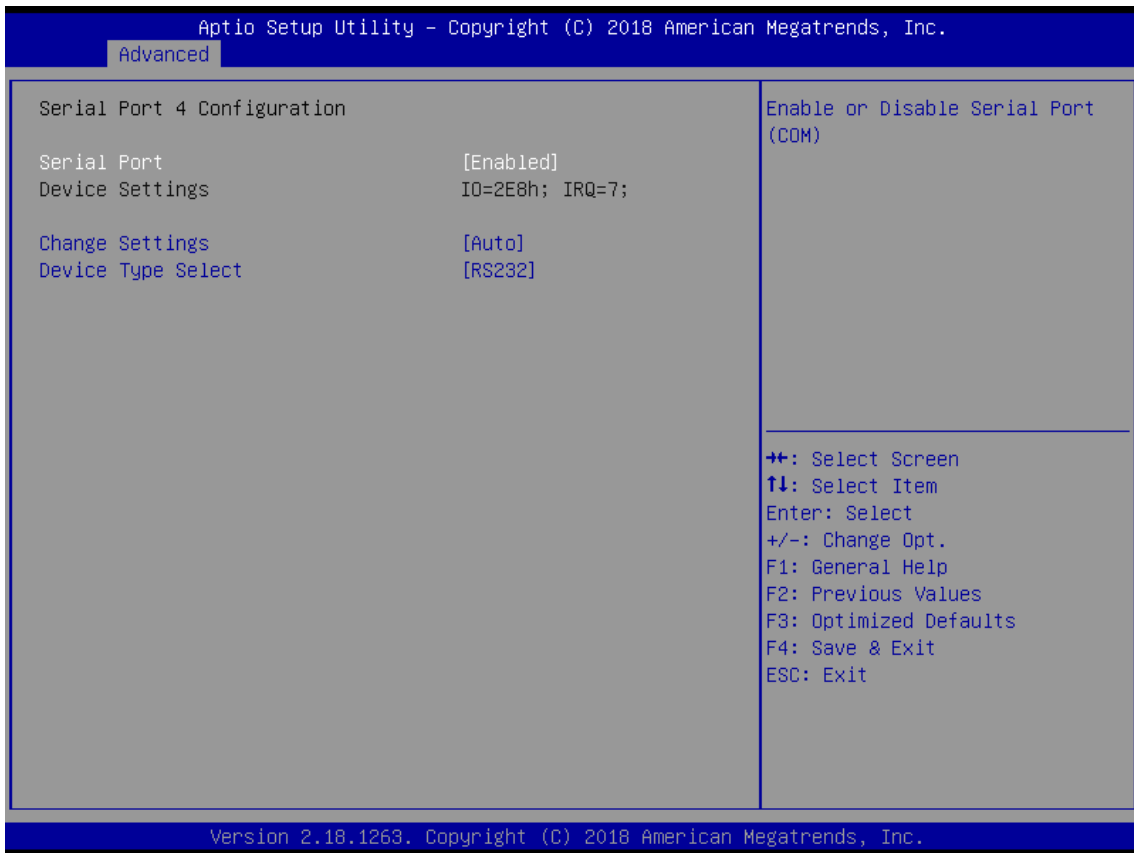

Item	Options	Description
Serial Port	Disabled, Enabled[Default]	Enable or Disable Serial Port (COM).
Change Settings	Auto[Default], IO=2E8h; IRQ=7; , IO=3E8h; IRQ=3,4,5,6,7,9,10,11,12; , IO=2E8h; IRQ=3,4,5,6,7,9,10,11,12;; IO=2F0h; IRQ=3,4,5,6,7,9,10,11,12;; IO=2E0h; IRQ=3,4,5,6,7,9,10,11,12;	This item allows you to change the address & IRQ settings of the specified serial port.
Device Type Select	UART 232[Default], UART 422, UART 485	Set the Serial Port to RS232 & RS422 & RS485
RS-485 Auto Flow Function	Disabled, Enabled[Default]	Enabled/Disabled RS485 Autoflow Function

Serial Port 5 Configuration

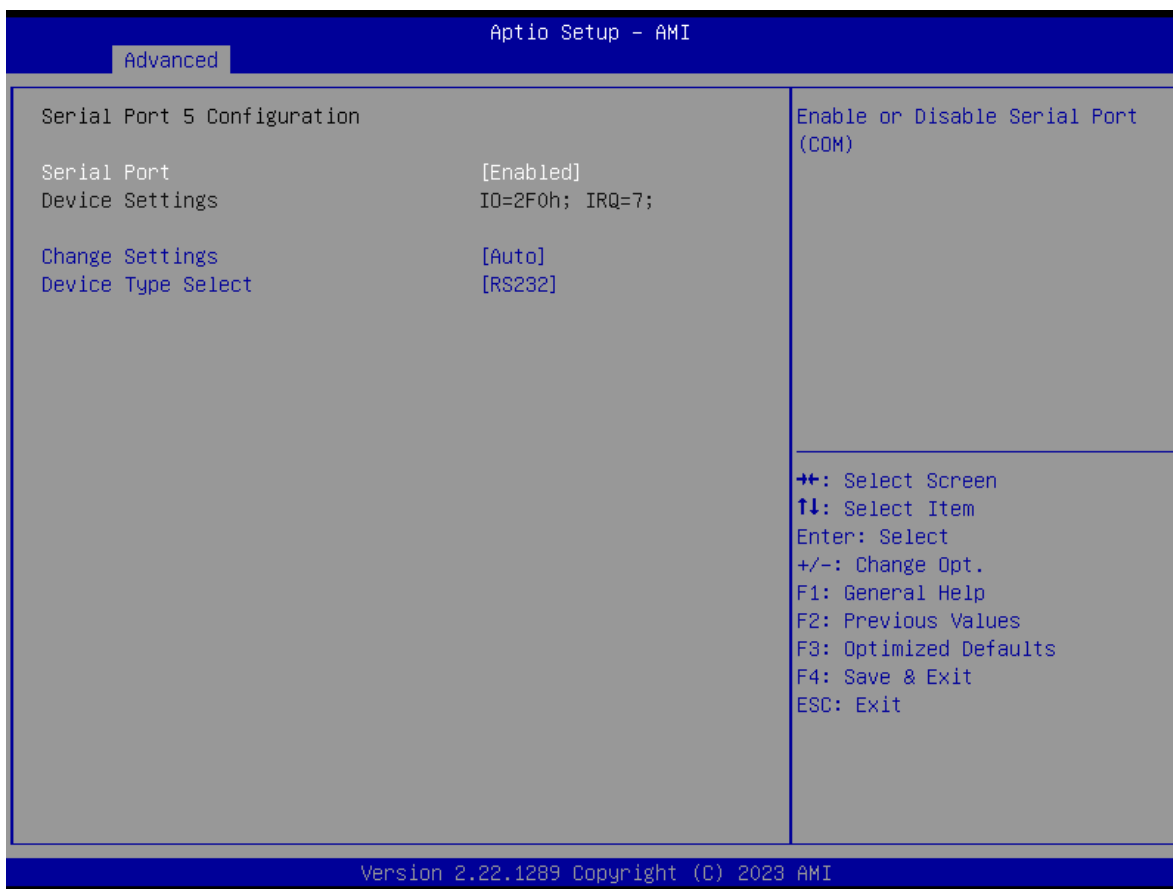

Item	Options	Description
Serial Port	Disabled, Enabled[Default]	Enable or Disable Serial Port (COM).
Change Settings	Auto[Default], IO=2F0h; IRQ=7; , IO=3E8h; IRQ=3,4,5,6,7,9,10,11,12; , IO=3E8h; IRQ=3,4,5,6,7,9,10,11,12;; IO=2F0h; IRQ=3,4,5,6,7,9,10,11,12;; IO=2E0h; IRQ=3,4,5,6,7,9,10,11,12;	This item allows you to change the address & IRQ settings of the specified serial port.
Device Type Select	UART 232[Default], UART 422, UART 485	Set the Serial Port to RS232 & RS422 & RS485
RS-485 Auto Flow Function	Disabled, Enabled[Default]	Enabled/Disabled RS485 Autoflow Function

Serial Port 6 Configuration

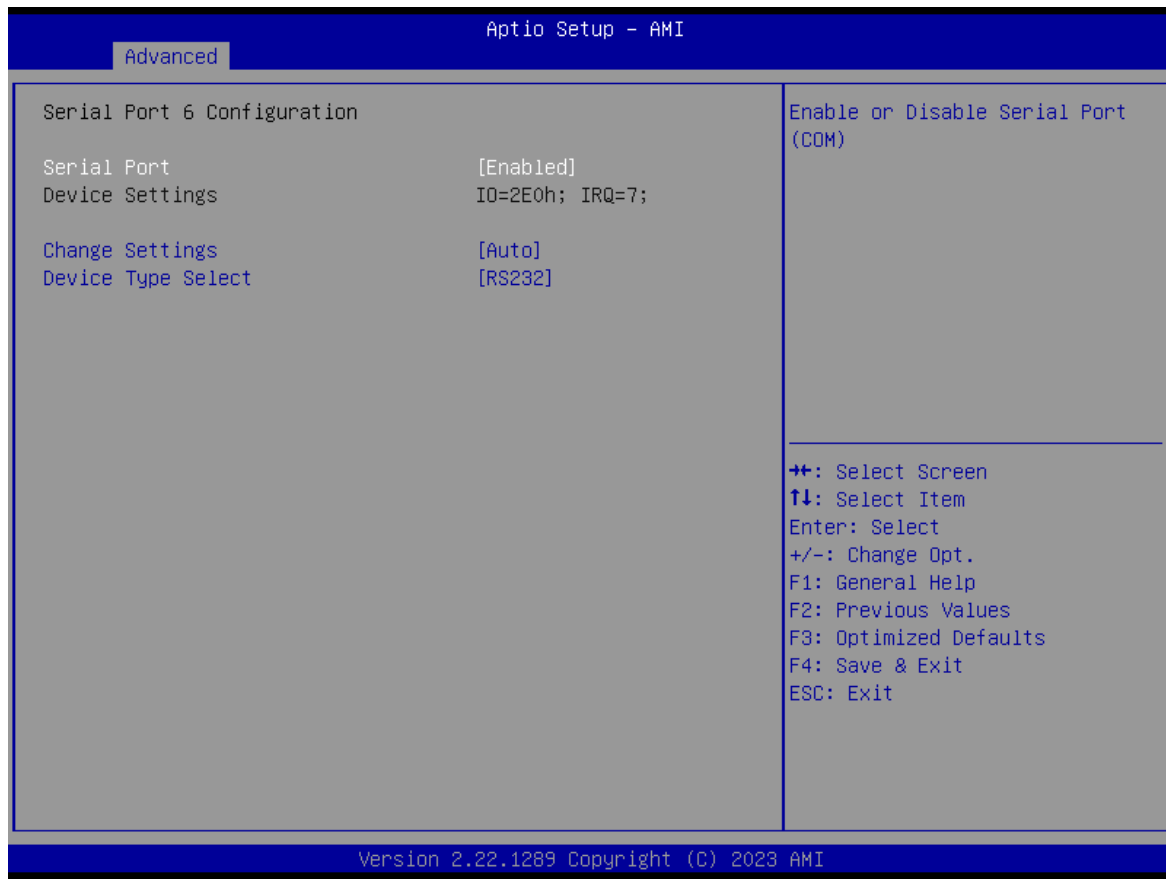

Item	Options	Description
Serial Port	Disabled, Enabled[Default]	Enable or Disable Serial Port (COM).
Change Settings	Auto[Default], IO=2E0h; IRQ=7; , IO=3E8h; IRQ=3,4,5,6,7,9,10,11,12; , IO=3E8h; IRQ=3,4,5,6,7,9,10,11,12;, IO=2F0h; IRQ=3,4,5,6,7,9,10,11,12;, IO=2E0h; IRQ=3,4,5,6,7,9,10,11,12;	This item allows you to change the address & IRQ settings of the specified serial port.
Device Type Select	UART 232[Default], UART 422, UART 485	Set the Serial Port to RS232 & RS422 & RS485
RS-485 Auto Flow Function	Disabled, Enabled[Default]	Enabled/Disabled RS485 Autoflow Function
RS-422/RS-485 Terminal Function	Disabled, Enabled[Default]	RS-422/RS-485 Terminal Function

4.3.9 Hardware Monitor

These items display the current status of all monitored hardware devices/ components such as voltages and temperatures.

The screenshot shows the 'Aptio Setup - AMI' interface with the 'Advanced' tab selected. The 'Smart Fan Mode Configuration' section is expanded, showing the following settings:

- Smart Fan Function: [Enabled]
- CPU Temperature(Tcase): +71 C
- System Temperature: +34 C
- FanSIO Speed: 2115 RPM
- MCU Temperature: +34 C
- MCU Speed: N/A
- Slot Expansion Temperature1: +30 C
- Slot Expansion Temperature2: N/A
- Slot Expansion Temperature3: N/A
- Slot Expansion Fan Speed1: N/A
- Slot Expansion Fan Speed2: N/A
- VCORE: +1.160 V
- +5V: +5.045 V
- +3V3: +3.321 V
- +12: +12.270 V

The right side of the screen displays the 'Enable or Disable Smart Fan' option and a navigation menu:

- ++: Select Screen
- ↑↓: Select Item
- Enter: Select
- +/-: Change Opt.
- F1: General Help
- F2: Previous Values
- F3: Optimized Defaults
- F4: Save & Exit
- ESC: Exit

At the bottom of the screen, it says 'Version 2.22.1289 Copyright (C) 2023 AMI'.

Item	Options	Description
Smart Fan Function	Disabled[Default], Enabled	Enabled or Disable Smart Fan

Smart Fan Mode Configuration

Aptio Setup - AMI

Advanced

Smart Fan Mode Configuration

FanSIO SmartFan Control	[Auto Duty-Cycle Mode]	Smart Fan Mode Select
Temperature 1	30	
Temperature 2	45	
Temperature 3	60	
Temperature 4	70	
Duty Cycle 1	40	
Duty Cycle 2	60	
Duty Cycle 3	80	
Duty Cycle 4	100	
Fan(MCU) SmartFan Control	[Auto Duty-Cycle Mode]	
Temperature Low	20	++: Select Screen
Temperature High	60	↑↓: Select Item
Duty Cycle 1	30	Enter: Select
Duty Cycle 2	40	+/-: Change Opt.
Duty Cycle 3	50	F1: General Help
Duty Cycle 4	70	F2: Previous Values
Duty Cycle 5	80	F3: Optimized Defaults
Duty Cycle 6	100	F4: Save & Exit
Fan(Slot) SmartFan Control	[Auto Duty-Cycle Mode]	ESC: Exit
Temperature 1	34	
Temperature 2	36	

Version 2.22.1289 Copyright (C) 2023 AMI

Item	Options	Description
FanSIO SmartFan Control	Manual Mode, Auto Duty-Cycle Mode[Default],	Smart Fan Mode Select
Temperature 1~4	1~100	Auto fan speed control. Temperature 1-100
Duty Cycle 1~4	20~100	Auto fan speed control. Duty 20-100

4.3.10. Power IGN Mode

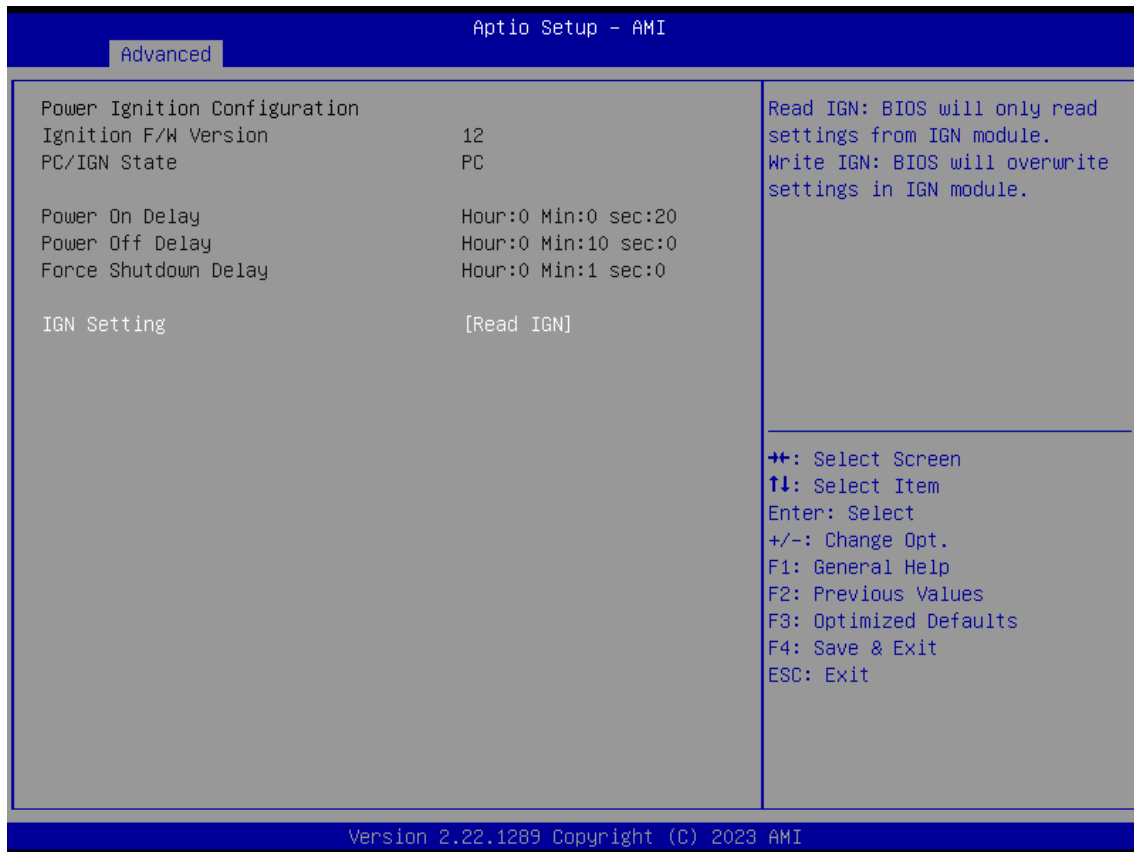

Item	Options	Description
IGN Setting	Read mode[Default] Write IGN	Read IGN: BIOS will only read settings from IGN module. Write IGN: BIOS will overwrite settings in IGN module.
Power On Delay	10 Sec[Default] 20 Sec 30 Sec 40 Sec 50 Sec 1 Min Manual Mode	Power On Delay Select
Manual Mode	10 Sec[Default]	10~60 Sec
Power Off Delay	3 Sec[Default], 1 Min, 5 Min, 10 Min, 30 Min, 1 Hour, 2 Hour, Manual Mode	Power Off Delay Select
Manual Mode	3 Sec[Default]	3~7200 Sec

4.3.11. Wake system from S5



Item	Options	Description
Wake system from S5	Disabled[Default], Fixed Time, Dynamic Time, ByPass	Enable or disable System wake on alarm event. Select FixedTime, system will wake on the hr::min::sec specified. Select DynamicTime, System will wake on the current time + Increase minute(s), Bypass: BIOS will not control RTC wake function during system shutdown
Wake up day	0[Default]	Date (of month) Alarm (0 is mean daily or you can setup a specific month)
Wake up hour	0[Default]	select 0-23 For example enter 3 for 3am and 15 for 3pm
Wake up minute	0[Default]	select 0-59 for Minute
Wake up second	0[Default]	select 0-59 for Second
Wake up minute increase	0[Default]	1 - 5

4.3.12 Serial Port Console Redirection



Item	Options	Description
Console Redirection	Disabled[Default], Enabled	These items allows you to enable or disable COM1 console redirection

4.3.13 USB Configuration

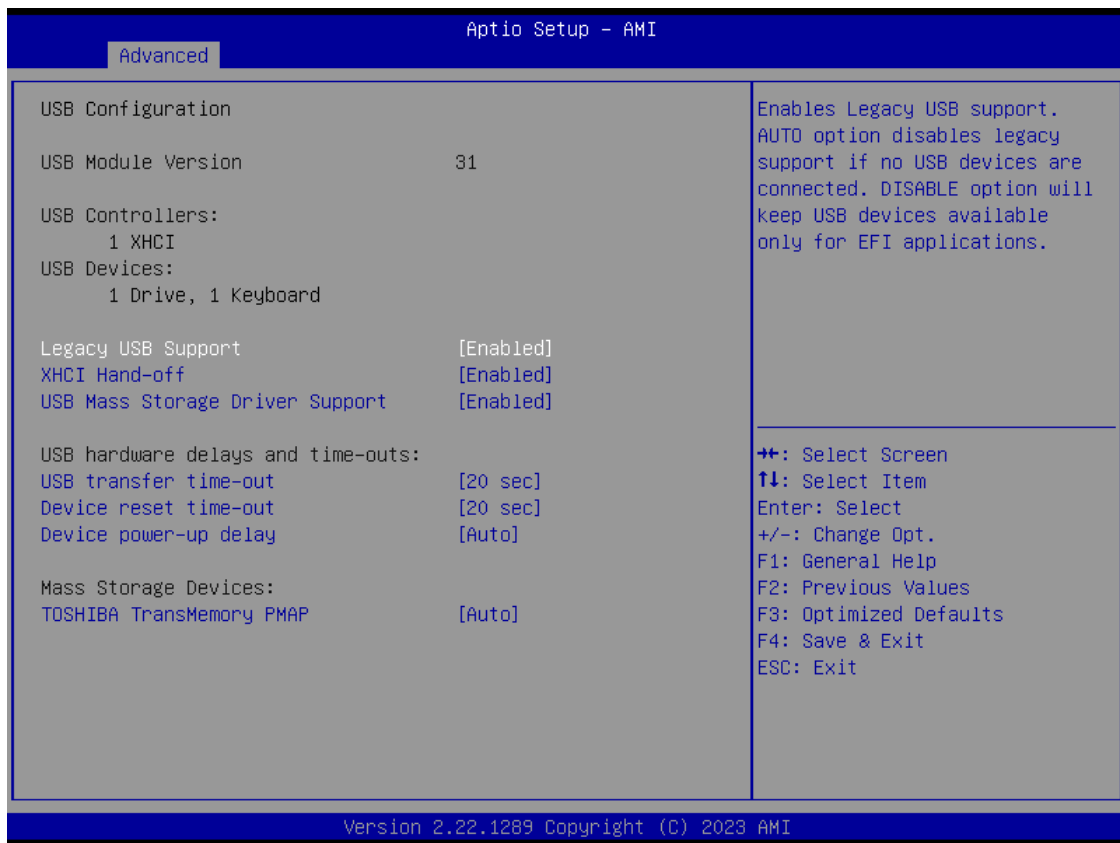

Item	Options	Description
Legacy USB Support	Enabled[Default] Disabled Auto	Enables Legacy USB support. AUTO option disables legacy support if no USB devices are connected. DISABLE option will keep USB devices available only for EFI applications.
XHCI Hand-off	Enabled[Default] Disabled	This is a workaround for OS without XHCI hand-off support. The XHCI ownership change should be claimed by XHCI driver.
USB Mass Storage Driver Support	Enabled[Default] Disabled	Enable/Disable USB Mass Storage Driver Support.
USB transfer time-out	1 sec , 5 sec , 10 sec , 20 sec[Default]	The time-out value for Control, Bulk, and Interrupt transfers.
Device reset time-out	10 sec , 20 sec[Default] , 30 sec, 40 sec	USB mass storage device Start Unit command time-out.
Device power-up delay	Auto[Default] Manual	Maximum time the device will take before it properly reports itself to the Host Controller. 'Auto' uses default value: for a Root port it is 100ms, for a Hub port the delay is taken from Hub descriptor.

4.3.14 Network Stack Configuration

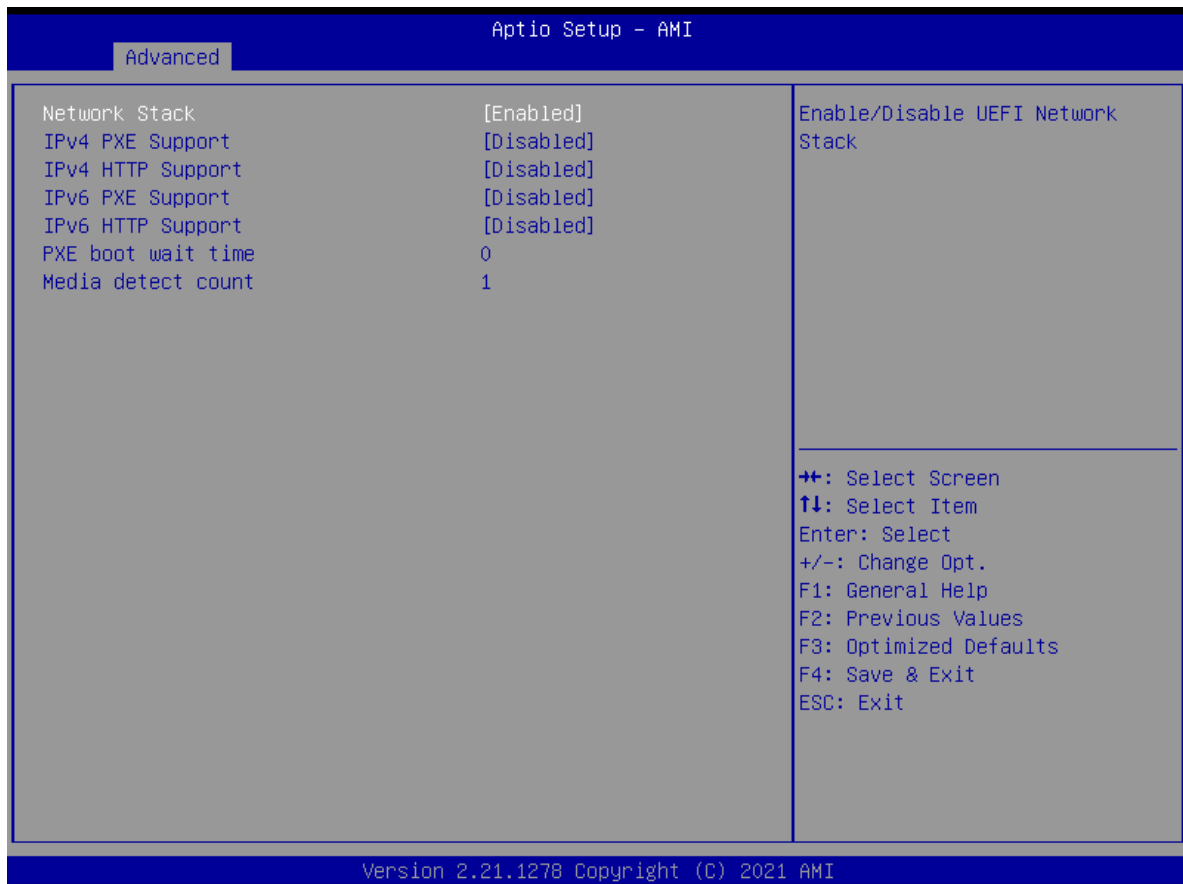

Item	Options	Description
Network Stack	Disabled[Default] , Enabled	Enable/Disable UEFI Network Stack.
IPv4 PXE Support	Disabled[Default] , Enabled	Enable/Disable IPv4 PXE boot support. If disabled, IPv4 PXE boot support will not be available.
IPv4 HTTP Support	Disabled[Default] , Enabled	Enable/Disable IPv4 HTTP boot support. If disabled, IPv4 HTTP boot support will not be available.
IPv6 PXE Support	Disabled[Default] , Enabled	Enable/Disable IPv4 PXE boot support. If disabled, IPv6 PXE boot support will not be available.
IPv6 HTTP Support	Disabled[Default] , Enabled	Enable/Disable IPv6 HTTP boot support. If disabled, IPv6 HTTP boot support will not be available.
PXE boot wait time	0[Default]	Wait time in seconds to press ESC key to abort the PXE boot. Use either +/- or numeric keys to set the value.
Media detect count	1[Default]	Number of times the presence of media will be checked. Use either +/- or numeric keys to set the value.

4.3.15 CSM Configuration

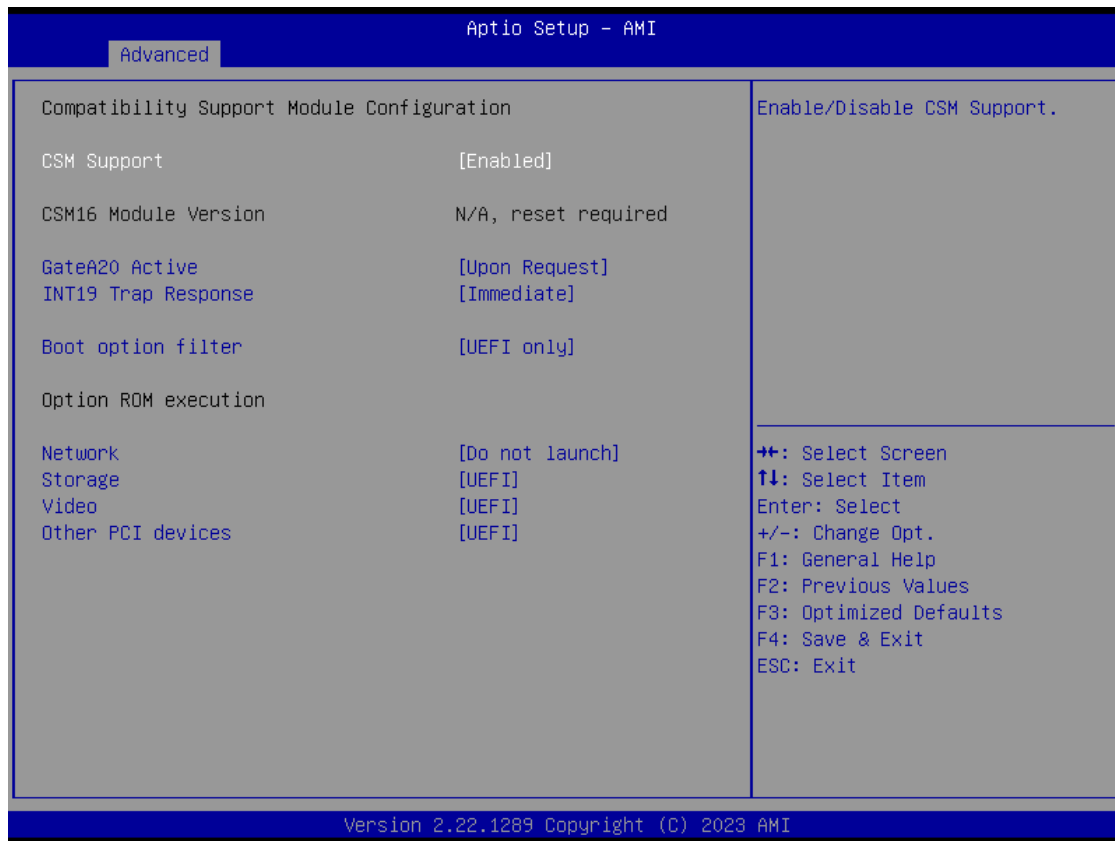

Item	Options	Description
CSM Support	Disabled[Default] , Enabled	This item allows users to enable or disable for "CSM Support".
GateA20 Active	Upon Request[Default] , Always	This item allows users to set Upon Request or Always for "GateA20 Active".
INT19 Trap Response	Immediate[Default] , Immediate	This item allows users to set the BIOS reaction to INT19 trapping by Option ROM: "Immediate" - execute the trap right away; "postponed" - execute the trap during legacy boot.
Boot option filter	UEFI and Legacy, Legacy only, UEFI only[Default]	This item allows users to select which type of operating system to boot by option. This item is configurable only when CSM Support is set to Enabled.
Network PXE	Do not launch[Default] , UEFI, Legacy	Controls the execution of UEFI and Legacy Video OpROM.
Storage	Do not launch, UEFI[Default] , Legacy	Controls the execution of UEFI and Legacy Storage OpROM.
Other PCI devices	Do not launch, UEFI[Default] , Legacy	Determines OpROM execution policy for devices other than Network, Storage, or Video.

4.3.16 NVMe Configuration



4.4 Chipset

This section allows you to configure and improve your system and allows you to set up some system features according to your preference.

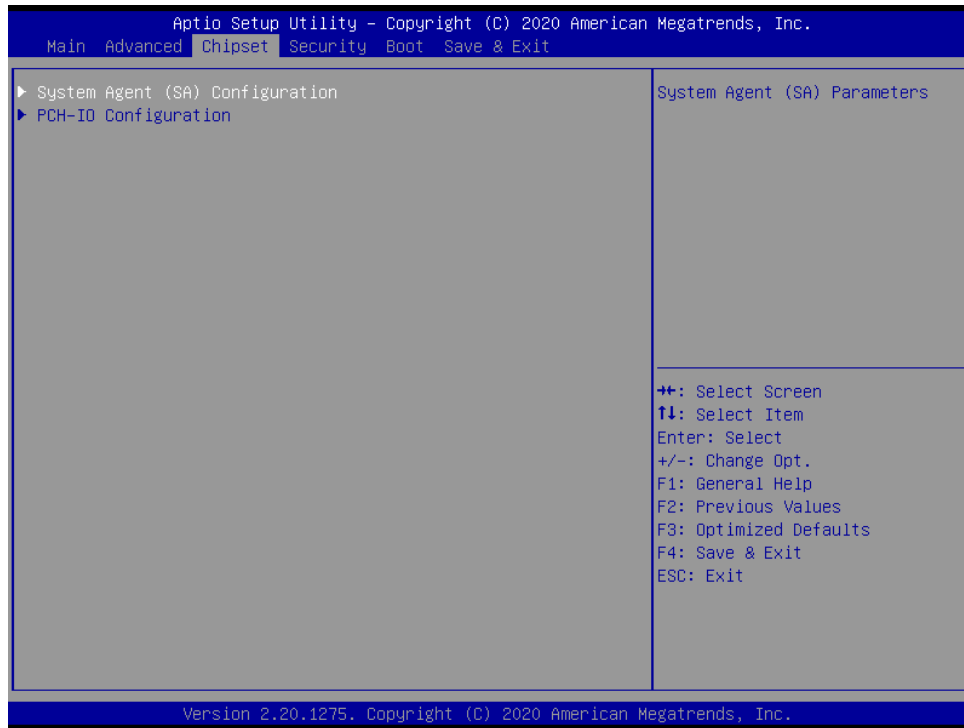

4.4.1 System Agent (SA) Configuration



Item	Options	Description
Above 4GB MMIO BIOS assignment	Enabled, Disabled[Default]	Enable/Disable above 4GB MemoryMappedIO BIOS assignment This is enabled automatically when Aperture Size is set to 2048MB.

■ Memory Configuration



Item	Options	Description
Max TOLUD	Dynamic[Default], 1GB, 1.25GB, 1.5 GB, 1.75 GB, 2 GB, 2.25 GB, 2.5 GB, 2.75 GB, 3 GB, 3.25 GB, 3.5 GB	Maximum Value of TOLUD. Dynamic assignment would adjust TOLUD automatically based on largest MMIO length of installed graphic controller

■ Graphic Configuration

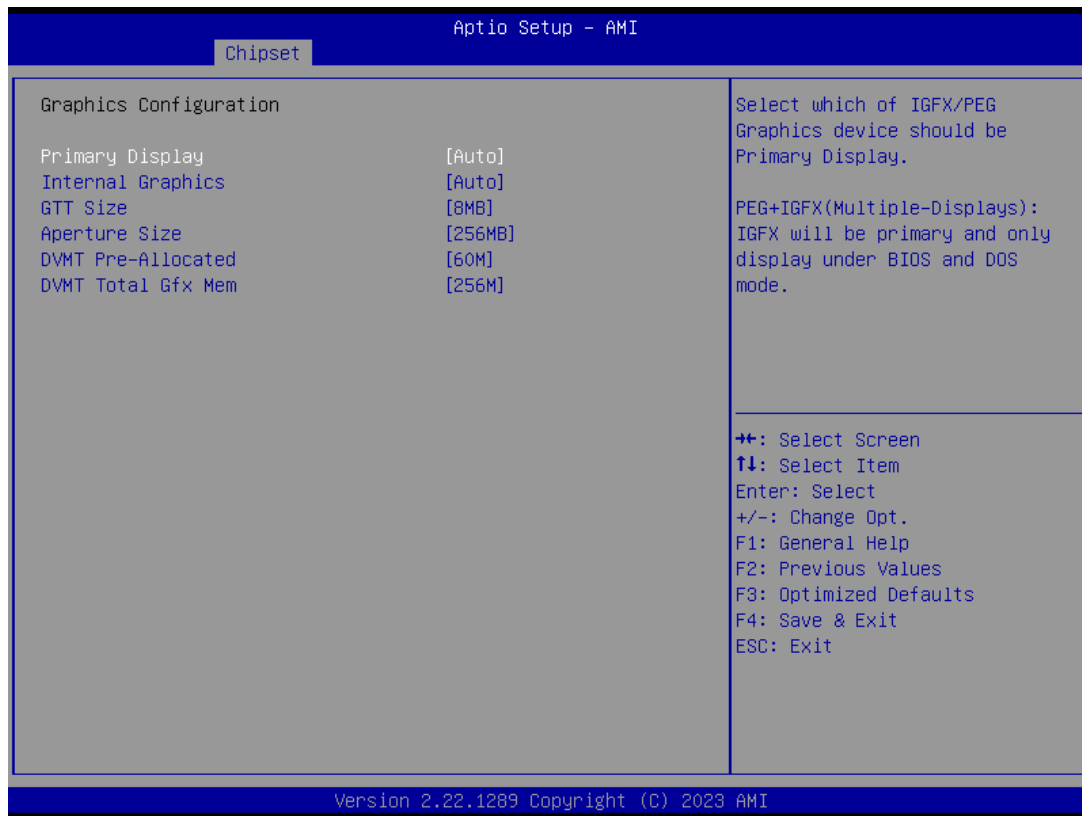

Item	Options	Description
Primary Display	Auto[Default] , PEG + IGFX	Select which of IGFX/PEG Graphics device should be Primary Display. PEG+IGFX(Multiple-Displays): IGFX will be primary and only display under BIOS and DOS mode.
Internal Graphics	Auto[Default] , Disabled, Enabled	Keep IGFX enabled based on the setup options.
GTT Size	2MB, 4MB, 8MB[Default]	Select the GTT Size .
Aperture Size	128MB, 256MB[Default] , 512MB, 1024MB	Select the Aperture Size. Note : Above 4GB MMIO BIOS assignment is automatically enabled when selecting 2048MB aperture. To use this feature, please disable CSM Support.
DVMT Pre-Allocated	32M,64M,4M,8M, 12M,16M, 20M, 24M, 28M,32M/F7, 36M, 40M,44M, 48M,52M,56M, 60M[Default]	Select DVMT 5.0 Pre-Allocated (Fixed) Graphics Memory size used by the Internal Graphics Device.
DVMT Total Gfx Mem	128M, 256M[Default] , MAX	Select DVMT5.0 Total Graphic Memory size used by the Internal Graphics Device.

■ VMD Configuration



Item	Options	Description
Enable VMD controller	Enabled[Default], Disabled	Enable/Disable to VMD controller

■ PCI Express Configuration



■ PCI Express Configuration



Item	Options	Description
PCI Express Root Port 1~3	Disabled, Enabled[Default] ,	Control the PCI Express Root Port.
ASPM	Disabled[Default] , L0s, L1, L0sL1	Set the ASPM Level.
PCIe Speed	Aut0[Default] , Gen1, Gen2, Gen3, Gen4, Gen5,	Configure PCIe Speed

4.4.2 PCH-IO Configuration

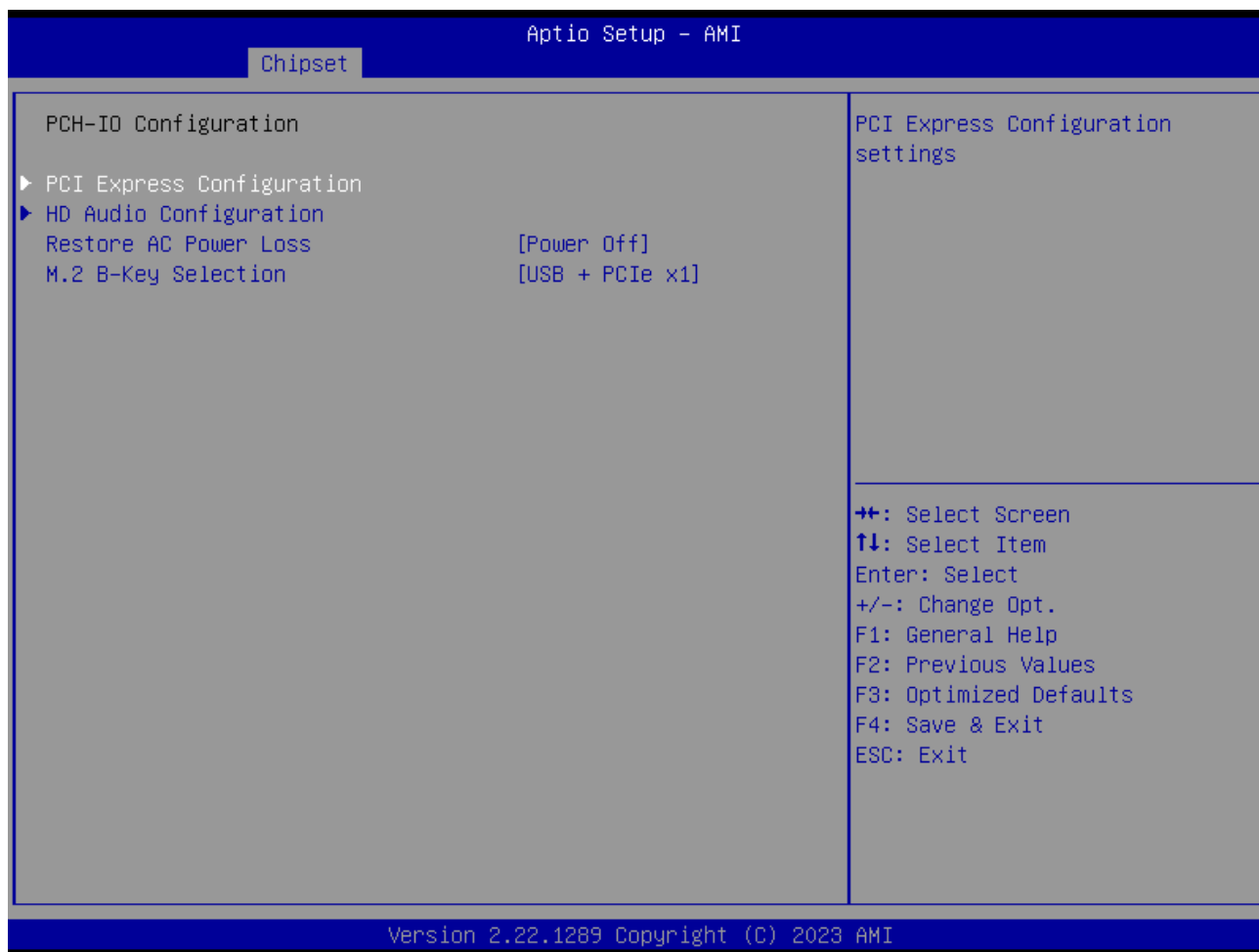

Item	Options	Description
Restore AC Power Loss	Power On, Power Off [Default] , Lase State	Specify what state to go to when power is re-applied after a power failure (G3 state).
M.2 B-Key Selection	USB + PCIe x1 [Default] , PCIe x2	Selects M.2 B-KEY function: PCIe x2 or USB + PCIe x1.

■ PCI Express Configuration

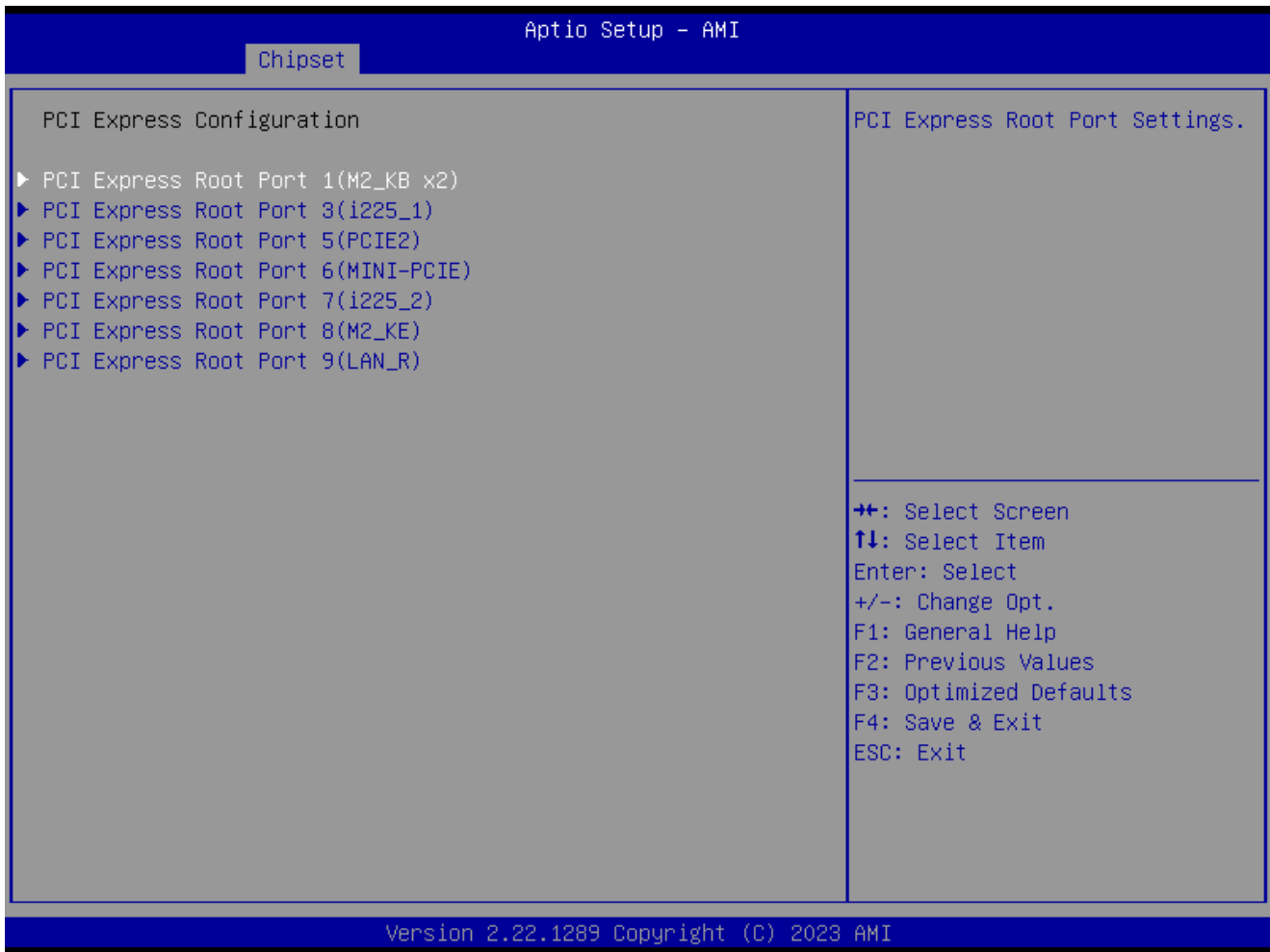

■ PCI Express Root Port 1 /3 /5 /6 /7 /8 /9

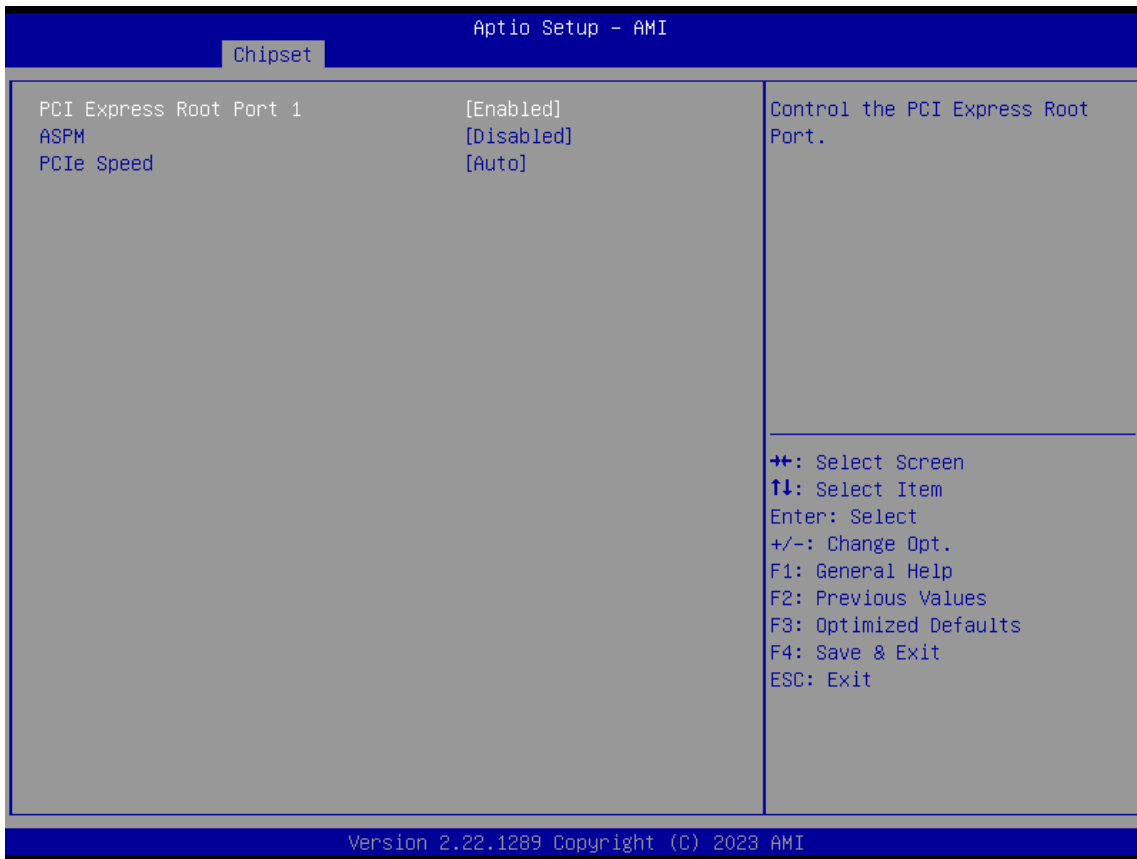

Item	Options	Description
PCI Express Root Port 1 /3 /5 /6 /7 /8 /9	Disabled, Enabled [Default]	Control the PCI Express Root Port.
ASPM	Disabled [Default] , L1, Auto	Set the ASPM Level.
PCIe Speed	Auto [Default] , Gen1, Gen2, Gen3, Gen4	Configure PCIe speed.

■ HD Audio Configuration

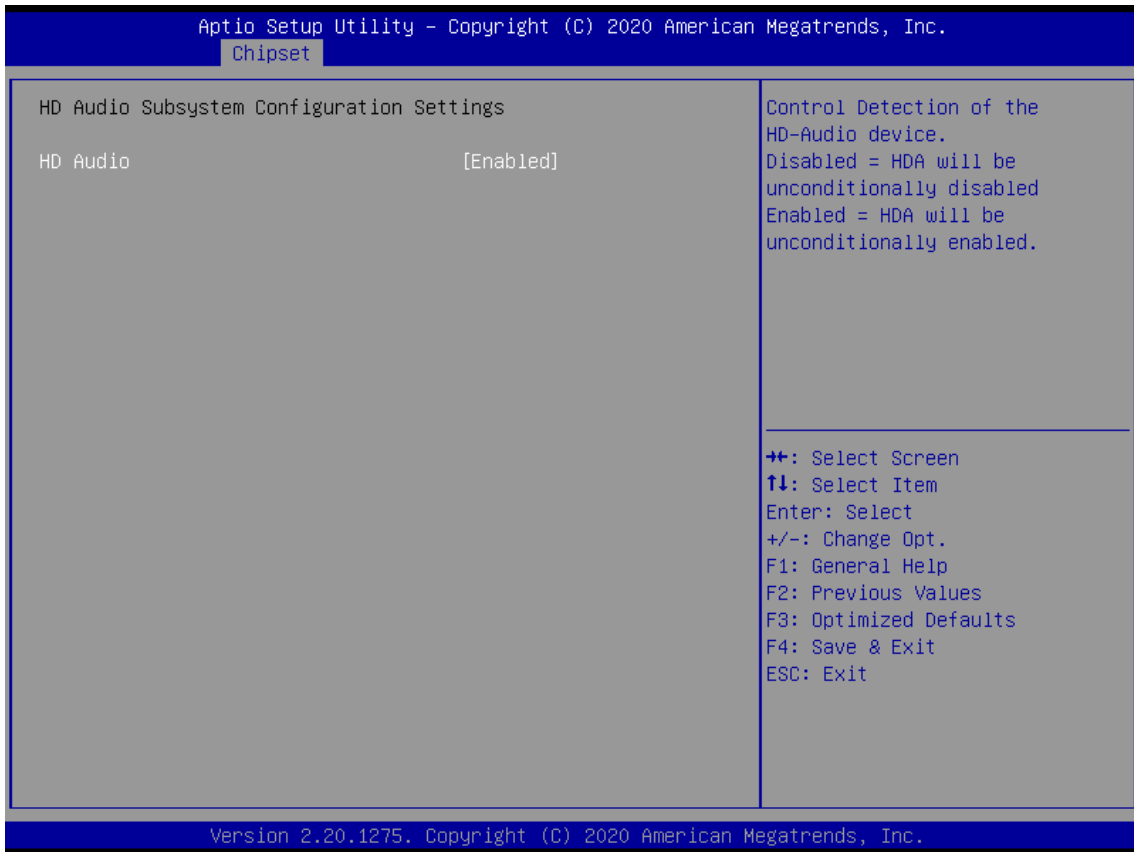

Item	Options	Description
HD Audio	Disabled, Enabled [Default]	Control Detection of the HD-Audio device. Disabled = HDA will be unconditionally disabled Enabled = HDA will be unconditionally enabled.

4.5 Security

Security menu allow users to change administrator password and user password settings.

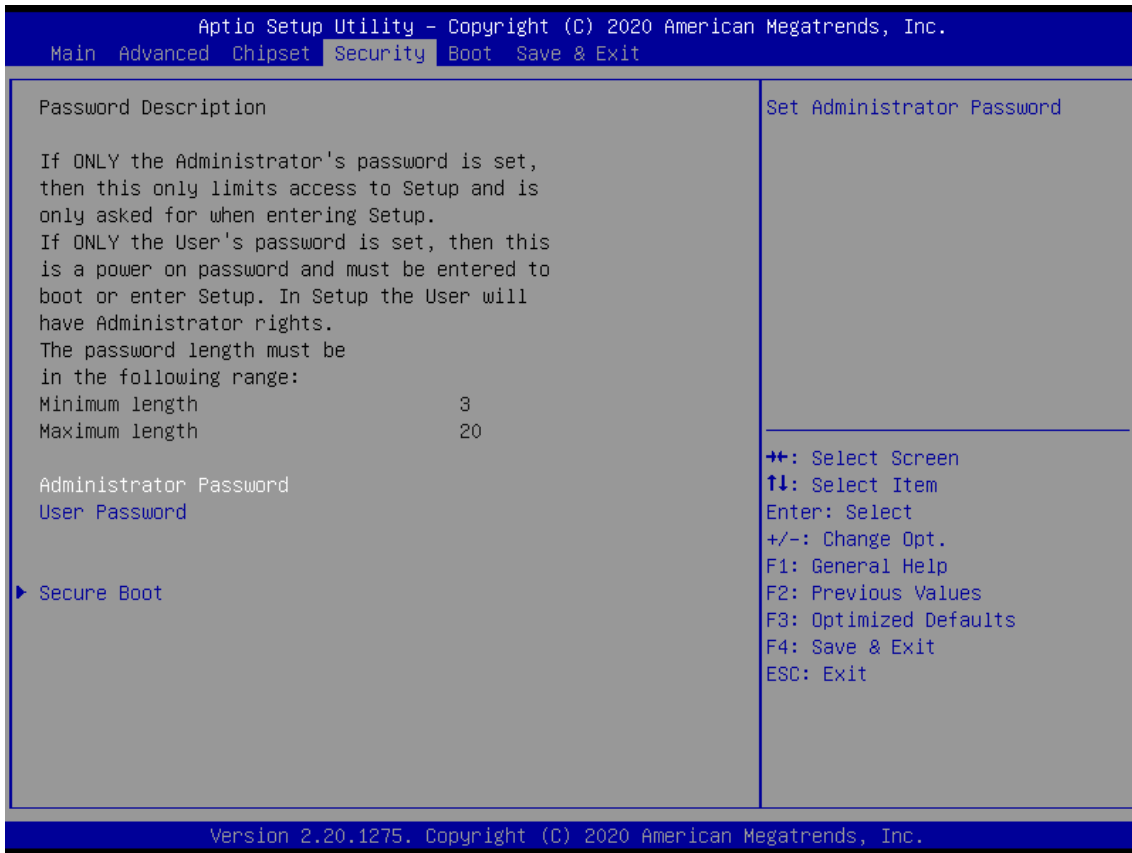

■ Administrator Password

This item allows you to set Administrator Password.

■ User Password

This item allows you to set User Password.

■ Security Boot



Item	Options	Description
Secure Boot	Disabled [Default] , Enabled	Secure Boot feature is Active if Secure Boot is Enabled, Platform Key(PK) is enrolled and the System is in User mode. The mode change requires platform reset
Secure Boot Mode	Standard, Custom [Default]	Secure Boot mode options: Standard or Custom. In Custom mode, Secure Boot Policy variables can be configured by a physically present user without full authentication

■ Key Management

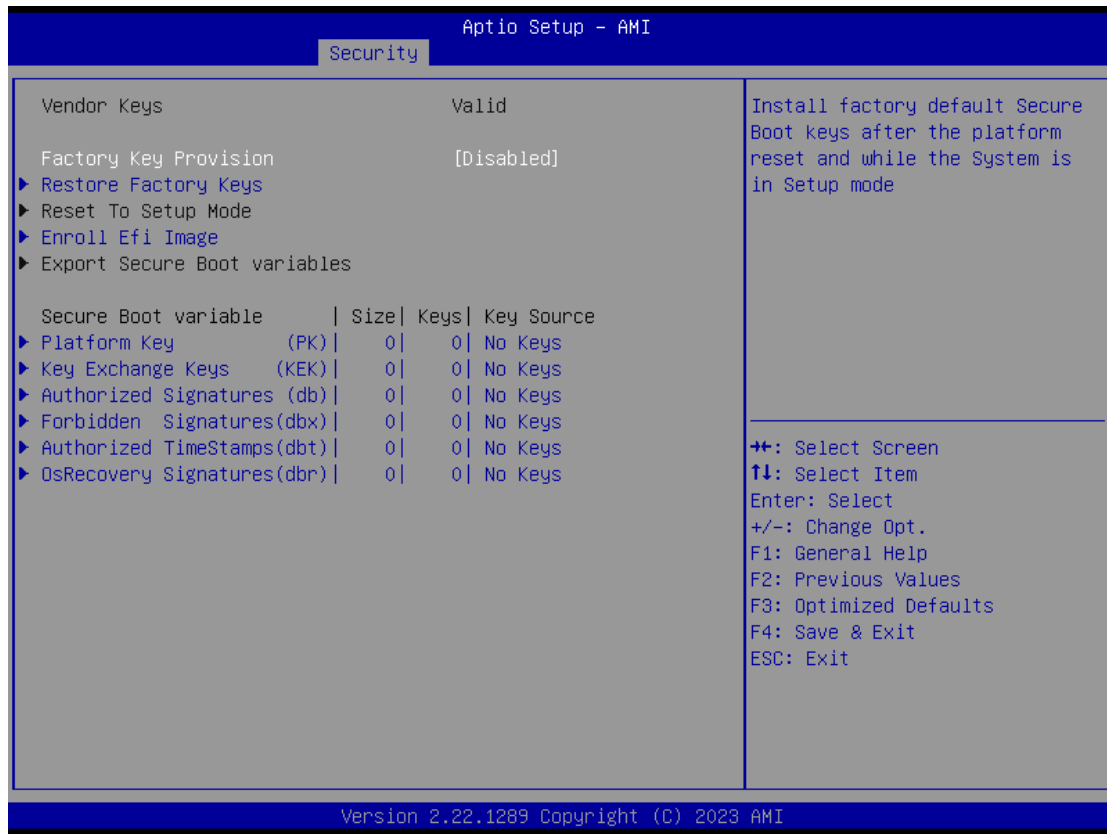

Item	Options	Description
Factory Key Provision	Disabled [Default] , Enabled	Install factory default Secure Boot keys after the platform reset and while the System is in Setup mode

4.6 Boot

This menu allows you to setup the system boot options.



Item	Options	Description
Setup Prompt Timeout	1[Default]	Number of seconds to wait for setup activation key. 65535(0xFFFF) means indefinite waiting.
Bootup NumLock State	On[Default] , Off	Select the Keyboard NumLock state.
Quiet Boot	Disabled[Default] , Enabled	Enables or disables Quiet Boot option.
Fast Boot	Disabled[Default] , Enabled	Enables/Disables boot with initialization of a minimal set of devices required to launch active boot option. Has no effect for BBS boot options.

4.7 Save & Exit

This setting allows users to configure the boot settings.

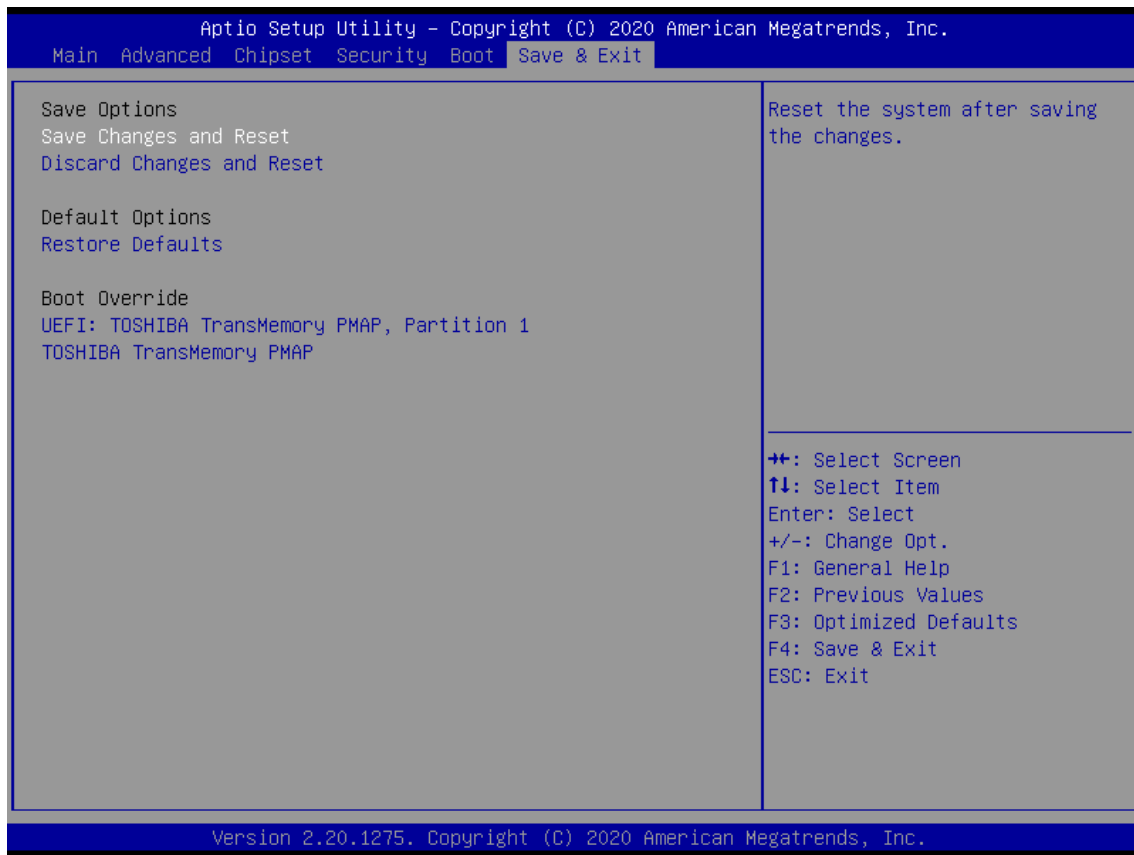

■ Save Changes and Reset

This item allows user to reset the system after saving the changes. This item allows user to reset the system after saving the changes.

■ Discard Changes and Reset

This item allows user to reset the system without saving any changes.

■ Restore Defaults

Use this item to restore /load default values for all the setup options.

4.8 MEBx



Item	Options	Description
Intel(R) ME Password		MEBx Login

Appendix

WDT & GPIO

This appendix provides the sample codes of WDT (Watch Dog Timer) and GPIO (General Purpose Input/ Output).

WDT Sample Code

WDT Setting

The WDT function is provided by Fintek F81966 , and it can be accessed through IO Address. The configuration on the VCO-6000 –RPL is described as below.

Psuedo Code

```
// IO Address 0xA16 is time value(second)
// IO Address 0xA15 is WDT enable and configuration
Example, Set 0xA16=-0x03, 0xA15=0x31, it will reset after 3 seconds
```

```
#define TimePort      0xA16
#define TimeEnablePort 0xA15
```

```
WriteByte (TimePort,0x03)
WriteByte (TimeEnablePort,0x31)
```

GPIO Sample CodeGPIO Setting

PIN#	GPIO#	Default Configuration
18	XCOM-	
17	XCOM+	
16	OUT8	DIO Output8
15	IN8	DIO Input8
14	OUT7	DIO Output7
13	IN7	DIO Input7
12	OUT6	DIO Output6
11	IN6	DIO Input6
10	OUT5	DIO Output5
9	IN5	DIO Input5
8	OUT4	DIO Output4
7	IN4	DIO Input4
6	OUT3	DIO Output3
5	IN3	DIO Input3
4	OUT2	DIO Output2
3	IN2	DIO Input2
2	OUT1	DIO Output1
1	IN1	DIO Input1

The GPIO function is provided by Nuvoton M058SSAN , and it can be accessed through Smbus/I2C port. The configuration on the VCO-6000 –RPL is described as below.

Psuedo Code

```
#define GPI_ADDR 0x02 // Define Input port Address
#define GPO_ADDR 0x01 // Define Output port Address
#define Slave_ADDR 0x80 //Slave Address = 0x80( 7-bit address)
```

```
//Set OUT1~OUT8 Value
```

Bit 7	Bit 6	Bit 5	Bit 4	Bit 3	Bit 2	Bit 1	Bit 0
OUT8	OUT7	OUT6	OUT5	OUT4	OUT3	OUT2	OUT1

```
//Set GPO to 0x55
```

```
//set IO_DO1,IO_DO3,IO_DO5,IO_DO7 to high; Set IO_DO2,IO_DO4,IO_DO6,IO_DO8 to Low
SmbusWrite (Slave_ADDR, GPO_ADDR, 0x55);
```

```
// Read In1~In8 value
```

Bit 7	Bit 6	Bit 5	Bit 4	Bit 3	Bit 2	Bit 1	Bit 0
IN8	IN7	IN6	IN5	IN4	IN3	IN2	IN1

```
Data= SmbusReads (Slave_ADDR, GPI_ADDR); //Read In1~In8 value
```

