

User Manual

MIC-770 V3

Compact Fanless System with
12th Gen Intel® Core™ i CPU
Socket (LGA 1700)

ADVANTECH

Enabling an Intelligent Planet

Copyright

The documentation and the software included with this product are copyrighted 2023 by Advantech Co., Ltd. All rights are reserved. Advantech Co., Ltd. reserves the right to make improvements in the products described in this manual at any time without notice. No part of this manual may be reproduced, copied, translated, or transmitted in any form or by any means without the prior written permission of Advantech Co., Ltd. The information provided in this manual is intended to be accurate and reliable. However, Advantech Co., Ltd. assumes no responsibility for its use, nor for any infringements of the rights of third parties that may result from its use.

Acknowledgments

AMI is a trademark of American Megatrends Inc.

IBM and PC are trademarks of International Business Machines Corporation.

Intel® Core™, Pentium® and Celeron® are trademarks of Intel® Corporation.

All other product names or trademarks are properties of their respective owners.

A Message to the Customer

Advantech Customer Service

Each and every Advantech product is built to the most exacting specifications to ensure reliable performance in the harsh and demanding conditions typical of industrial environments. Whether your new Advantech equipment is destined for the laboratory or the factory floor, you can be assured that your product will provide the reliability and ease of operation for which the name Advantech has come to be known.

Your satisfaction is our primary concern. Here is a guide to Advantech's customer services. To ensure you get the full benefit of our services, please follow the instructions below carefully.

Technical Support

We want you to get the maximum performance from your products. So if you run into technical difficulties, we are here to help. For the most frequently asked questions, you can easily find answers in your product documentation. These answers are normally a lot more detailed than the ones we can give over the phone.

So please consult this manual first. If you still cannot find the answer, gather all the information or questions that apply to your problem, and with the product close at hand, call your dealer. Our dealers are well trained and ready to give you the support you need to get the most from your Advantech products. In fact, most problems reported are minor and are able to be easily solved over the phone.

In addition, free technical support is available from Advantech engineers every business day. We are always ready to give advice on application requirements or specific information on the installation and operation of any of our products.

Part No.
Printed in China

Edition 1
June 2023

Product Warranty (2 years)

Advantech warrants the original purchaser that each of its products will be free from defects in materials and workmanship for two years from the date of purchase.

This warranty does not apply to any products that have been repaired or altered by persons other than repair personnel authorized by Advantech, or products that have been subject to misuse, abuse, accident, or improper installation. Advantech assumes no liability under the terms of this warranty as a consequence of such events.

Because of Advantech's high quality-control standards and rigorous testing, most customers never need to use our repair service. If an Advantech product is defective, it will be repaired or replaced free of charge during the warranty period. For out-of-warranty repairs, customers will be billed according to the cost of replacement materials, service time, and freight. Please consult your dealer for more details.

If you believe your product is defective, follow the steps outlined below.

1. Collect all the information about the problem encountered (for example, CPU speed, Advantech products used, other hardware and software used, etc.). Note anything abnormal and list any onscreen messages displayed when the problem occurs.
2. Call your dealer and describe the problem. Please have your manual, product, and any helpful information readily available.
3. If your product is diagnosed as defective, obtain a return merchandise authorization (RMA) number from your dealer. This allows us to process your return more quickly.
4. Carefully pack the defective product, a completed Repair and Replacement Order Card, and a proof of purchase date (such as a photocopy of your sales receipt) into a shippable container. Products returned without a proof of purchase date are not eligible for warranty service.
5. Write the RMA number clearly on the outside of the package and ship the package prepaid to your dealer.

Declaration of Conformity

FCC

This device complies with the requirements in part 15 of the FCC rules:

Operation is subject to the following two conditions:

- This device may not cause harmful interference.
- This device must accept any interference received, including interference that may cause undesired operation.

This equipment has been tested and found to comply with the limits for a Class B digital device, pursuant to Part 15 of the FCC Rules. These limits are designed to provide reasonable protection against harmful interference when the equipment is operated in a commercial environment. This equipment generates, uses, and can radiate radio frequency energy and, if not installed and used in accordance with the instruction manual, may cause harmful interference to radio communications. Operation of this device in a residential area is likely to cause harmful interference in which case the user will be required to correct the interference at his/her own expense. The user is advised that any equipment changes or modifications not expressly approved by the party responsible for compliance would void the compliance to FCC regulations and therefore, the user's authority to operate the equipment.

Caution! *There is a danger of a new battery exploding if it is incorrectly installed. Do not attempt to recharge, force open, or heat the battery. Replace the battery only with the same or equivalent type recommended by the manufacturer. Discard used batteries according to the manufacturer's instructions.*



Technical Support and Assistance

1. Visit the Advantech website at <http://support.advantech.com> to obtain the latest product information.
2. Contact your distributor, sales representative, or Advantech's customer service center for technical support if you need additional assistance. Please have the following information ready before calling:
 - Product name and serial number
 - Description of your peripheral attachments
 - Description of your software (operating system, version, application software, etc.)
 - A complete description of the problem
 - The exact wording of any error messages

Warnings, Cautions, and Notes

Warning! Warnings indicate conditions that if not observed can cause personal injury!



Caution! Cautions are included to help prevent hardware damage and data losses. For example:



“Batteries are at risk of exploding if incorrectly installed. Do not attempt to recharge, force open, or heat the battery. Replace the battery only with the same or equivalent type as recommended by the manufacturer. Discard used batteries according to the manufacturer's instructions.”

Note! Notes provide additional information.



Safety Instructions

1. Read these safety instructions carefully.
2. Retain this user manual for future reference.
3. Disconnect the equipment from all power outlets before cleaning. Use only a damp cloth for cleaning. Do not use liquid or spray detergents.
4. For pluggable equipment, the power outlet socket must be located near the equipment and easily accessible.
5. Protect the equipment from humidity.
6. Place the equipment on a reliable surface during installation. Dropping or letting the equipment fall may cause damage.
7. The openings on the enclosure are for air convection. Protect the equipment from overheating. Do not cover the openings.
8. Ensure that the voltage of the power source is correct before connecting the equipment to a power outlet.
9. Position the power cord away from high-traffic areas. Do not place anything over the power cord.
10. All cautions and warnings on the equipment should be noted.
11. If the equipment is not used for a long time, disconnect it from the power source to avoid damage from transient overvoltage.
12. Never pour liquid into an opening. This may cause fire or electrical shock.
13. Never open the equipment. For safety reasons, the equipment should be opened only by qualified service personnel.
14. If any of the following occurs, have the equipment checked by service personnel:
 - The power cord or plug is damaged.
 - Liquid has penetrated the equipment.
 - The equipment has been exposed to moisture.
 - The equipment is malfunctioning, or does not operate according to the user manual.
 - The equipment has been dropped and damaged.
 - The equipment shows obvious signs of breakage.
15. Do not leave the equipment in an environment with a storage temperature of below $-40\text{ }^{\circ}\text{C}$ ($-40\text{ }^{\circ}\text{F}$) or above $85\text{ }^{\circ}\text{C}$ ($185\text{ }^{\circ}\text{F}$) as this may damage the components. The equipment should be kept in a controlled environment.
16. **CAUTION:** Batteries are at risk of exploding if incorrectly replaced. Replace only with the same or equivalent type as recommended by the manufacturer. Discard used batteries according to the manufacturer's instructions.
17. In accordance with the IEC 704-1:1982 specifications, the sound pressure level at the operator's position does not exceed 70 dB (A).
18. **RESTRICTED ACCESS AREA:** The equipment should only be installed in a Restricted Access Area.

DISCLAIMER: These instructions are provided according to IEC 704-1 standards. Advantech disclaims all responsibility for the accuracy of any statements contained herein.

Safety Precautions

Warning! Always completely disconnect the power cord from your chassis whenever you work with the hardware. Do not make connections while the power is on. Sensitive electronic components can be damaged by sudden power surges. Only experienced electronics personnel should open the PC chassis.



Caution! Always ground yourself to remove any static charge before touching the motherboard. Modern electronic devices are very sensitive to static electric discharges. As a safety precaution, use a grounding wrist strap at all times. Place all electronic components on a static-dissipative surface or in a static-shielded bag when they are not in the chassis.



Caution! The computer is provided with a battery-powered Real-time Clock circuit. There is a danger of explosion if the battery is incorrectly replaced. Replace only with same or equivalent type recommended by the manufacturer. Discard used batteries according to the manufacturer's instructions.



Caution! There is a danger of a new battery exploding if it is incorrectly installed. Do not attempt to recharge, force open, or heat the battery. Replace the battery only with the same or equivalent type recommended by the manufacturer. Discard used batteries according to the manufacturer's instructions.



Packing List

Before system installation, check that the items listed below are included and in good condition. If any item does not accord with the list, contact your dealer immediately.

- MIC-770 V3 bare-bone system x 1
- Startup Manual EN\CN\TC for MIC-770 V3 1st Ed. P/N: 2041077050
- 4-pin Phoenix connector P/N: 1652003234
- 2 x Mounting brackets P/N: 1960070543T00A
- 1 x SATA cable P/N: 1700013095-01
- 1 x SATA Power cable P/N: 1700024372-01
- 1 x CPU thermal grease P/N: 2170000093-01
- 2 x RAM thermal pads P/N: 1990019498N000

Ordering Information

Part Number	VGA	HDMI	2.5" HDD /SSD	mSATA	NVMe M.2	USB3.2 (Gen2)	USB 3.2 (Gen1)	USB 2.0	GbE	COM	PCIe/PCI Exp.	Power
MIC-770V3W-00A1	1	1	1	1	1	2	6	0	2	2, up to 6 (Optional)	i-module (Optional)	9~36 V _{DC}
MIC-770V3H-00A1	1	1	1	1	0	0	4	4	2	2, up to 6 (Optional)	i-module (Optional)	9~36 V _{DC}

Optional i-Module

Module Number	Description
4-slot expansion module	
MIC-75M13-00A2	1 x PCIe x16+3xPCI slot i-module
2-slot expansion module	
MIC-75M20-00C1	1 x PCIe x16+1xPCIe x4 slot i-module
MIC-75M20-01A2**	2 x PCIe x8 slot i-module
MIC-75M11-00A2	1 x PCIe x16+1xPCI slot i-module
1-slot expansion module	
MIC-75M10-00A2	1 x PCIe x16 slot
Featured expansion module	
MIC-75S00-00A1	2 x removable storage
MIC-75S20-00A2**	1 x PCIe x16+ 1 x PCIe x4 slot+ 2x2.5" swappable HDD/SSD
MIC-75G20-10B1	1 x PCIe x16 (Double Deck)+1xPCIe x4+2 x 2.5" hot-swap HDD/SSD GPU slot i-module
MIC-75G30-00B1**	2 x PCIe x8 + 1 x PCIe x4 slot + 2 x 2.5" swappable HDD/SSD
MIC-75GF10-00A1	MIC-75GF10 MXM i-module, 1 PCIe x16 + 1 x PCIe x4
98R17520301	2 x 3.5" HDD kit

* Please refer to the i-Module datasheet for more details.

** R680E SKU only.

Optional Accessories

Part Number	Description
96PSA-A230W24P4-3	ADP A/D 100-240V 230W 24V C14 TERMINAL BLOCK 4P
1702002600	Power cord (USA) UL/CSA, 3-pin, 10A, 125V, 1.83M, 180 D
1700008921	Power Cord PSE 3P 7A 125V 183cm
1702002605	Power Cord (EU), 3-pin, 10A, 250V 1.83M, 90D
96PSD-A240W24-MN*	A/D 100-240V 240W 24V NDR DIN-Rail
1700031170-01	DC-DC power cord, A cable TEM*4/TEM*4 UL2464 18AWG 150 cm
1700029720-01	AC-DC power cord (US), M cable AC CONN 3P 183 cm
1700030520-01	AC-DC power cord (CN), M cable conn 3P CCC 10A 250V 150 cm
1700031408-01	AC-DC power cord (EU), M cable conn 3P/G-TEM*3 80 cm
AIIS-DIO32-00A1E**	AIIS GPIO module (32-bit)
PCA-TPMSPI-00A1	TPM 2.0 module (SPI)
98R17500001	MIC DVI FIO
98R17500101	MIC HDMI/Remote power on/off FIO
98R17500301	MIC HDMI kit FIO
98R17500401	MIC Remote power on/off FIO
98R17500601	MIC COMport kit FIO
98R17500701	MIC Remote power on/off kit for SFIO
98R17500801	MIC Reset/Remote power on/off/5V _{DC} kit FIO
98R17500901	MIC GPIO kit
98R17501001	MIC Display Port kit
98R17501101	MIC COM and HDMI kit
98910770301***	MIC NVMe + 4 LAN Advanced FIO
98910770401***	MIC NVMe Advanced FIO
98910770501***	MIC 4 PoE Advanced FIO
98R1752010E	2nd 2.5" HDD/SSD kit (used in 2-slot i-Module)
98R1752020E	MIC Dual SSD kit
98R17500201	MIC DIN-Rail Mounting kit (90/180)
98R17500210	MIC DIN-Rail Mounting kit (180)
98R17500501	MIC Wall Mount kit
i-Door Module (MOS series module)	Supports i-Door module (MOS series), except PoE Please refer to the Advantech website below or search for "iDoor Module Mini PCIe Expansion Kit". http://www.advantech.com.tw/products/idoor-module-mini-pcie-expansion-kit/sub_bc858a7f-a52b-441b-a59c-f511289f98bc
i-Door Module (PCM series module)	Supports i-Door module (PCM series) except PoE Please refer to the Advantech website below: http://www.advantech.com/products/idoor-technology-mini-pcieexpansion-kit/sub_efdb96af-a8f7-4cde-9592-dbf5c9794d16 Note: A bracket is required to affix the PCM series i-door module. Please refer to P/N: 1960065854N001 i Door_bracket

* Please refer to the Flex I/O datasheet for more details.

** AIIS-DIO32 requires a DB37 bracket (P/N: 1960068787N002)

*** R680E SKU only.

i-module Optional Accessories

Part Number	Description
98R1751300E	1 x 8 cm FAN module (for MIC-75M13/75M40/75S20)
98R1752000E	2 x 4 cm FAN module (for MIC-75M20/MIC-75M11)

Contents

Chapter 1	General Introduction	1
1.1	Introduction	2
1.2	Product Features.....	2
1.2.1	General	2
1.2.2	Display	2
1.2.3	Ethernet	3
1.2.4	SUSI API.....	3
1.2.5	WISE-iBMC Out-of-Band Power Management	3
1.3	Chipset.....	4
1.3.1	Functional Specifications	4
1.4	Mechanical Specifications.....	6
1.4.1	Dimensions	6
	Figure 1.1 MIC-770 V3 Mechanical Dimensions	6
1.4.2	Weight.....	6
1.5	Power Requirements.....	6
1.5.1	System Power.....	6
1.5.2	RTC Battery	6
1.6	Environment Specification.....	7
1.6.1	Operating Temperature.....	7
1.6.2	System Safety Certification Test Temperature	7
1.6.3	Relative Humidity	7
1.6.4	Storage Temperature.....	7
1.6.5	Vibration During Operation	7
1.6.6	Shock During Operation.....	7
1.6.7	Safety.....	7
1.6.8	EMC.....	7
Chapter 2	H/W Installation.....	9
2.1	Introduction	10
2.2	Jumpers & Slide Switches.....	10
2.2.1	Jumper Description	10
2.2.2	Jumper List	11
	Table 2.1: Jumper List.....	11
2.3	Connectors.....	12
2.3.1	MIC-770 V3 External I/O Connectors	12
	Figure 2.1 MIC-770 V3 Front View	12
	Table 2.2: COM Connector Pin Assignments	13
	Figure 2.2 Ethernet Connector	14
	Table 2.3: Ethernet Connector Pin Assignments.....	14
	Figure 2.3 Audio Connector.....	14
	Table 2.4: Audio Connector Pin Assignments	14
	Figure 2.4 USB 3.2/3.1 Connector.....	15
	Table 2.5: USB 3.0 Connector Pin Assignments.....	15
	Figure 2.5 VGA Connector	15
	Table 2.6: VGA Connector Pin Assignments.....	15
	Figure 2.6 HDMI Receptacle Connector.....	16
	Table 2.7: HDMI Connector Pin Assignments	16
	Figure 2.7 4-Pin Header	16
	Table 2.8: Pin Assignments for Power Connector Pin Header ..	16
	Figure 2.8 Power Button	17
	Figure 2.9 LED Indicators	17
2.4	Installation	18
2.4.1	HDD Installation.....	18

2.4.2	Memory Installation.....	20
2.4.3	m-SATA/Mini-PCIe Installation	21
2.4.4	Internal USB 2.0 Installation (R SKU only)	22
2.4.5	COM 3/4/5/6 Port Installation.....	22
2.4.6	Expansion Module Installation (Optional)	22
2.4.7	MIC-770 V3 MB I/O Connectors	23

Chapter 3 BIOS Operation 25

3.1	Introduction	26
	Figure 3.1 Main Setup Screen	26
3.2	Entering BIOS Setup.....	27
3.2.1	Main Menu	27
	Figure 3.2 Main Setup Screen	27
3.2.2	Advanced BIOS Features Setup.....	28
	Figure 3.3 Advanced BIOS Features Setup Screen.....	28
	Figure 3.4 iBMC Configuration	29
	Figure 3.5 Platform Misc Configuration	30
	Figure 3.6 CPU Configuration	31
	Figure 3.7 Power & Performance	33
	Figure 3.8 CPU - Power Management Control.....	33
	Figure 3.9 PCH-FW Configuration.....	34
	Figure 3.10AMT Configuration	35
	Figure 3.11CIRA Configuration	35
	Figure 3.12ASF Configuration	36
	Figure 3.13Secure Erase Configuration	37
	Figure 3.14OEM Flag Settings	38
	Figure 3.15MEBx Resolution Settings.....	39
	Figure 3.16Firmware Update Configuration	40
	Figure 3.17TPM Settings.....	41
	Figure 3.18 ACPI Settings.....	42
	Figure 3.19SMART Settings.....	43
	Figure 3.20Super IO Configuration.....	44
	Figure 3.21Serial Port 1 Configuration	44
	Figure 3.22Serial Port 2 Configuration	45
	Figure 3.23Serial Port 3 Configuration	45
	Figure 3.24Serial Port 4 Configuration	46
	Figure 3.25Serial Port 5 Configuration	46
	Figure 3.26Serial Port 6 Configuration	47
	Figure 3.27PC Health Status.....	48
	Figure 3.28S5 RTC Wake Settings	51
	Figure 3.29Serial Port Console Redirection	52
	Figure 3.30Legacy Console Redirection Settings	52
	Figure 3.31 Intel® TXT Information	53
	Figure 3.32USB Configuration.....	54
	Figure 3.33Network Stack Configuration.....	55
	Figure 3.34CSM Configuration	56
	Figure 3.35NVMe Configuration	57
3.2.3	Chipset.....	58
	Figure 3.36Chipset	58
	Figure 3.37System Agent (SA) Configuration	59
	Figure 3.38Memory Configuration	60
	Figure 3.39Graphics Configuration.....	61
	Figure 3.40PEG Port Configuration.....	62
	Figure 3.41PEG Port Feature Configuration	62
	Figure 3.42PCH-IO Configuration	63
	Figure 3.43PCI Express Configuration	64
	Figure 3.44PCI Express Root Port	65
	Figure 3.45SATA and RST Configuration	66

	Figure 3.46USB Configuration	67
	Figure 3.47Security Configuration	68
	Figure 3.48HD Audio Configuration	69
3.2.4	Security	70
	Figure 3.49Security	70
3.2.5	Boot	71
	Figure 3.50Boot	71
3.2.6	Save & Exit	72
	Figure 3.51Save & Exit	72
Chapter 4	Software Installation	73
4.1	Before you begin	74
4.2	Introduction	74
4.3	Windows Driver Setup.....	74
Chapter 5	Integrated Graphics Device Setup ...	75
5.1	Introduction	76
5.2	Windows Driver Setup.....	76
Chapter 6	Intel® ME	77
6.1	Introduction	78
6.2	Installation	78
Chapter 7	LAN Configuration.....	79
7.1	Introduction	80
7.2	Features	80
7.3	Installation	80
7.4	Windows Driver Setup.....	80
Chapter 8	SATA RAID Setup	81
8.1	Introduction	82
8.2	SATA RAID Driver and Utility Setup	82
Chapter 9	HD Audio	83
9.1	Introduction	84
9.2	Installation	84
Appendix A	Programming the Watchdog Timer..	85
A.1	Programming the Watchdog Timer	86
A.1.1	Watchdog Timer Overview.....	86
A.1.2	Programming the Watchdog Timer.....	86
	Table A.1: Watchdog Timer Registers	88
A.1.3	Example Program	89
Appendix B	Programming the GPIO	93

B.1	Supported GPIO Register	94
	B.1.1 GPIO Registers.....	94
	B.1.2 GPIO Example Program.....	95

Chapter 1

General Introduction

This chapter details background information on the MIC-770 V3.

1.1 Introduction

The Advantech MIC-770 V3 is a compact, fanless system that utilizes the latest generation Intel® 14nm platform with the new PCH R680E/H610E on a proprietary form factor motherboard. The design concept of the Advantech MIC-770 V3 system focuses on an "expansion slot module", allowing for different applications to integrate the MIC-770 V3 system when developing a complete industrial computer. Additionally, the MIC-770 V3 can function as an independent, fanless, compact embedded box computer and accepts a wide range of DC power input.

The rugged aluminum case provides an excellent thermal solution and resists high EMI as well as shock and vibration. The MIC-770 V3 is equipped with a 12th Gen Core™ i desktop CPU featuring up to 16 cores, making it highly suitable for embedded and industrial PC applications that require high processor performance within limited spaces. The system also features powerful I/O interfaces — including Ethernet, USB 3.2, serial port, and 2 x Mini PCIe.

Furthermore, the MIC-770 V3 (W SKU) adopts the Advantech WISE-iBMC out-of-band management solution, enabling remote power control via and NIC port & LAN2 should an abnormal OS operation occur.

1.2 Product Features

1.2.1 General

- **CPU:** 12th Gen Intel® Core™ i CPU socket (LGA1700)
- **PCH:** Intel® R680E/H610E
- **System Memory:** Dual-channel DDR5 4800 MHz, up to 32GB per socket (R680E SKU supports ECC)
- **Storage Devices:** Supports 1 x drive bay space for SATA 2.5" HDD/SSD (Up to 2 x with the optional kit)
- **NVMe M.2:** Supports 1 x M-Key 2280 with PCIe Gen 4 x 4 (R680E SKU, operating temp. of -20 ~ 50 °C)
- **mSATA:** Supports 1 x mSATA by Mini PCIe slot
- **Graphics:** VGA + HDMI
- **Ethernet Port:** 2 x RJ-45
- **Watchdog Timer:** Single-chip watchdog 255-level interval timer, set up by software
- **I/O Interface:** 2 x RS-232/422/485 supports auto flow control; 4 x RS-232 via optional cable
- **USB:**
 - R680E: 2 x USB 3.2 (Gen.2), 6 x USB 3.2 (Gen.1) and 1 x USB 2.0 (internal)
 - H610E: 4 x USB 3.2 (Gen.2), 4 x USB 2.0
- **Audio:** High Definition Audio (HD), Line-out, Mic-in
- **Expansion interface:**
 - R680E: 1 x Mini PCIe, 1 x Mini PCIe / mSATA
 - H610E: 1 x Mini PCIe, 1 x mSATA

1.2.2 Display

- **Chipset: R680E:** Intel® UHD Graphics 770
- **Resolution:**
 - VGA: Supports up to 1920x1200 @60 Hz

- HDMI: Supports up to 4096x2160 @30Hz

1.2.3 Ethernet

- **Controller:**
 - R680E LAN1: Intel® I219LM, LAN2: Intel® i210IT (supports iBMC)
 - H610E LAN1: Intel® I219V, LAN2: Intel® i210IT
- **Speed:** 10/100/1000 Mbps
- **Interface:** 2 x RJ-45
- **Standard:** Compliant with IEEE 802.3, IEEE802.3u, IEEE 802.ab.

1.2.4 SUSI API

MIC-770 V3 supports SUSI API which helps customers to develop their own remote management programs under Windows 10.

1.2.5 WISE-iBMC Out-of-Band Power Management

- MIC-770 V3 R680E SKU is equipped with the WISE-iBMC solution which provides out-of-band management for remote power-on/power-off/reset/force-shut-down via LAN2 if abnormal conditions are selected.

Note! The WISE-iBMC power control function is operated on Advantech WISE-DeviceOn software. Before installation and setup of the WISE-Agent program, changing the device IP address to the same as your network IP via a utility tool is necessary. Please refer to the product support website to download the iBMC utility, DeviceOn software, and SOP/ user manual.



1.3 Chipset

1.3.1 Functional Specifications

1.3.1.1 Processor

Processor	Intel® 12th Gen Core i CPU socket (LGA1700)
------------------	---

1.3.1.2 Chipset

PCH	<ul style="list-style-type: none">■ Intel® R680E/H610E chipset
Memory	<ul style="list-style-type: none">■ Supports DDR5 4800MHz MHz ECC RAM (R680E SKU only) (without ECC)■ SODIMM Socket:<ul style="list-style-type: none">– 260-pin SODIMM socket*2 (up to 32GB per socket)
Chipset integrated Intel HD Graphic	<ul style="list-style-type: none">■ Intel® UHD Graphics 770■ Supports DirectX 12■ Supports OpenGL 4.5■ Supports Intel® Quick Sync Video■ I/O interface<ul style="list-style-type: none">– VGA: Supports resolutions up to 1920 x 1200 @60 Hz (VGA connector: On-board D-SUB 15P)– HDMI: Supports resolution up to 4096 x 2160 @30Hz (HDMI Connector: On-board HDMI)
SATA Interface	<ul style="list-style-type: none">■ 3 x SATA 3.0 (W SKU), 2 x SATA 3.0 (H SKU)■ Legacy IED (Including IRQ)/Native AHCI appearance to OS■ Partial/slumber power management modes with wake■ Capable of 6Gbit/s transfer rate
USB Interface	<ul style="list-style-type: none">■ R680E: 2 x USB 3.2 (Gen 2) and 6 x USB 3.2 (Gen 1)■ H610E: 4 x USB 3.2 (Gen 2) and 4 x USB 2.0■ Supports high-speed, full-speed, and low-speed capable■ Supports legacy keyboard/mouse software
Power Management	<ul style="list-style-type: none">■ Supports ACPI 5.0■ ACPI Power Management Logic supported■ Power Connector: plug-in block 4Px1
BIOS	<ul style="list-style-type: none">■ AMI 256Mb (R SKU)/256Mb (H SKU) Flash BIOS via SPI

Note! Legacy platform is not supported.



1.3.1.3 Others

Serial ports	<p>Nuvoton NCT 6126D supported</p> <ul style="list-style-type: none"> ■ Up to 6 serial ports by Nuvoton NCT6126D supported. ■ High-speed NS16C550A compatible UARTs with data rates up to 1.5 Mbps. ■ Supports IRQ sharing among serial port . ■ COM1/2: Supports RS-232/422/485 and setting mode by BIOS and supports auto flow control. ■ COM 3~6: Support for RS-232, via optional cable. <p>Serial port connector: D-SUB CON.9P</p>
LAN	<p>R680E LAN1: Intel® I219LM (PHY), LAN2: Intel® i210IT I210IT (NIC) (Support iBMC)</p> <p>H610E LAN1: Intel® I219V (PHY), LAN2: Intel® i210IT I210IT (NIC)</p> <ul style="list-style-type: none"> ■ Compliant with IEEE 802.3, IEEE 802.3u, IEEE 802.ab. ■ Supports 10/100/1000 Mbps. ■ Supports Wake on LAN.
Audio	<p>Audio Codec: Realtek ALC888S:</p> <ul style="list-style-type: none"> ■ Compliant with HD Audio specifications. ■ Supports to 16/20/24-bit DAC and 16/20/24-bit ADC resolution. ■ Supports: Line-out, Mic-in. ■ DAC supports 16/20/24-bit PCM format, multiple stereo recording.
Industrial Features	<p>Watchdog Timer:</p> <ul style="list-style-type: none"> ■ Can generate system reset or NC. The watchdog timer is programmable, with each unit equal to one second (255 levels).
Battery Backup	<ul style="list-style-type: none"> ■ BR2032 3 V/190mAh

1.4 Mechanical Specifications

1.4.1 Dimensions

UNIT : mm

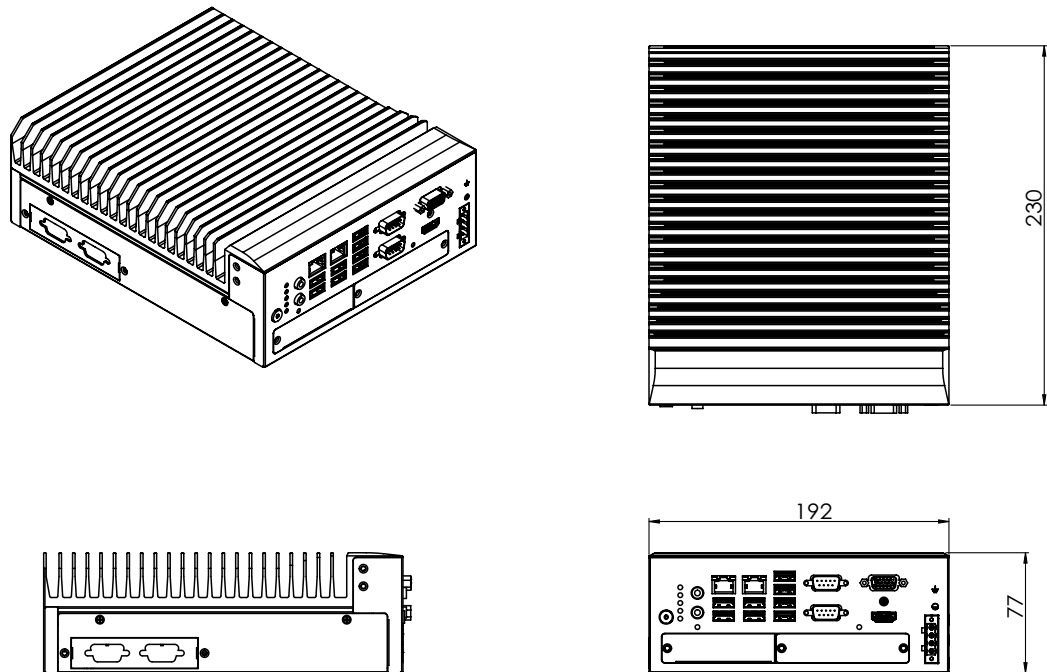

Figure 1.1 MIC-770 V3 Mechanical Dimensions

1.4.2 Weight

2.8 kg (6.17 lb)

1.5 Power Requirements

1.5.1 System Power

- Minimum power input: DC12V (-25%) -30V (+20%), Absolute Maximum Ratings Voltage is 9V - 36V.

1.5.2 RTC Battery

- BR2032 3 V/190 mAh

1.6 Environment Specification

1.6.1 Operating Temperature

- -20 ~ 50 °C (4 ~ 122 °F) (65W CPU) & -20 ~ 60 °C (4 ~ 140 °F) (35W CPU) with 0.7m/sec airflow; with 1 x Industrial wide-temp SSD

1.6.2 System Safety Certification Test Temperature

- 0 ~ 40 °C with (32 ~ 104 °F) 2.5" SSD

1.6.3 Relative Humidity

- 95% @40 °C (non-condensing)

1.6.4 Storage Temperature

- -40 ~ 85 °C (-40 ~ 185 °F)

1.6.5 Vibration During Operation

- When the system is equipped with SSD only: 3 Grms, IEC 60068-2-64, random, 5 ~ 500 Hz, 1 hr/axis, x,y,z 3 axes.
- When the system is equipped with 2.5-inch HDD: 1 Grms, IEC 60068-2-64, random, 5 ~ 500 Hz, 1 hr/axis, x,y,z 3 axes.

1.6.6 Shock During Operation

- When the system is equipped with SSD only: 20 G, IEC 60068-2-27, half sine, 11 ms duration.

1.6.7 Safety

- UL/CB, CCC, BSMI

1.6.8 EMC

- CE, FCC, CCC, BSMI

Chapter 2

H/W Installation

This chapter introduces external I/O and the installation of MIC-770 V3 hardware.

2.1 Introduction

The following sections show the internal jumper settings and the external connectors and pin assignments.

2.2 Jumpers & Slide Switches

2.2.1 Jumper Description

You may configure the MIC-770 V3 to match the needs of your application by setting jumpers. A jumper is a metal bridge used to close an electric circuit. It consists of two metal pins and a small metal clip (often protected by a plastic cover) that slides over the pins to connect them. To close a jumper, you connect the pins with the clip. To open a jumper, you remove the clip. Sometimes a jumper will have three pins, labeled 1, 2, and 3. In this case you would connect either pins 1 and 2, or 2 and 3.

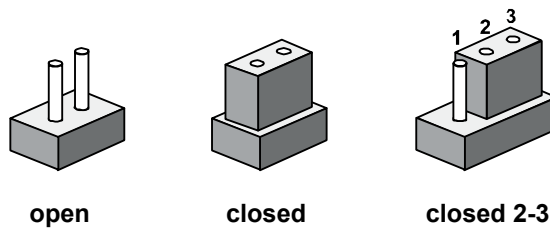

The jumper settings are schematically depicted in this manual as follows.

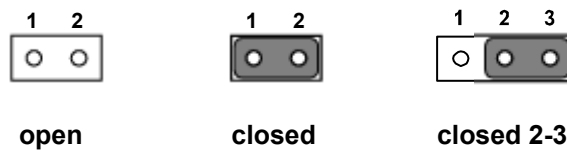

A pair of needle-nose pliers may be helpful when working with jumpers. If you have any doubts about the best hardware configuration for your application, contact your local distributor or sales representative before you make any changes. Generally, you simply need a standard cable to make most connections.

2.2.2 Jumper List

Table 2.1: Jumper List

Label	Function
JCMOS1	Clear CMOS
PSON1	System AT/ATX mode option
JME1	ME jumper mode option
JWDT1_JOBS1	Watchdog mode option

2.2.2.1 Clear CMOS

The MIC-770 V3 single-board computer contains a jumper that can erase CMOS data and reset the system BIOS information. Normally, this jumper should be set with pins 1-2 closed. If you want to reset the CMOS data, set CMOS1 to 2-3 closed for just a few seconds, and then move the jumper back to 1-2 closed. This procedure will reset the CMOS to its default setting.

CMOS1	Clear CMOS
Footprint	3x1 Pin
Setting	Function
(1-2)	Normal (default)
(2-3)	Clear CMOS

2.2.2.2 System AT/ATX Mode Function Option

MIC-770 V3 supports AT or ATX mode and the default is the ATX module. If you want to change to AT mode you can find the AT/ATX mode jumper on the motherboard.

PSON1	System AT/ATX mode option
Footprint	3x1 Pin
Setting	Function
(1-2)	AT module
(2-3)	ATX module

2.2.2.3 System ME Mode Function Option

MIC-770 V3 supports ME Enable & Disable and the default is "Disable". If you want to change the ME mode, you can set the ME mode jumper on the motherboard.

JME1	System ME mode option
Footprint	3x1 Pin
Setting	Function
(1-2)	ME Enable
(2-3)	ME Disable (Default)

2.2.2.4 System Watchdog Mode Function Option

The MIC-770 V3 single-board computer contains a jumper that can set the watchdog mode.

JWDT1_JOBS1	Watchdog mode function option
Footprint	5x1 pin
Setting	Function
(2-3)	Watchdog

2.2.2.5 USB Standby Power & VGA Always-On Setting (DIP Switch)

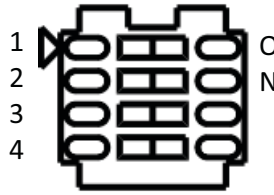

DIP Switch (SW1)

Switch	State	Setting
SW1-1	1 (default)	USB3C1 does not provide standby charging
	On	USB3C1 provides standby charging
SW1-2	2 (default)	USB3C2 does not provide standby charging
	On	USB3C2 provides standby charging
SW1-3	3 (default)	USB3C3 does not provide standby charging
	On	USB3C3 provides standby charging
SW1-4	4 (default)	VGA is always on
	On	VGA will be ON if cable is detected

2.3 Connectors

2.3.1 MIC-770 V3 External I/O Connectors

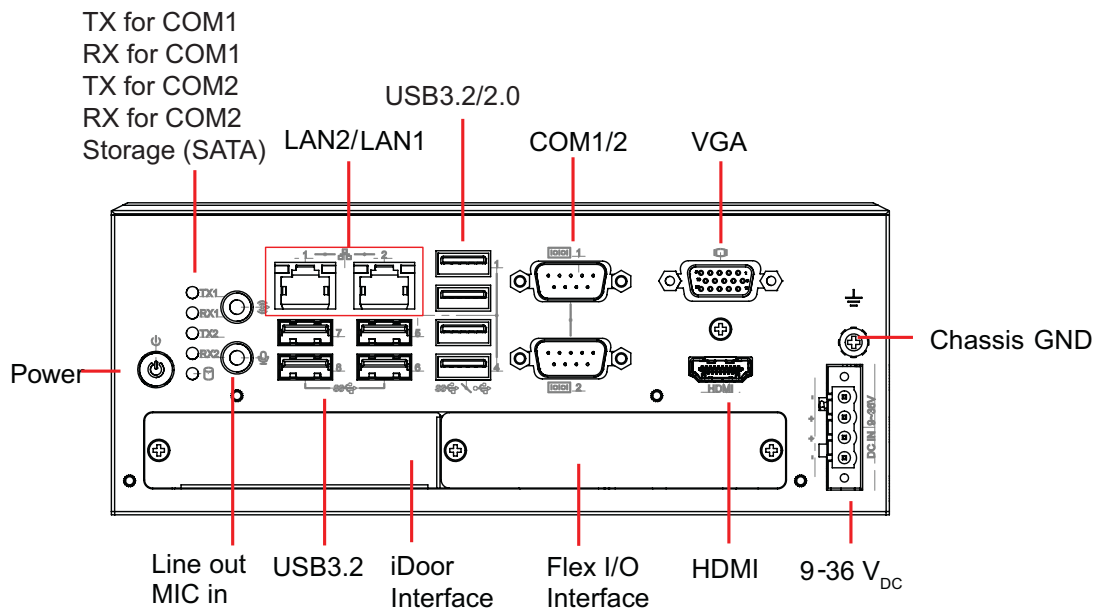

Figure 2.1 MIC-770 V3 Front View

2.3.1.1 COM Connector

MIC-770 V3 provides two 9-pin D-sub connectors and offers RS-232/422/485 serial communication interface ports. The default setting is ES-232, but this can be modified in the BIOS settings. You can find detailed instructions in Chapter 3.

Note! *Expandable for four more optional RS-232 cables.*



Table 2.2: COM Connector Pin Assignments

	RS-232	RS-422	RS-485
Pin	Signal Name	Signal Name	Signal Name
1	DCD	Tx-	DATA-
2	RxD	Tx+	DATA+
3	TxD	Rx+	NC
4	DTR	Rx-	NC
5	GND	GND	GND
6	DSR	NC	NC
7	RTS	NC	NC
8	CTS	NC	NC
9	RI	NC	NC

Note! *NC represents “No Connection”.*



2.3.1.2 Ethernet Connector (LAN)

MIC-770 V3 is equipped with two Ethernet controllers that are fully compliant with IEEE 802.3u 10/100/1000 Mbps CSMA/CD standards. LAN1 is equipped with Intel i219 and LAN2 is equipped with Intel i210. The Ethernet port provides a standard RJ-45 jack connector with LED indicators on the front side to show its Active/Link status and Speed status.

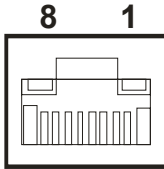

Figure 2.2 Ethernet Connector

Table 2.3: Ethernet Connector Pin Assignments

Pin	10/100/1000BaseT Signal Name
1	TX+
2	TX-
3	RX+
4	MDI2+
5	MDI2-
6	RX-
7	MDI3+
8	MDI3-

2.3.1.3 Audio Connectors

MIC-770 V3 has two stereo audio ports with phone jack connectors, one Line-Out, and one Mic-In. The audio chip is controlled by ALC888S, and is compliant with AZALIA standards.



Figure 2.3 Audio Connector

Table 2.4: Audio Connector Pin Assignments

Pin	Audio Signal Name
1	Line_Out
2	Mic_In

2.3.1.4 USB 3.0 Connector

MIC-770 V3 provides USB 3.2/3.1 interface connectors, which provide complete Plug & Play and hot swapping capabilities for up to 127 external devices. The USB interface complies with USB XHCI, Rev. 3.0. Please refer to the table below for pin assignments.

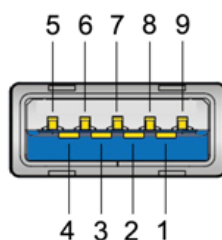

Figure 2.4 USB 3.2/3.1 Connector

Table 2.5: USB 3.0 Connector Pin Assignments

Pin 1	+5V
Pin 2	USB Data -
Pin 3	USB Data +
Pin 4	GND
Pin 5	SSRX-
Pin 6	SSRX+
Pin 7	GND
Pin 8	SSTX-
Pin 9	SSTX+

2.3.1.5 VGA Connector

The MIC-770 V3 provides a high-resolution VGA interface with a 15-pin D-sub connector to support a VGA CRT monitor. It supports a display resolution of up to 2048 x 1152 @ 60 Hz.

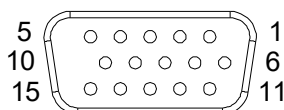

Figure 2.5 VGA Connector

Table 2.6: VGA Connector Pin Assignments

Pin	Signal Name	Pin	Signal Name
1	Red	2	Green
3	Blue	4	NC
5	GND	6	GND
7	GND	8	GND
9	+5V	10	GND
11	NC	12	DDC_DAT
13	H-SYNC	14	V-SYNC
15	DDC_CLK		

2.3.1.6 HDMI Connector

An integrated 19-pin receptacle connector HDMI Type-A Interface is provided. The HDMI link supports resolutions of up to 4096 x 2160 @ 30Hz.

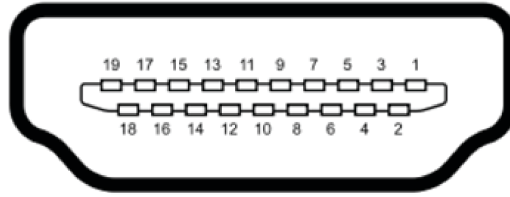

Figure 2.6 HDMI Receptacle Connector

Table 2.7: HDMI Connector Pin Assignments

Pin	Signal Name	Pin	Signal Name
1	TMDS Data 2+	2	TMDS Data 2 shield
3	TMDS Data 2-	4	TMDS Data 1+
5	TMDS Data 1 shield	6	TMDS Data 1-
7	TMDS Data 0+	8	TMDS Data 0 shield
9	TMDS Data 0-	10	TMDS clock+
11	TMDS clock shield	12	TMDS clock-
13	CEC	14	Reserved
15	SCL	16	SDA
17	DDC/CEC Ground	18	+5V
19	Hot Plug Detect		

2.3.1.7 Power Input Connector

MIC-770 V3 comes with a four-pin header as default that carries 9V_{DC} - 36V_{DC} external power input.

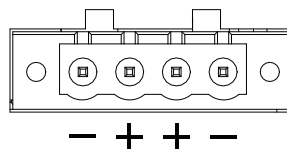

Figure 2.7 4-Pin Header

Table 2.8: Pin Assignments for Power Connector Pin Header

Pin	Signal Name
1	GND
2	+9 V _{DC} ~ 36 V _{DC}
3	+9 V _{DC} ~ 36 V _{DC}
4	GND

2.3.1.8 Power ON/OFF Button

MIC-770 V3 comes with a Power On/Off button with LED indicators on the front side to show its On status (Green LED) and Off/Suspend status (RED LED). It supports dual functions of Soft Power-On/Off (instant off or delay 4 seconds), and suspend.

Power button LED status:

System On: LED On

System Suspend: Fast flashes

System Off: Off

System Off in deep sleep: Off

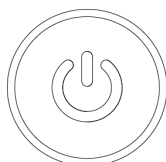

Figure 2.8 Power Button

2.3.1.9 LED Indicators

MIC-770 V3 provides COM1 & COM2 TX/RX LED for data transmission status monitoring.

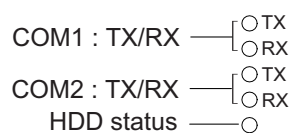
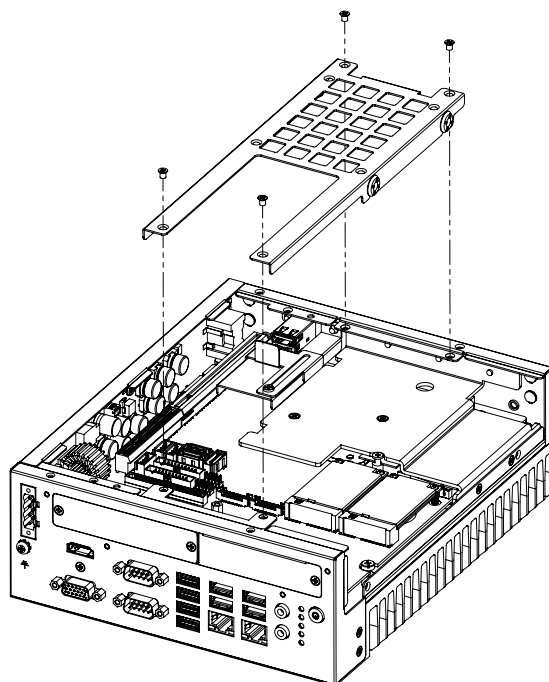
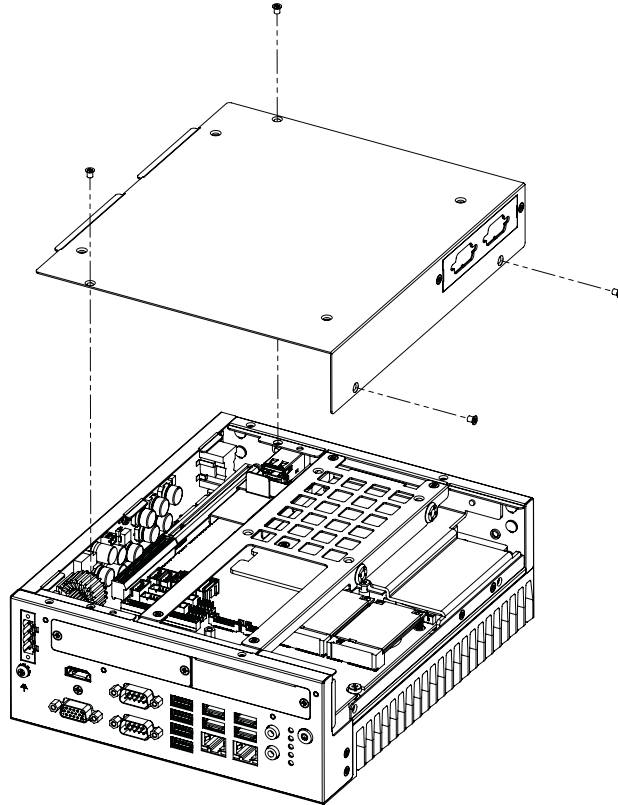

Figure 2.9 LED Indicators

2.4 Installation

2.4.1 HDD Installation

1. Undo the 4 screws and remove the bottom cover.
2. Undo the 4 screws to remove the HDD tray.



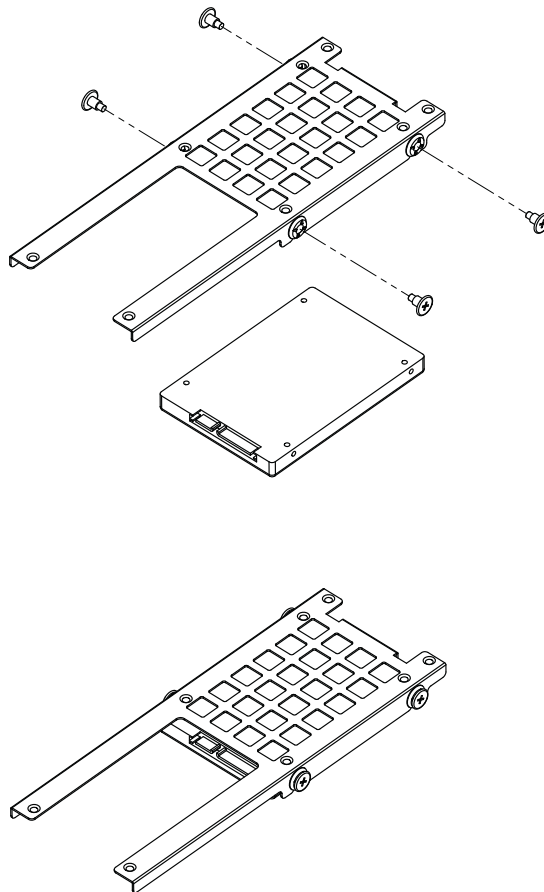

3. Secure the HDD with 4 x HDD screws (P/N:1930002235).
4. Assemble the SATA cable/power cable and replace the HDD tray; secure with 4 screws.
5. Replace the bottom cover.

Note! Please refer to the *i-Module Manual* for *i-module* assembly.



2.4.2 Memory Installation

1. Undo the 4 screws to remove the bottom cover.
2. Undo the 7 screws to remove the memory thermal cover and install the memory and affix the thermal pad (P/N: 1990019498N000).

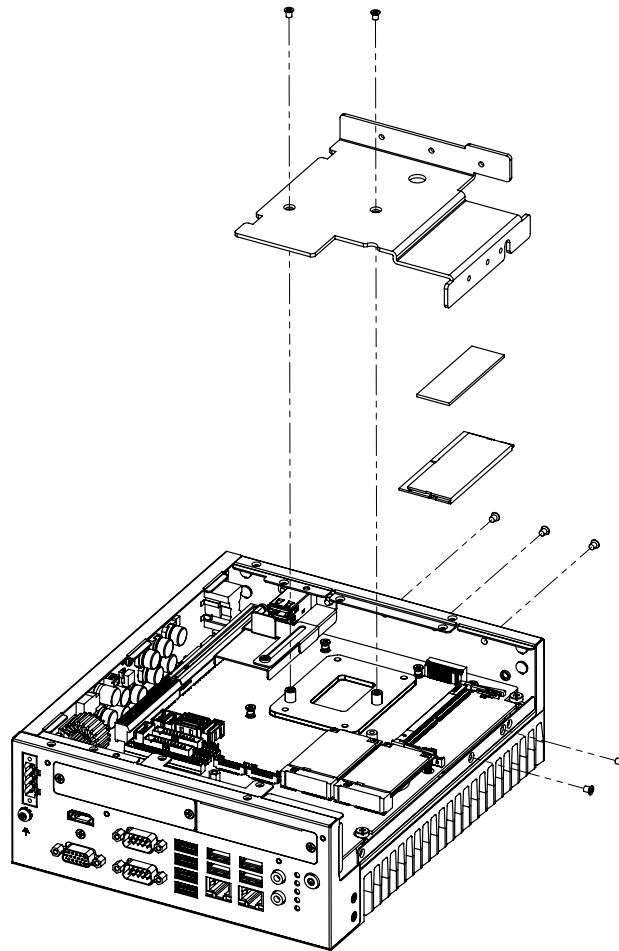

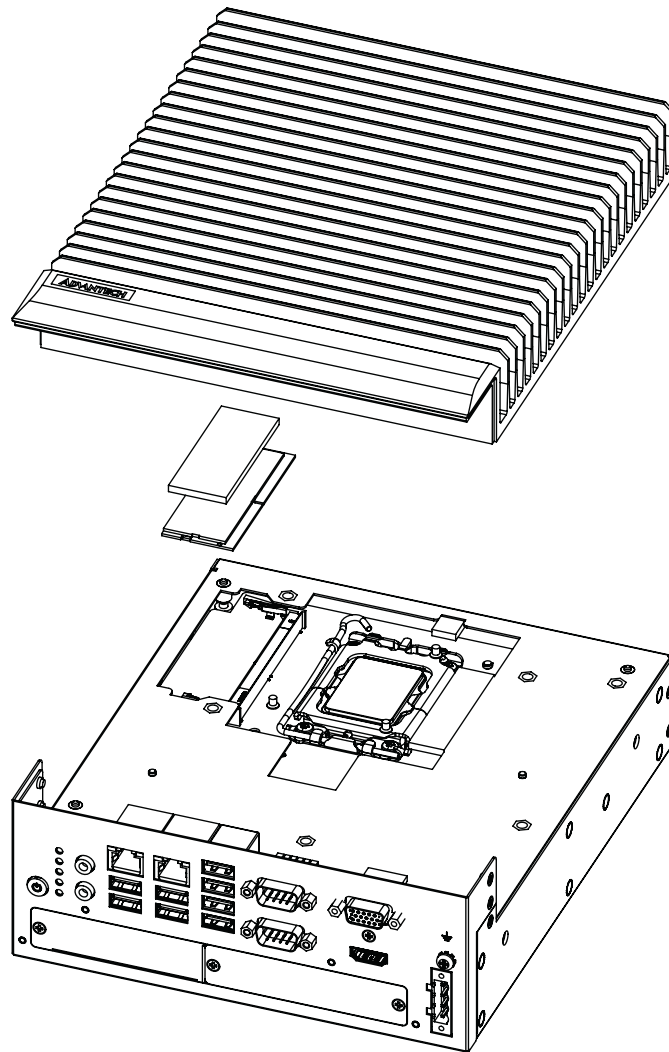

3. Undo the 3 screws to remove the memory thermal cover.
4. Affix the thermal pad (P/N: 1990019498N000) to the memory and reassemble the memory.

Note! *The thermal pad and memory thermal cover must be completely covered and secured.*



2.4.3 m-SATA/Mini-PCIe Installation

- R680E: 1 x Mini PCIe (via Nano-SIM), 1 x Mini PCIe / mSATA
 - H610E: 1 x Mini PCIe (via Nano-SIM), 1 x mSATA
1. Undo the 4 x screws and remove the bottom cover.
 2. Install the module in Mini PCIe socket 1, or m-SATA in Mini PCIe socket 2 and secure with screws.
 3. Replace the bottom cover and secure with screws.

2.4.4 Internal USB 2.0 Installation (R SKU only)

1. Undo the 4 x screws and remove the bottom cover.
2. Loosen the screws and adjust the bracket size in accordance with the USB dongle size.
3. Replace the bottom cover and secure with screws.

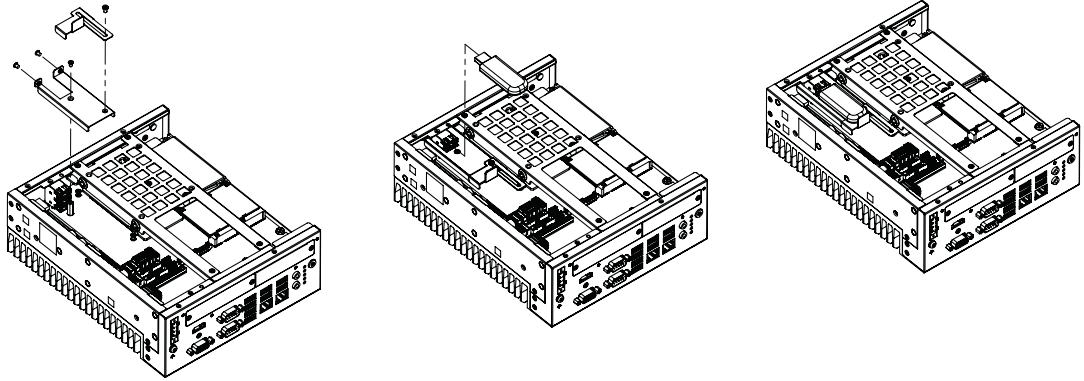

2.4.5 COM 3/4/5/6 Port Installation

MIC-770 V3 supports 2 x standard RS-232/422/485 serial ports. If more serial ports are needed, MIC-770 V3 can be expanded for up to 4 x serial ports by Flex I/O 98R17500601 (RS-232 only).

1. Replace the baffle plate for COM 3/4 and COM5/6.
2. Remove the HDD tray.
3. Assemble the DB9 connector and baffle, and install the cable at the COM3/4 and COM5/6 connectors.
4. Secure the COM module in the system and replace the HDD tray/bottom cover.

2.4.6 Expansion Module Installation (Optional)

MIC-770 V3 supports the following optional modules for different applications.

A: Expansion modules:

1. 98R17500001 MIC DVI FIO
2. 98R17500101 MIC HDMI/Remote power on/off FIO
3. 98R17500301 MIC HDMI kit FIO
4. 98R17500401 MIC Remote power on/off FIO
5. 98R17500601 MIC COM port kit FIO
6. 98R17500701 MIC Remote power on/off kit for SFIO
7. 98R17500801 MIC Reset/Remote power on/off/5V_{DC} kit FIO
8. 98R17500901 MIC GPIO kit FIO
9. 98R17501001 MIC DP kit FIO
10. AIIS-DIO32-00A1E** AIIS GPIO module (32-bit)
11. PCA-TPMSPI-00A1 TPM 2.0 module (SPI)

** AIIS-DIO32 requires a DB37 bracket (P/N: 1960068787N002)

B: Bracket for expansion modules

1. Undo the 4 x screws and remove the bottom cover.
2. Undo the HDD tray & expansion module baffle.

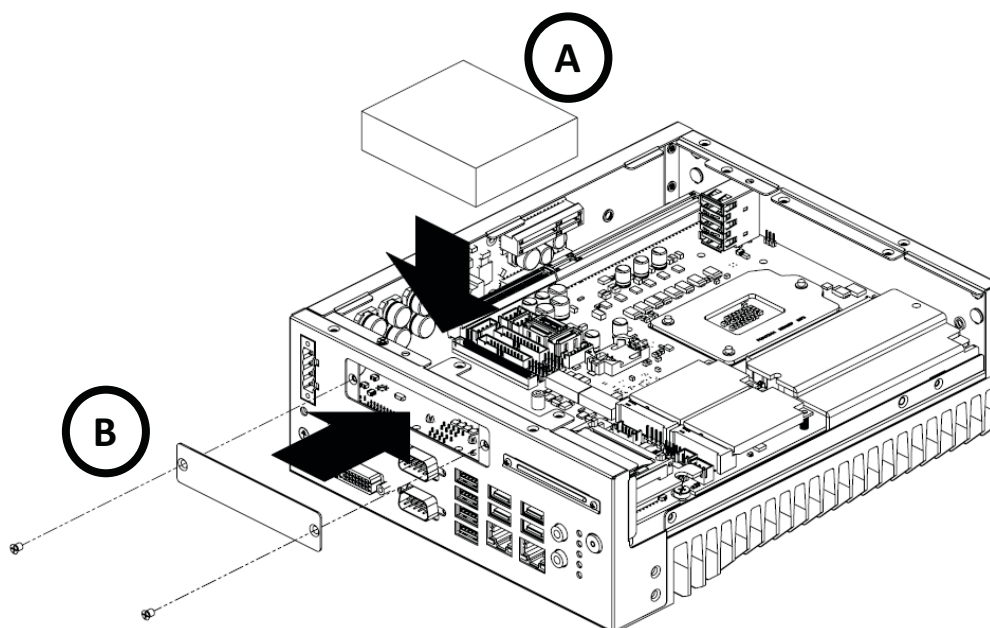

3. Remove the baffle cover.
4. Assemble the module on the motherboard (Note: Optional expansion modules need to be connected with a cable. (Please refer to MB internal I/O connector specifications on the I/O connector page for GPIO connectors.)
5. Assemble the module baffle with screws.
6. Replace the bottom cover and secure with screws.

2.4.7 MIC-770 V3 MB I/O Connectors

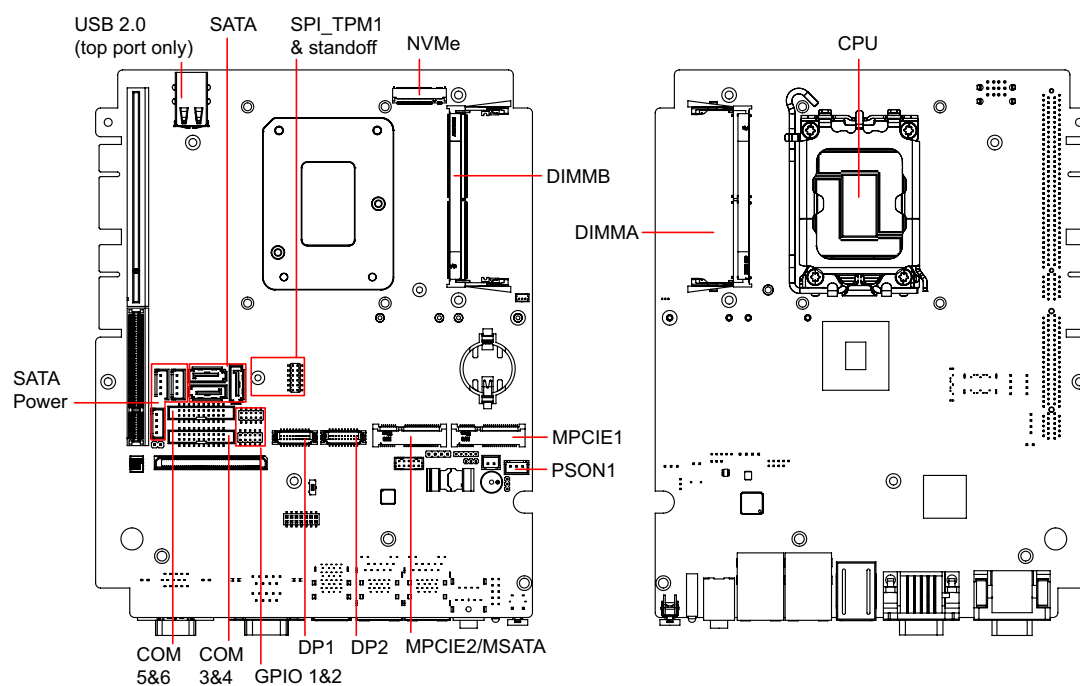

Chapter 3

BIOS Operation

3.1 Introduction

With the AMI BIOS Setup Utility, you can modify BIOS settings and control the specific features of your computer. The Setup Utility uses a number of menus for making changes and turning the specific features on or off. This chapter describes the basic navigation of the MIC-770 V3 setup screens.

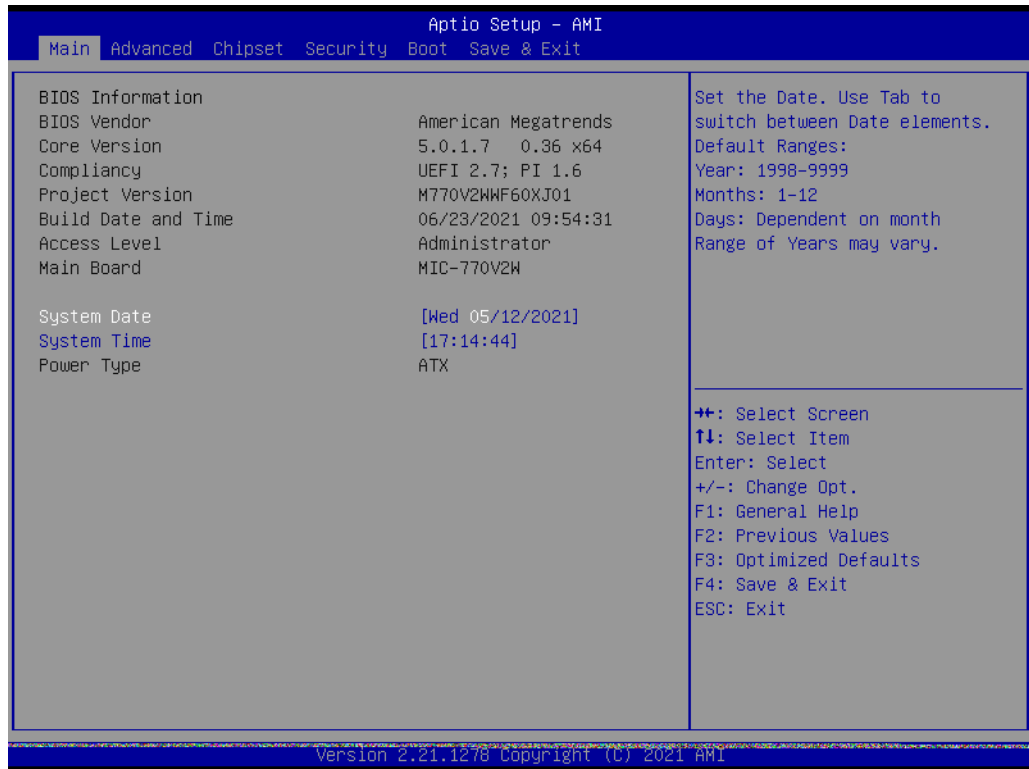

Figure 3.1 Main Setup Screen

AMI's BIOS ROM has a built-in Setup program that allows users to modify the basic system configuration. This information is stored in the NVRAM area, so it retains the setup information when the power is turned off.

3.2 Entering BIOS Setup

Press at bootup to enter the AMI BIOS Setup Utility. The Main Menu will appear on the screen. Use the arrow keys to select among the items and press <Enter> to accept or enter the sub-menu.

The Main BIOS setup screen has two main frames. The left frame displays all the options that can be configured. Grayed-out options cannot be configured; options in blue can be. The right frame displays the key legend.

The key legend above is an area reserved for a text message. When an option is selected in the left frame, it is highlighted in white. Often a text message will accompany it.

3.2.1 Main Menu

When users first enter the BIOS Setup Utility, they enter the Main setup screen. Users can always return to the Main setup screen by selecting the Main tab. There are two Main setup options described in this section. The Main BIOS setup screen is shown below.

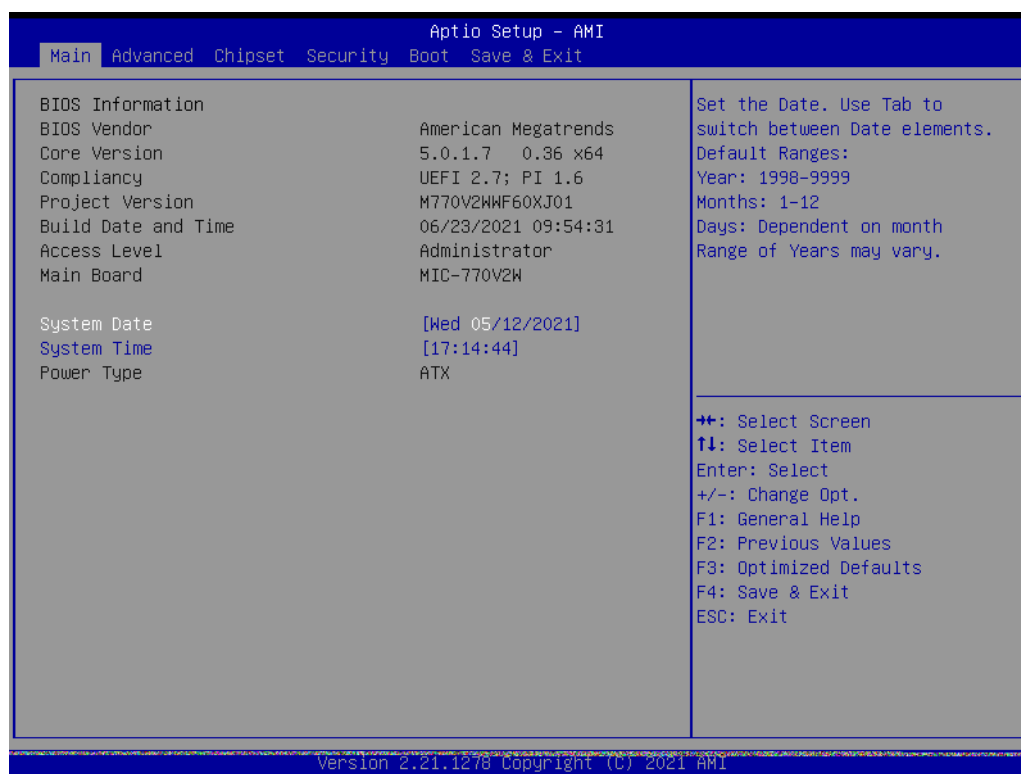

Figure 3.2 Main Setup Screen

The Main BIOS setup screen has two main frames. The left frame displays all the options that can be configured. Grayed-out options cannot be configured; options in blue can be. The right frame displays the key legend.

The key legend above is an area reserved for a text message. When an option is selected in the left frame, it is highlighted in white. Often a text message will accompany it.

■ System Date / System Time

Use this option to change the system time and date. Highlight System Date or System Time using the <Arrow> keys. Enter new values through the keyboard. Press the <Tab> key or the <Arrow> keys to move between fields. The date must be entered in MM/DD/YY format. The time must be entered in HH:MM:SS format.

3.2.2 Advanced BIOS Features Setup

Select the Advanced tab from the MIC-770 V3 setup screen to enter the Advanced BIOS setup screen. You can select any of the items in the left frame of the screen, such as CPU configuration, to go to the sub-menu for that item. You can display an Advanced BIOS setup option by highlighting it using the <Arrow> keys. All Advanced BIOS setup options are described in this section. The Advanced BIOS setup screens are shown below. The sub-menus are described on the following pages.

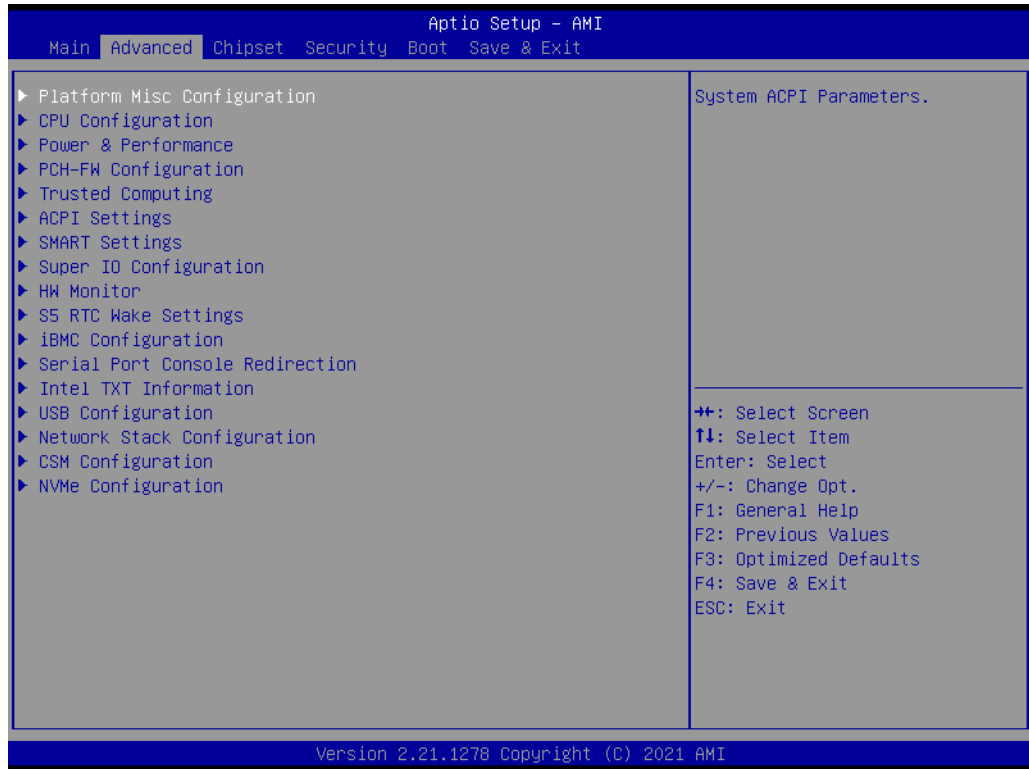

Figure 3.3 Advanced BIOS Features Setup Screen

3.2.2.1 iBMC Configuration



Figure 3.4 iBMC Configuration

- **iBMC**

"Enable" or "Disable" the iBMC controller's hardware communication. The default setting is "Enabled". The iBMC controller/function can be disabled if the item is selected as "Disabled".

3.2.2.2 Platform Misc Configuration



Figure 3.5 Platform Misc Configuration

- **Native PCIE Enable**
"Enable" or "Disable" PCI Express native support.

3.2.2.3 CPU Configuration

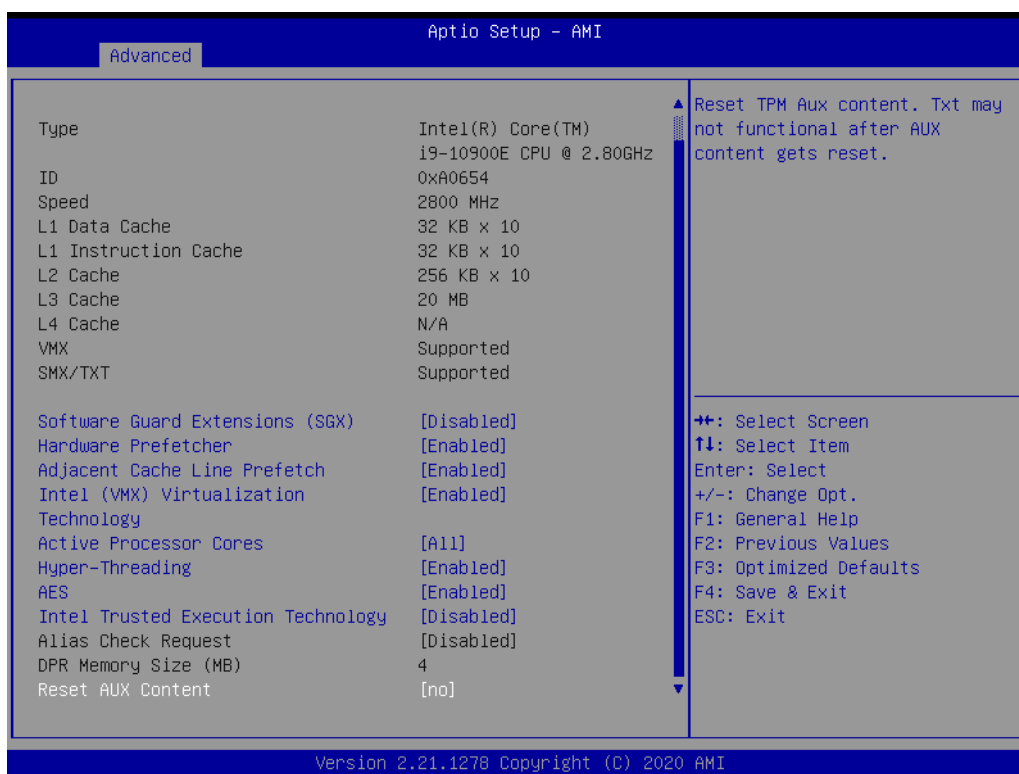
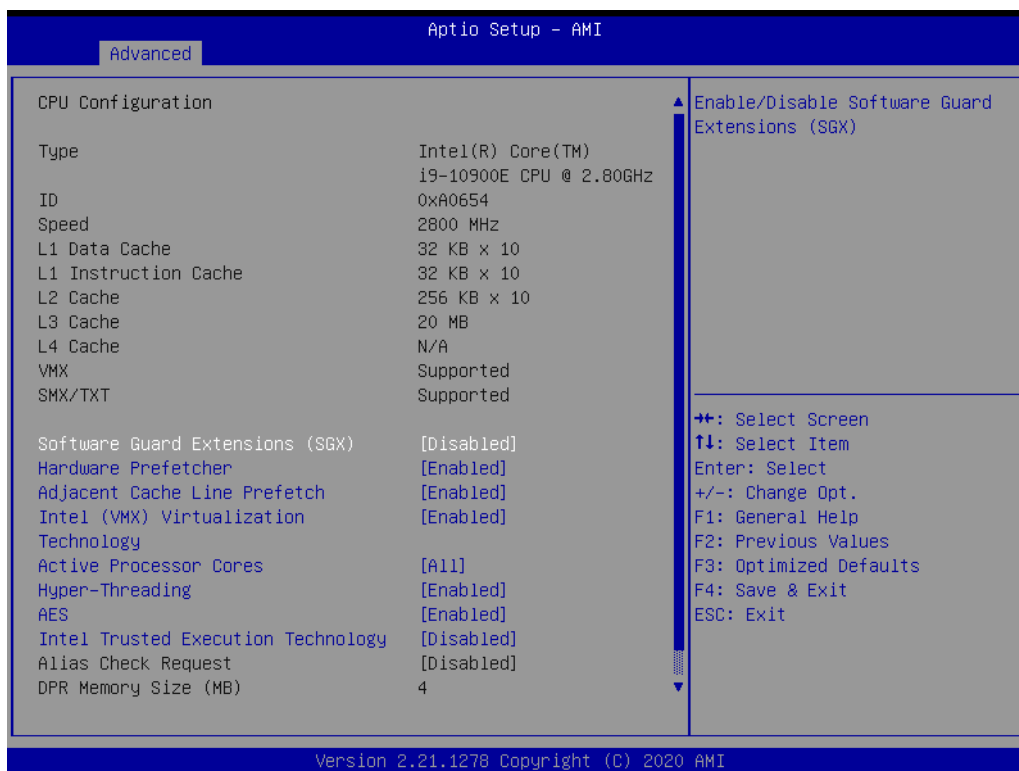

Figure 3.6 CPU Configuration

- **Software Guard Extensions (SGX)**
"Enable" or "Disable" software control of Intel® Software Guard Extensions.

-
- **Hardware Prefetcher**

Hardware Prefetcher is a technique that fetches instructions and/or data from memory into the CPU cache memory well before the CPU needs it to improve the load-to-use latency. You may choose to "Enable" or "Disable" it.
 - **Adjacent Cache Line Prefetch**

The Adjacent Cache-Line Prefetch mechanism, like automatic hardware prefetch, operates without programmer intervention. When it is enabled through the BIOS, two 64-byte cache lines are fetched into a 128-byte sector, regardless of whether the additional cache line has been requested or not. You may choose to "Enable" or "Disable" it.
 - **Intel® Virtualization Technology**

This feature is used to "Enable" or "Disable" the Intel® Virtualization Technology (IVT) extension. It allows multiple operating systems to run simultaneously on the same system by creating virtual machines, each running its own x86 operating system.
 - **Active Processor Core**

Use this item to select the number of processor cores you want to activate when you are using a multi-core processor.
 - **Hyper-Threading**

"Enable" or "Disable" Intel® Hyper-Threading technology.
 - **AES**

"Enable" or "Disable" CPA advanced encryption standard instruction.
 - **Intel® Trusted Execution Technology**

"Enable" or "Disable" utilization of additional hardware capabilities provided by Intel Trusted Execution Technology. Changes require a full power cycle to take effect.
 - **Rest AUX Content**

Reset TPM AUX content. TXT may not be functional after AUX content gets reset.

3.2.2.4 Power & Performance



Figure 3.7 Power & Performance

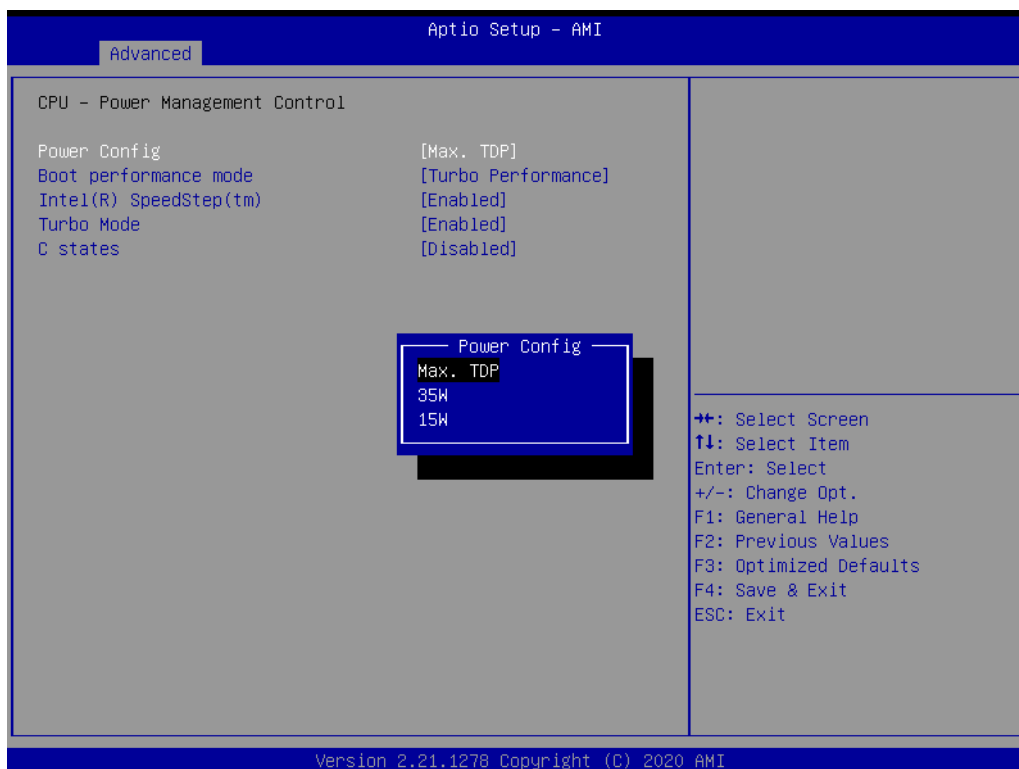

Figure 3.8 CPU - Power Management Control

- Power Config**
 Default is Max. TDP which enables the user to adjust CPU TDP to 35W or 15W according to the user's requirements.

- **Boot Performance**
Select the performance state that the BIOS will set before OS handoff.
- **Intel® Speedstep™**
Allows more than two frequency ranges to be supported.
- **Turbo Mode**
"Enable" or "Disable" processor turbo mode.
- **C states**
Intel® C states setting for power saving.

3.2.2.5 PCH-FW Configuration

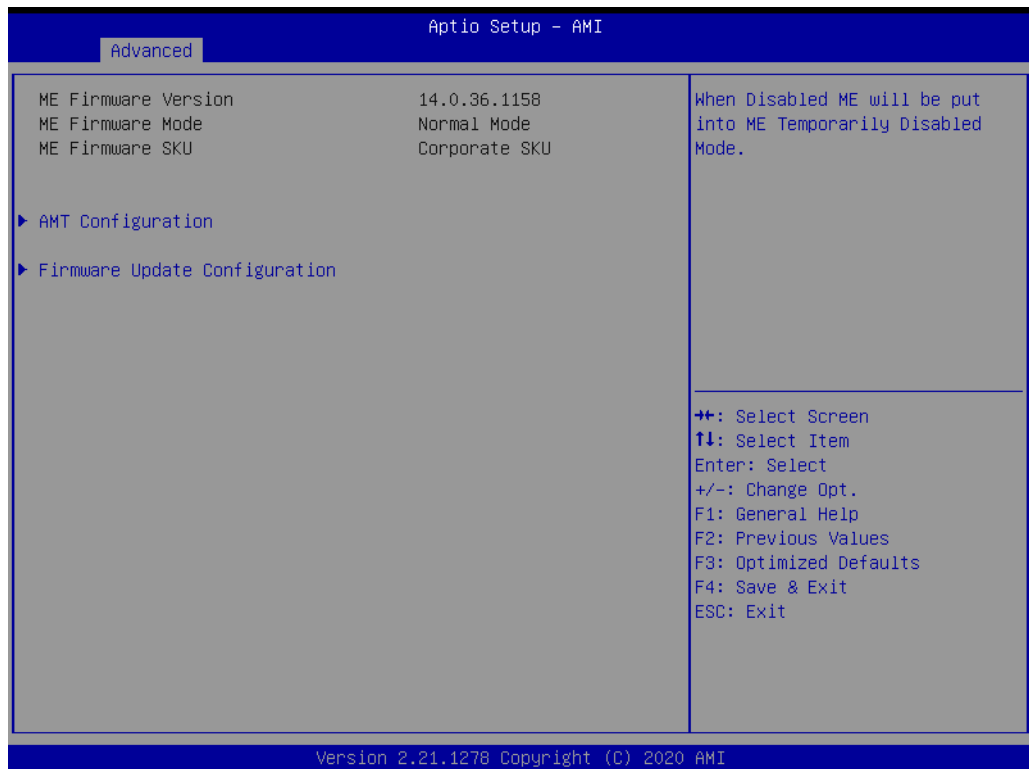

Figure 3.9 PCH-FW Configuration

- **PCH-FW Version**
PCH-FW page shows Intel® ME FW information.

■ AMT Configuration

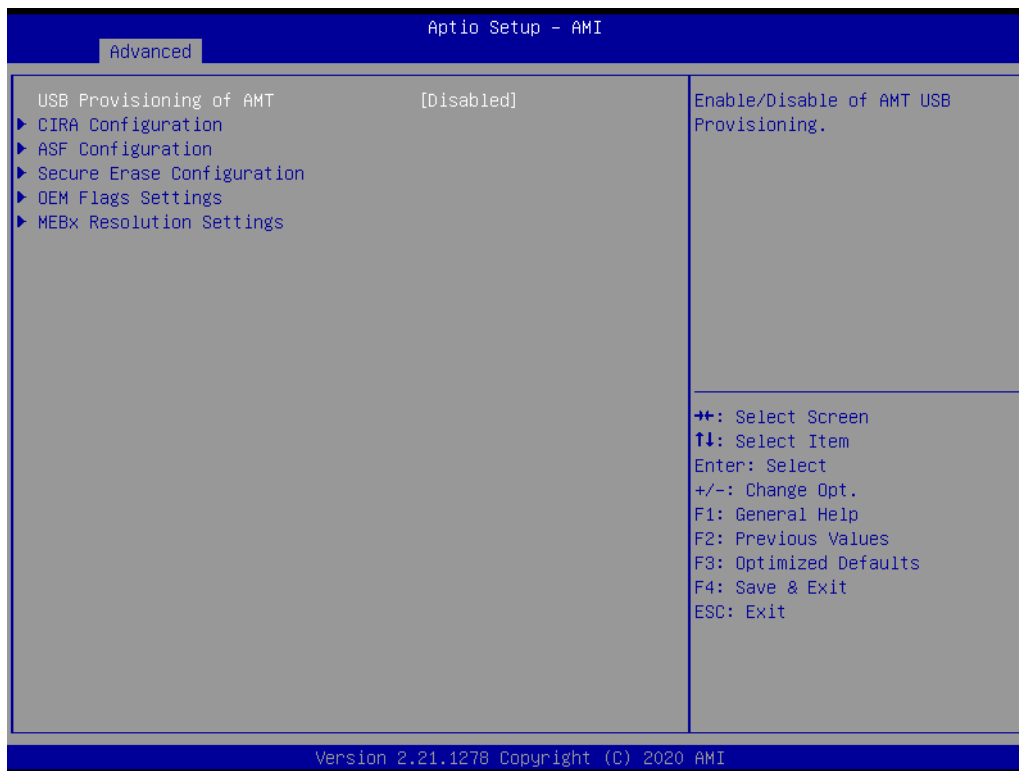

Figure 3.10 AMT Configuration

■ CIRA Configuration

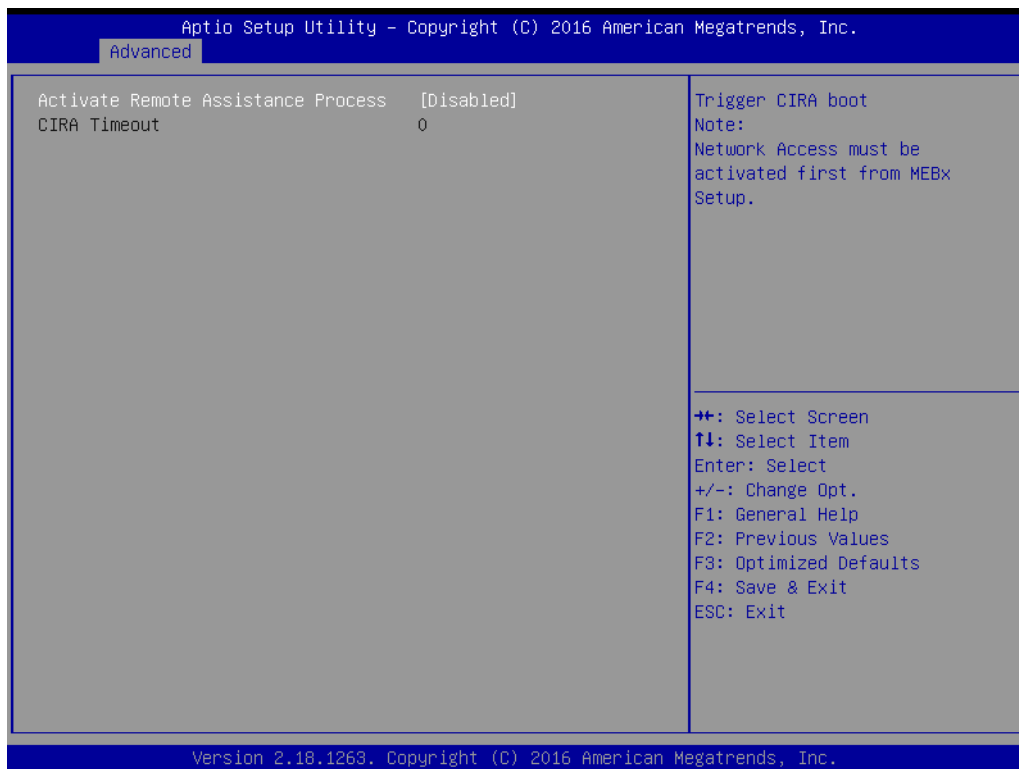

Figure 3.11 CIRA Configuration

- **Activate Remote Assistance Process**
Trigger CIRA boot.

■ ASF Configuration

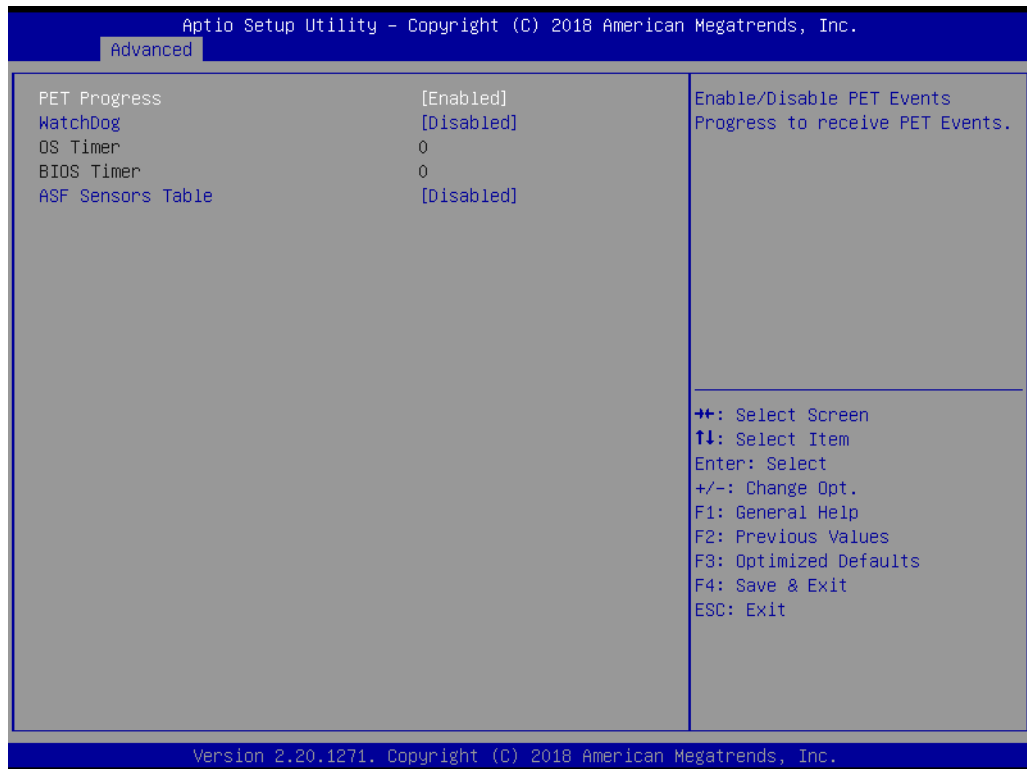

Figure 3.12 ASF Configuration

- **PET Progress**
"Enable" or "Disable" PET events Progress to receive PET events.
- **WatchDog**
"Enable" or "Disable" Watchdog Timer.
- **ASF Sensors Table**
"Enable" or "Disable" to add ASF Sensor Table into the ASF ACPI Table.

■ Secure Erase Configuration

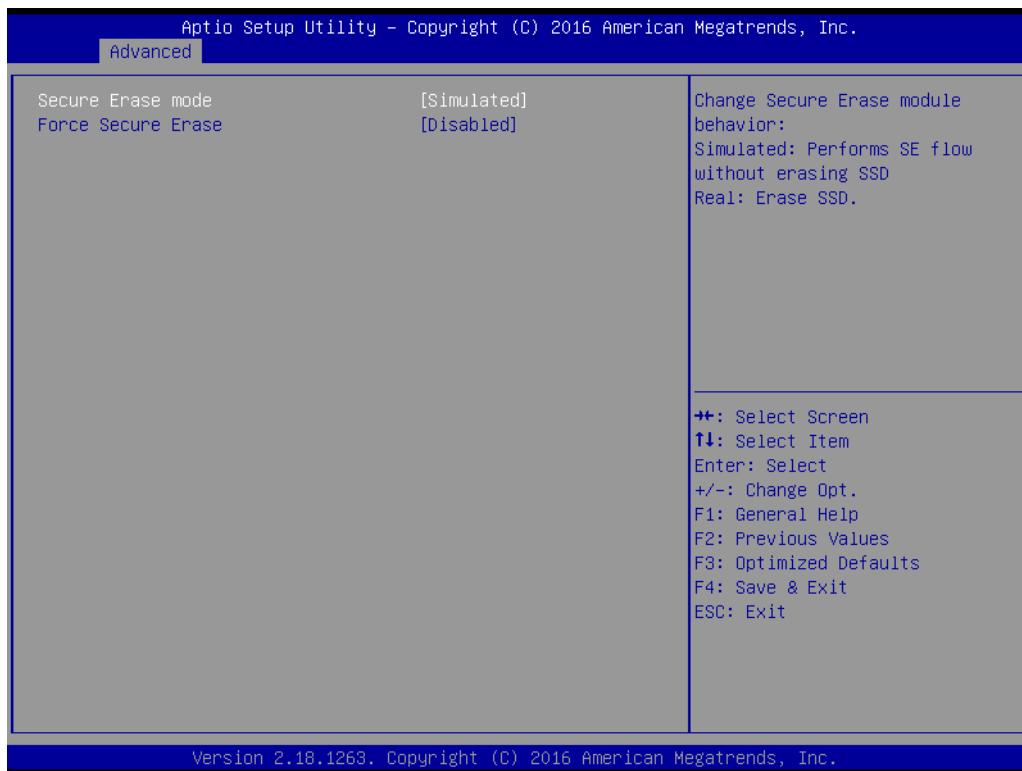

Figure 3.13 Secure Erase Configuration

- **Secure Erase mode**

Change Secure Erase module behavior as "Simulated" or "Real".

- **Force Secure Erase**

"Enable" or "Disable" force Secure Erase on next boot.

■ OEM Flag Settings

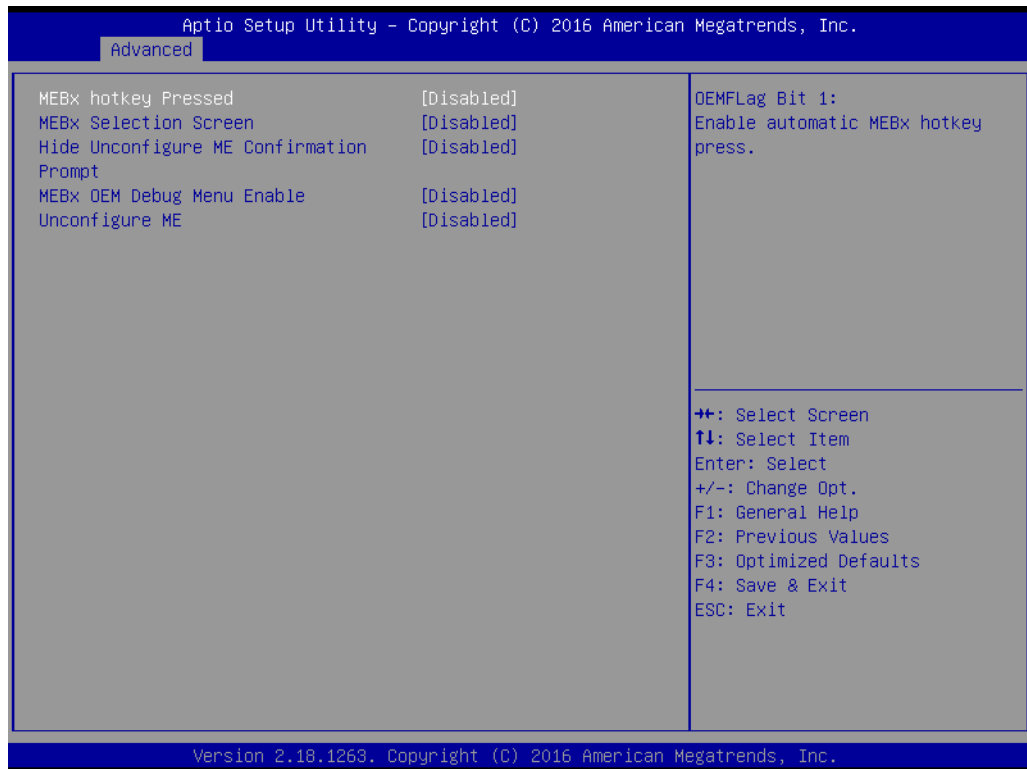

Figure 3.14 OEM Flag Settings

- **MEBx hotkey Pressed**
"Enable" or "Disable" automatic MEBx hotkey press.
- **MEBx Selection Screen**
"Enable" or "Disable" MEBx Selection Screen.
- **Hide Un-Configure ME Confirmation Prompt**
Hide Un-Configure ME without password confirmation prompt.
- **MEBx OEM Debug Menu Enable**
"Enable" or "Disable" OEM debug menu in MEBx.
- **Unconfigure ME**
Unconfigure ME without password.

■ MEBx Resolution Settings

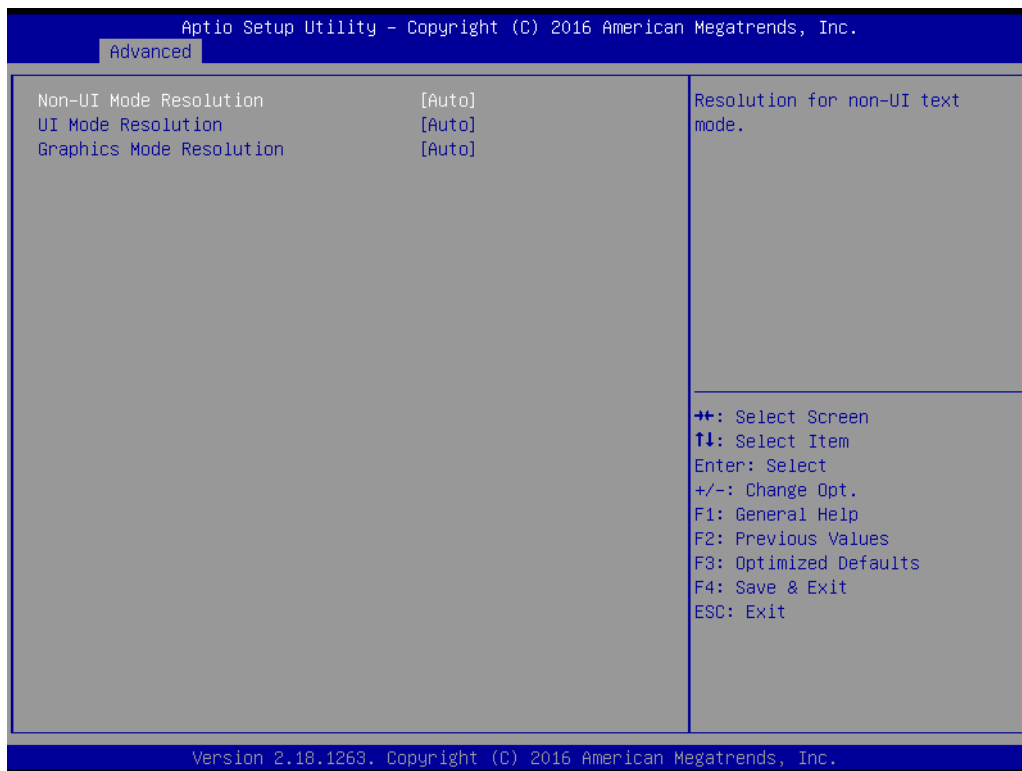

Figure 3.15 MEBx Resolution Settings

- **Non-UI Mode Resolution**
Set resolution for non-UI text mode.
- **UI Mode Resolution**
Set resolution for UI text mode.
- **Graphics Mode Resolution**
Set resolution for graphics mode.

■ Firmware Update Configuration

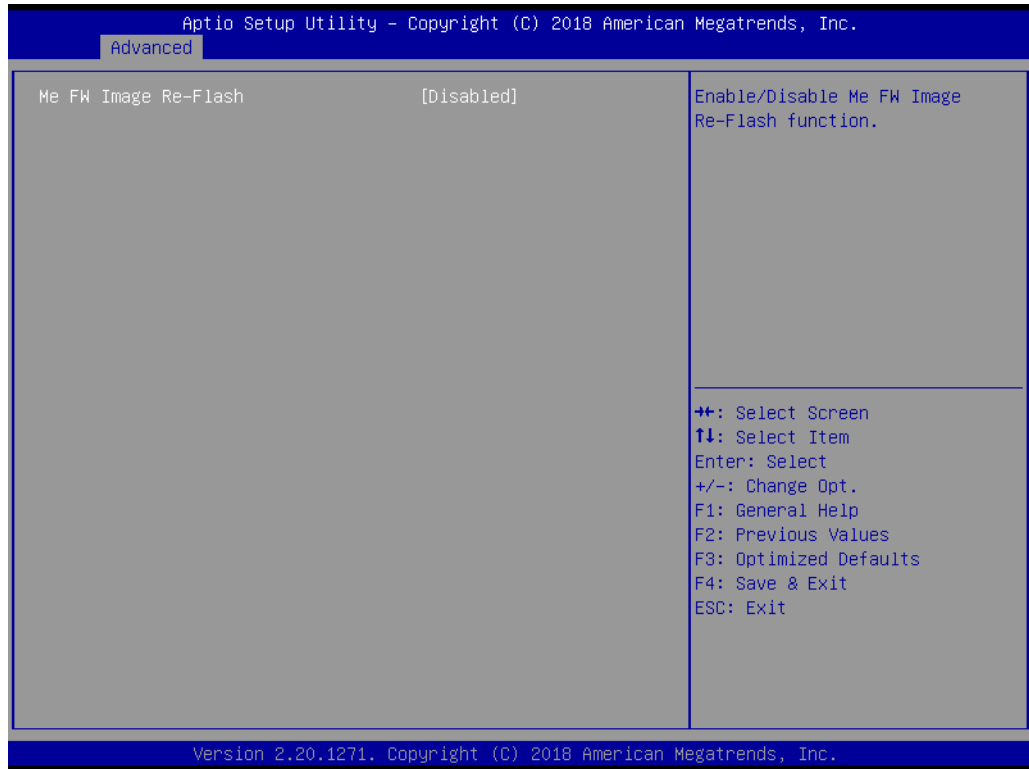

Figure 3.16 Firmware Update Configuration

– ME FW Image Re-flash

"Enable" or "Disable" ME firmware image re-flash function.

3.2.2.6 Trusted Computing

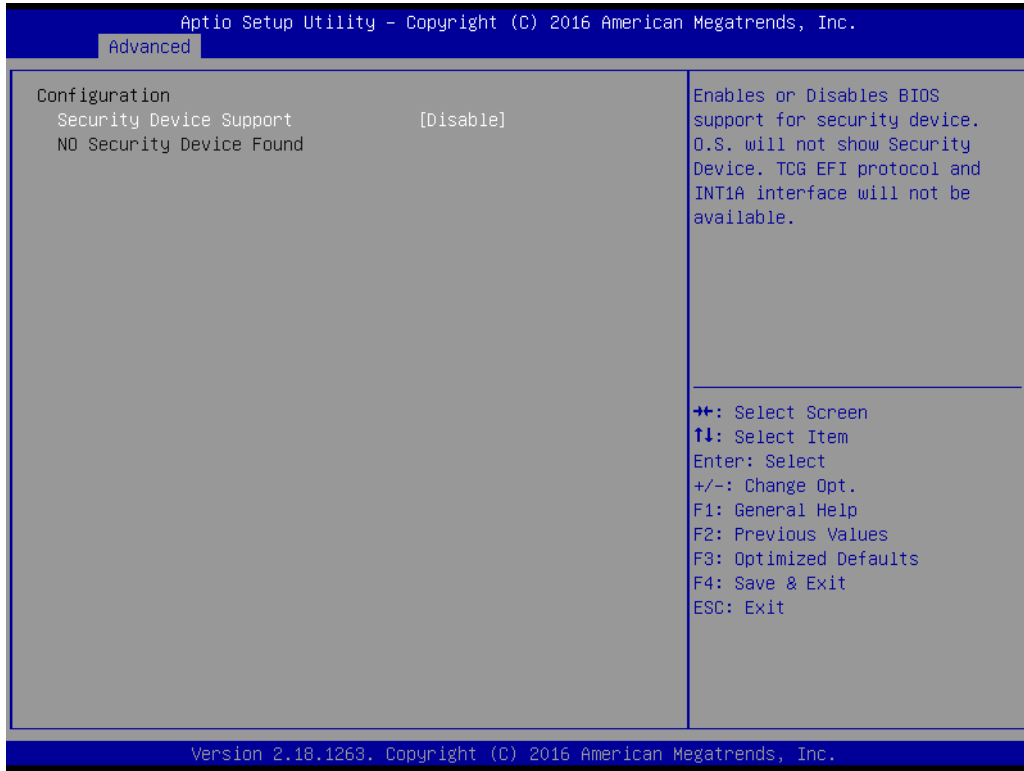

Figure 3.17 TPM Settings

- **TPM Support**
 "Enable" or "Disable" TPM Support. You can purchase Advantech the LPC TPM module to enable the TPM function. P/N: PCA-TPM-00B1E.

3.2.2.7 ACPI Settings

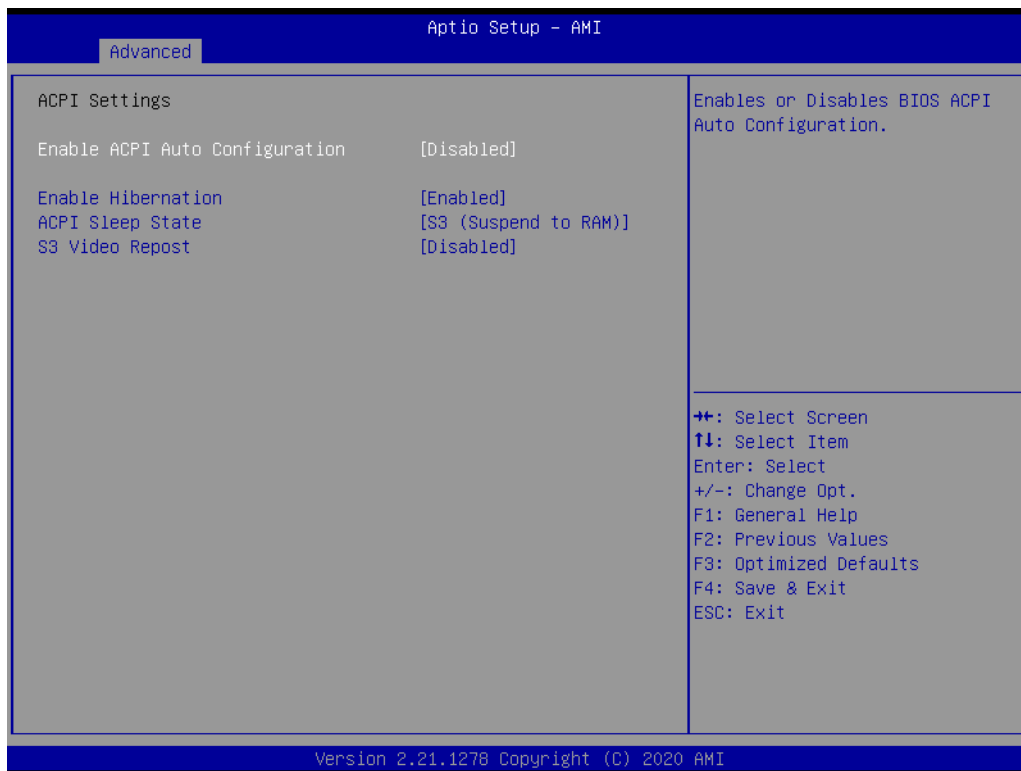

Figure 3.18 ACPI Settings

- **Enable ACPI Auto Configuration**
"Enable" or "Disable" ACPI auto configuration.
- **Enable Hibernation**
"Enable" or "Disable" Hibernation (OS/S4 Sleep State). This option may not be applied in some OS.
- **ACPI Sleep State**
"Auto" or "S1 only" or "S3 only" ACPI Sleep State.
- **S3 Video Repost**
"Enable" or "Disable" S3 Video Repost.

3.2.2.8 SMART Settings

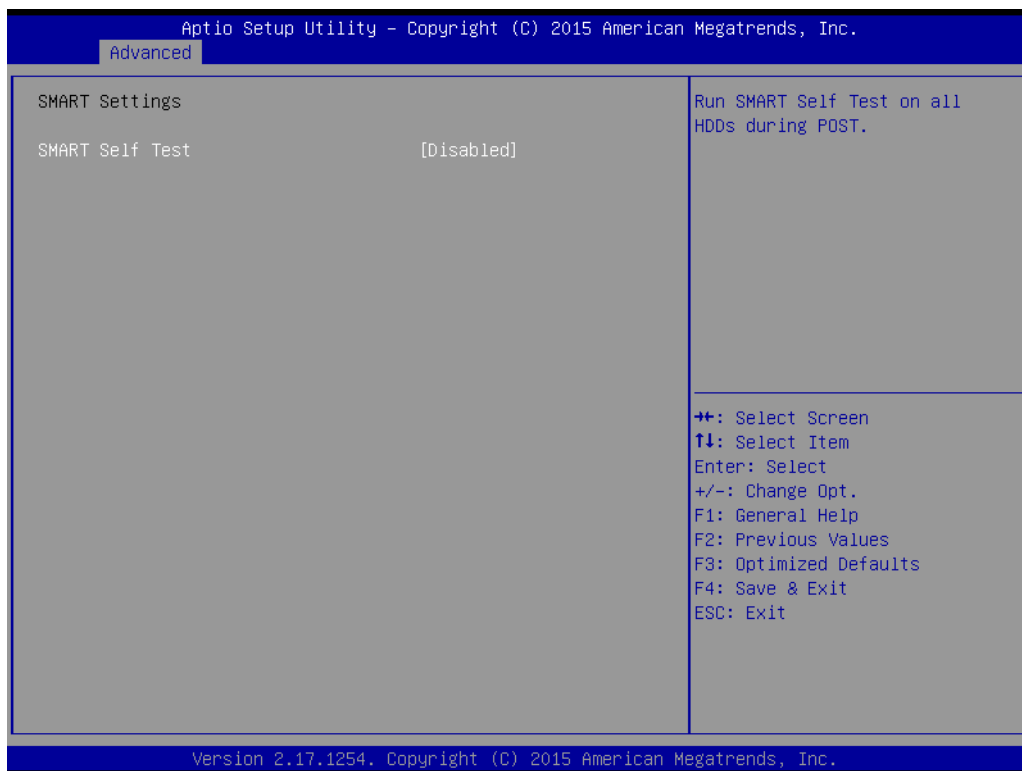

Figure 3.19 SMART Settings

- **SMART Self Test**
"Enable" or "Disable" SMART Self Test on all HDDs during POST.

3.2.2.9 Super IO Configuration

MIC-770 V3 supports 2 x RS-232/422/485 on the front side. MIC-770 has 4 more RS-232 (Serial Port 3, 4, 5, 6) via 2x DB9 cables in the accessory box.



Figure 3.20 Super IO Configuration

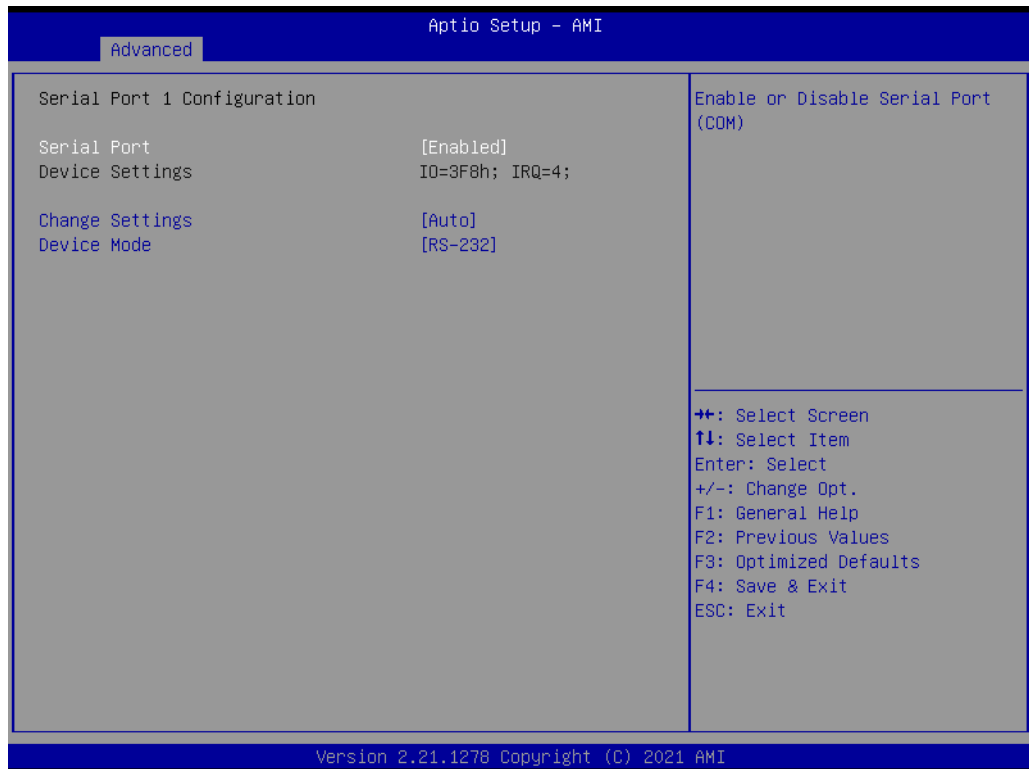

Figure 3.21 Serial Port 1 Configuration

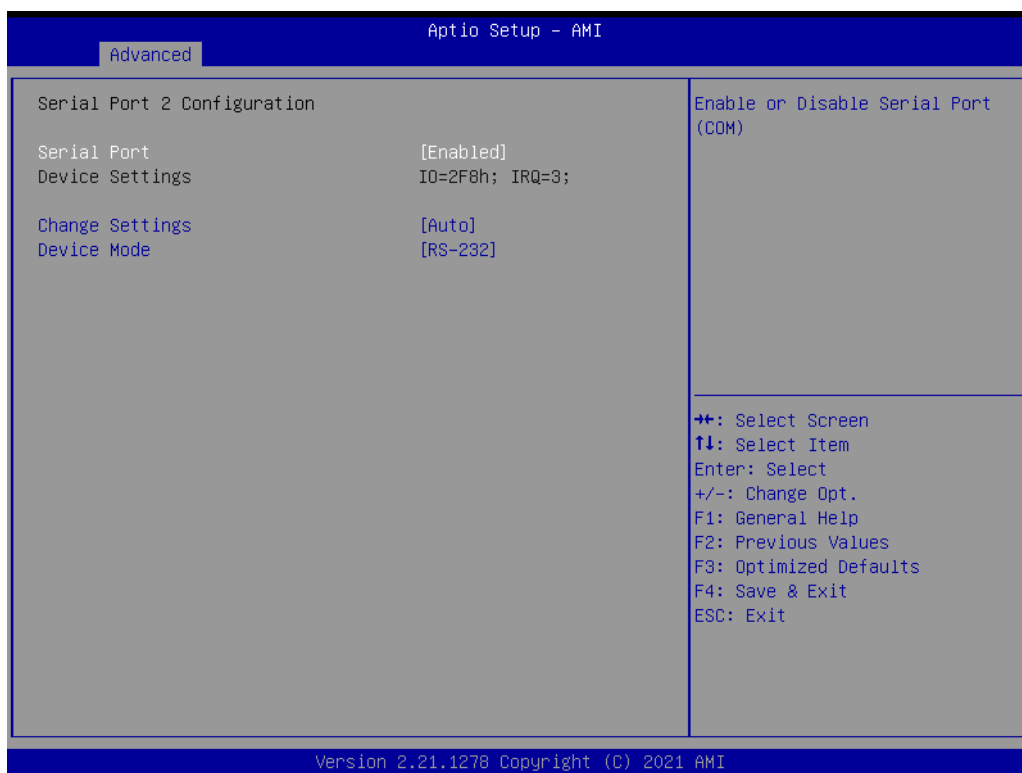

Figure 3.22 Serial Port 2 Configuration

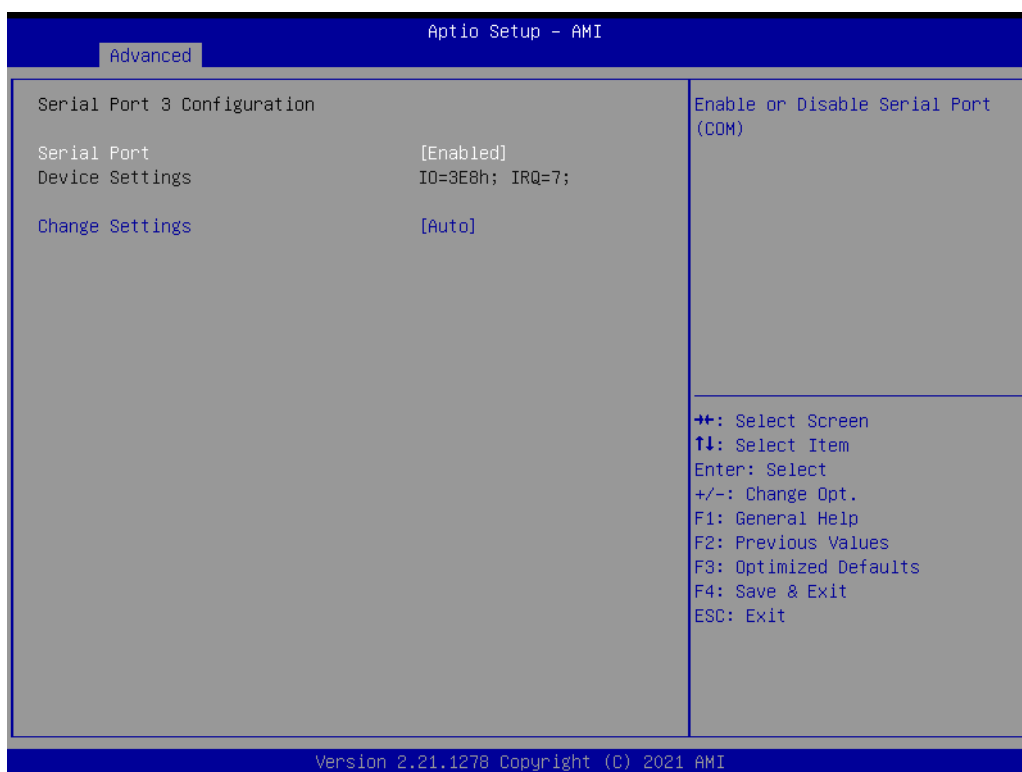

Figure 3.23 Serial Port 3 Configuration

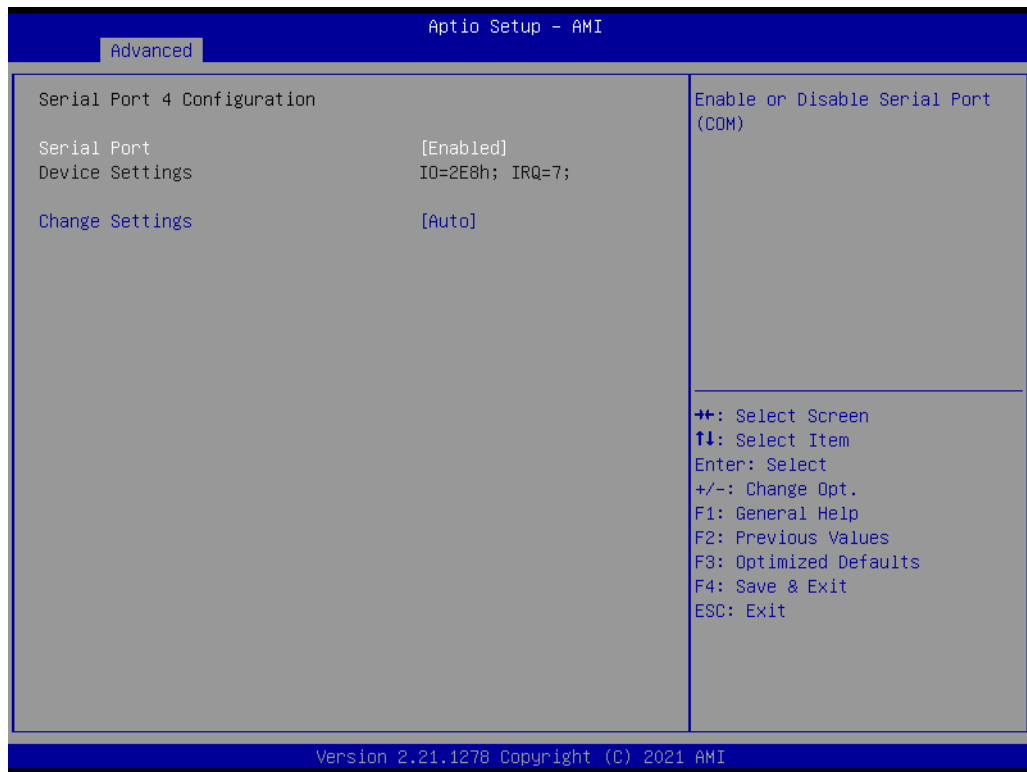

Figure 3.24 Serial Port 4 Configuration

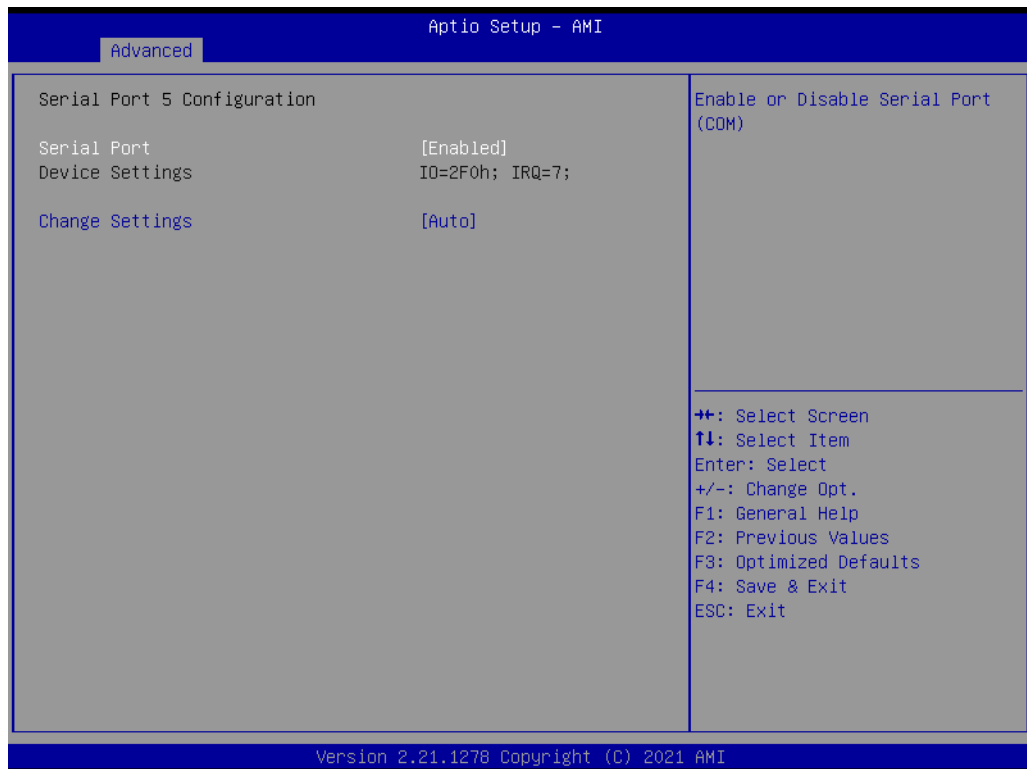

Figure 3.25 Serial Port 5 Configuration

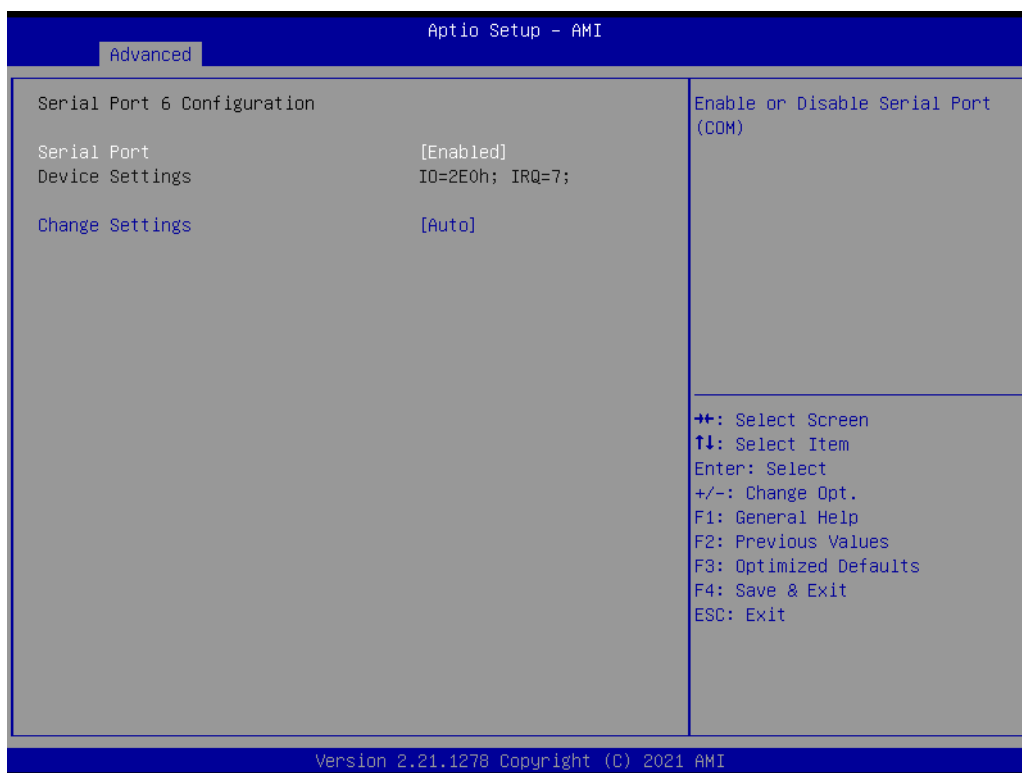

Figure 3.26 Serial Port 6 Configuration

- **Serial Port 1 Configuration**
 - **Serial Port**
"Enable" or "Disable" Serial Port 1.
 - **Change Settings**
Select an optimal setting for serial port 1.
- **Serial Port 2 Configuration**
 - **Serial Port**
"Enable" or "Disable" Serial Port 2.
 - **Change Settings**
Select the optimal setting for serial port 2.
- **Serial Port 3-6 Configuration**
 - **Serial Port**
This item allows users to disable or enable the Serial Port.
 - **Change Settings**
This item allows users to change settings of the serial ports. The default setting is Auto.

3.2.2.10 H/W Monitor

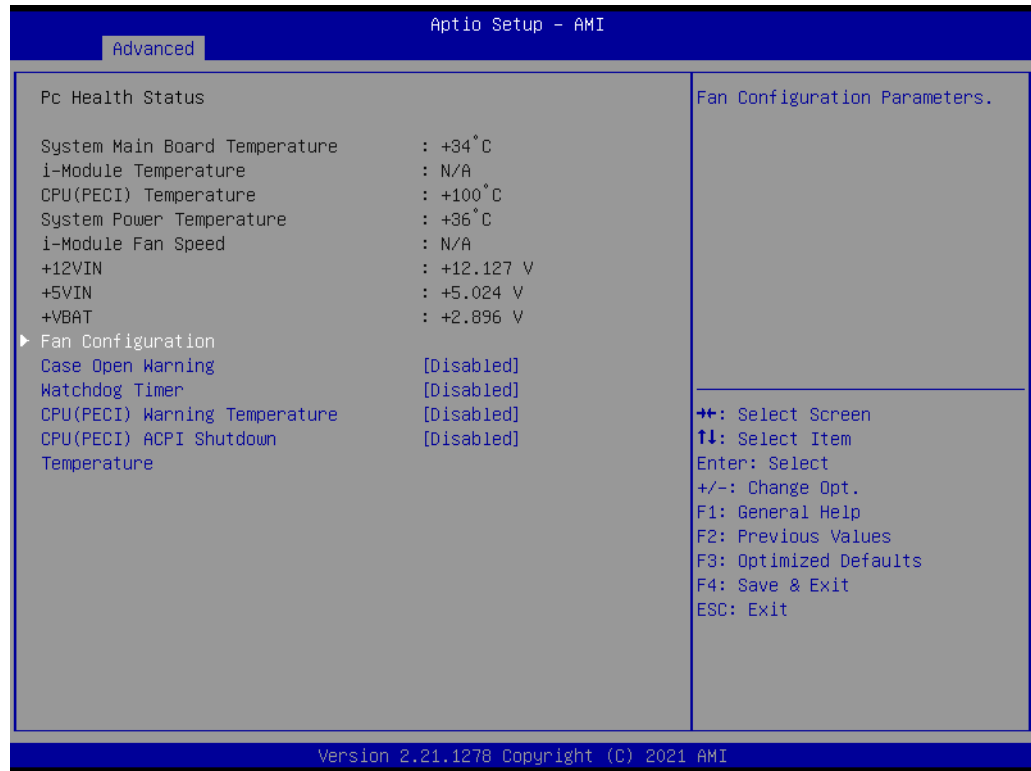
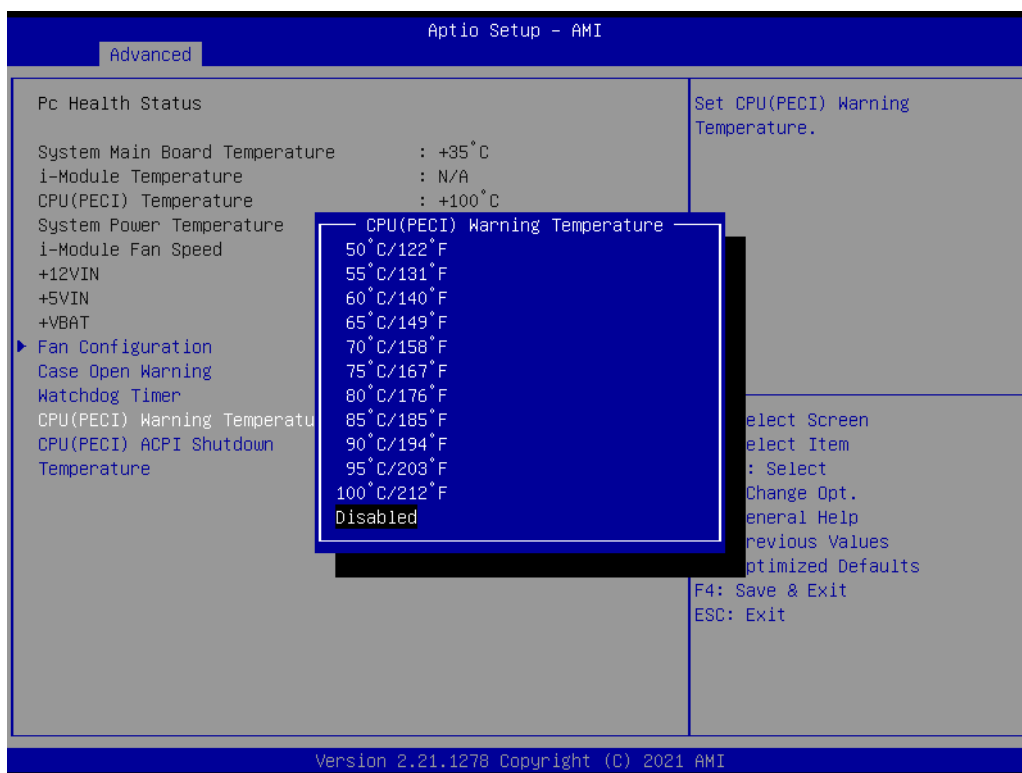

Figure 3.27 PC Health Status

- **Case Open Warning**
"Enable" or "Disable" the Chassis Intrusion monitoring function. When it is enabled and the case is opened, the speaker beeps.
- **CPU (PECI) Warning Temperature**
Use this item to set the CPU warning temperature. When the system reaches the warning temperature, the speaker will beep.



■ ACPI (PECI) Shutdown Temperature

Use this item to set the ACPI shutdown temperature. When the system reaches the shutdown temperature, it will be automatically shut down by ACPI OS to protect the system from overheating damage.

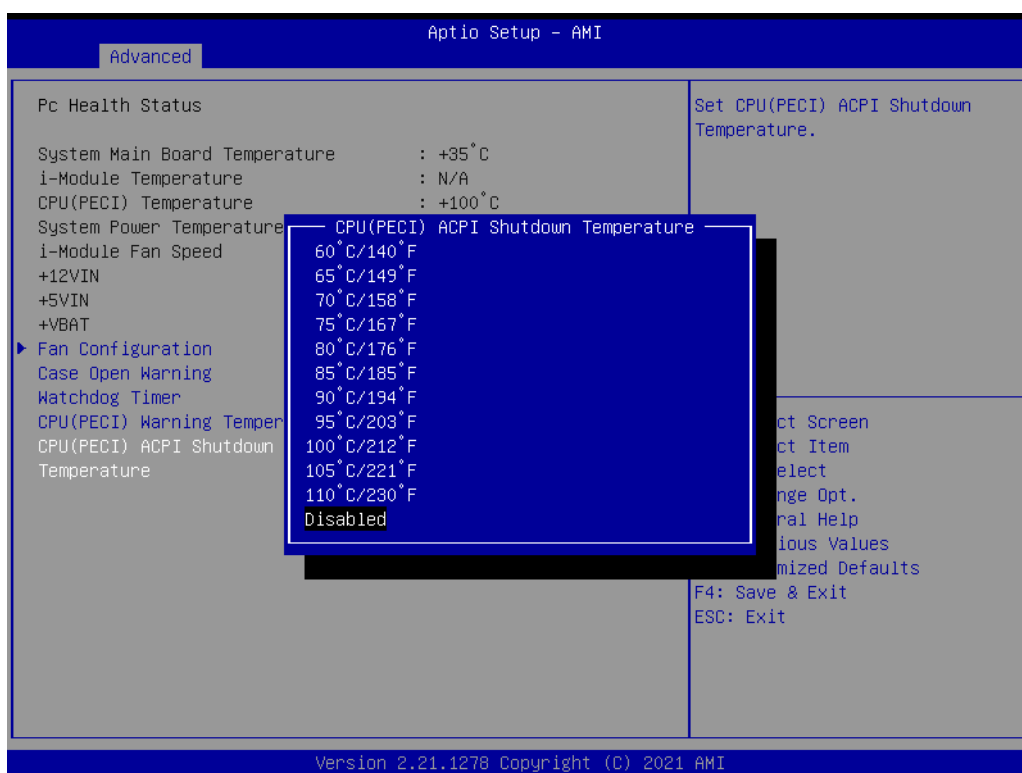

■ Fan Configuration

To select Manual Mode or SmartFan Mode of the i-Module FAN

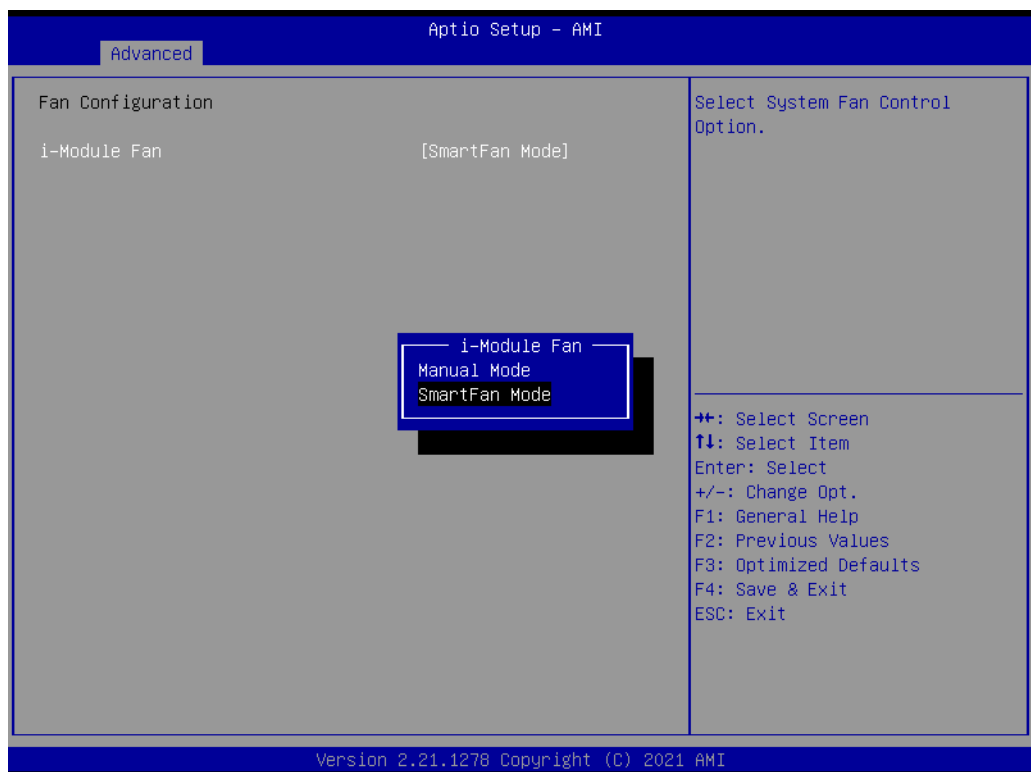
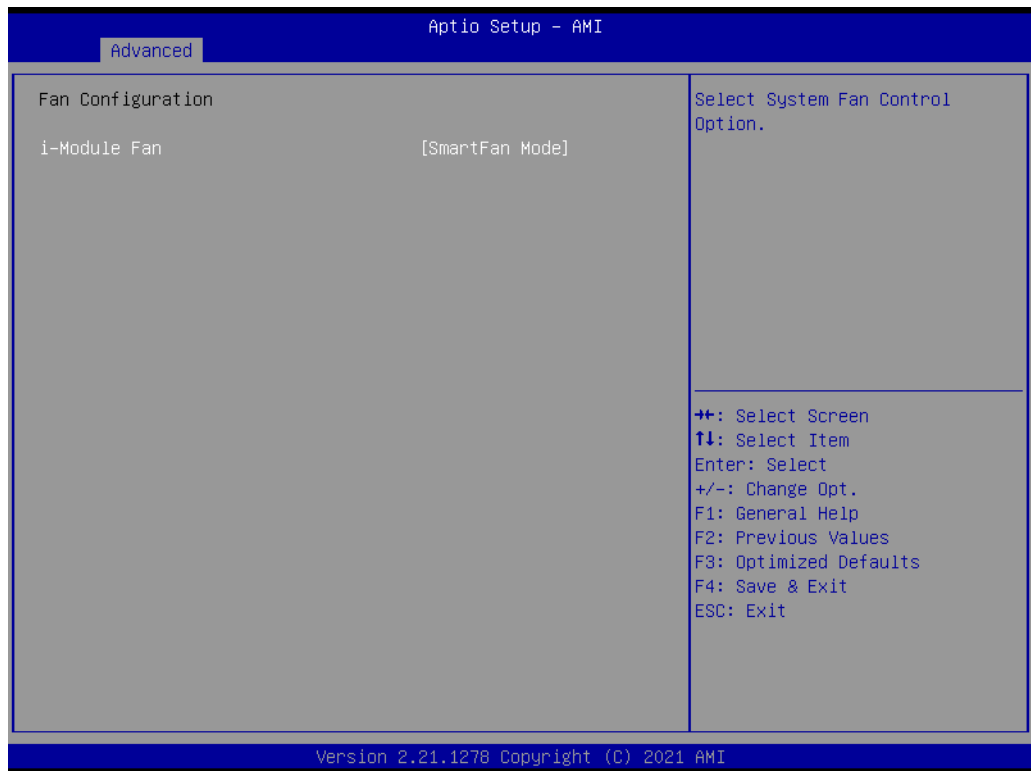

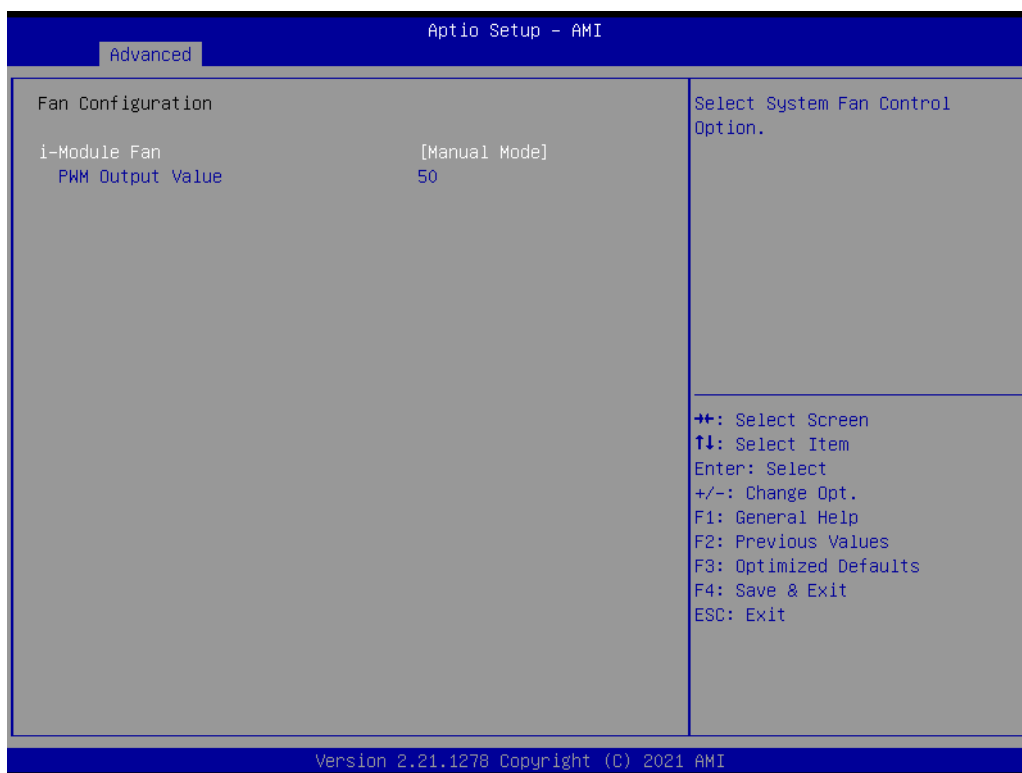

3.2.2.11 S5 RTC Wake Settings

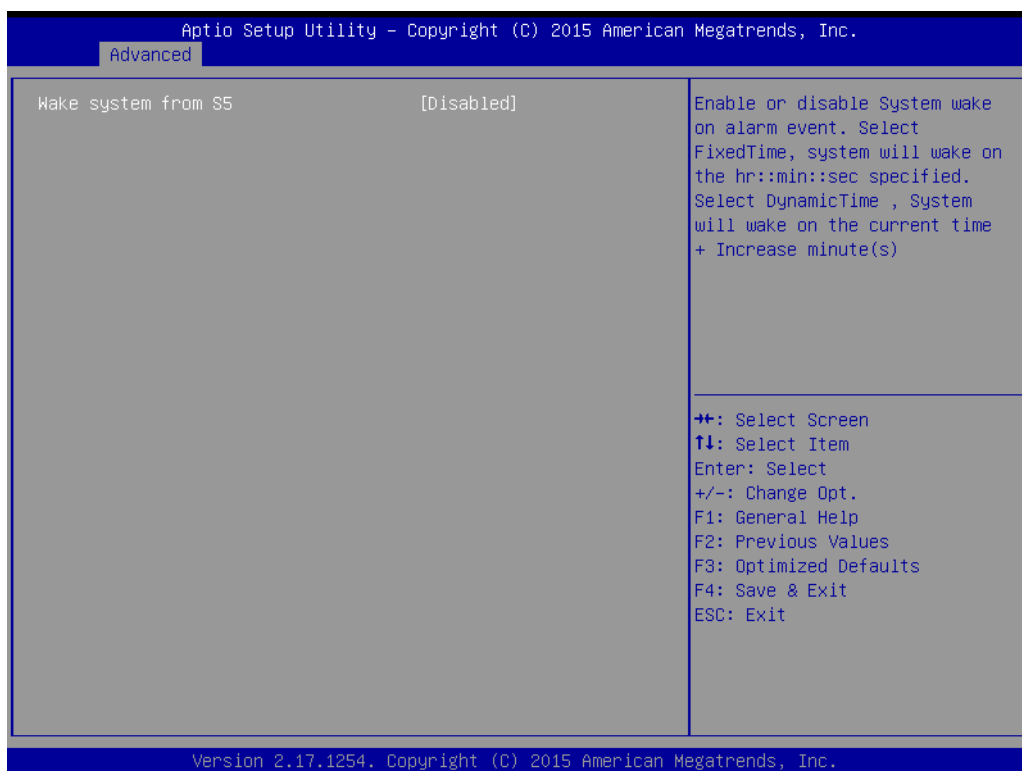

Figure 3.28 S5 RTC Wake Settings

- Wake system with Fixed Time**
 "Enable" or "Disable" System wake on alarm event. The system will wake on the hr:min:sec as specified.

3.2.2.12 Serial Port Console Redirection

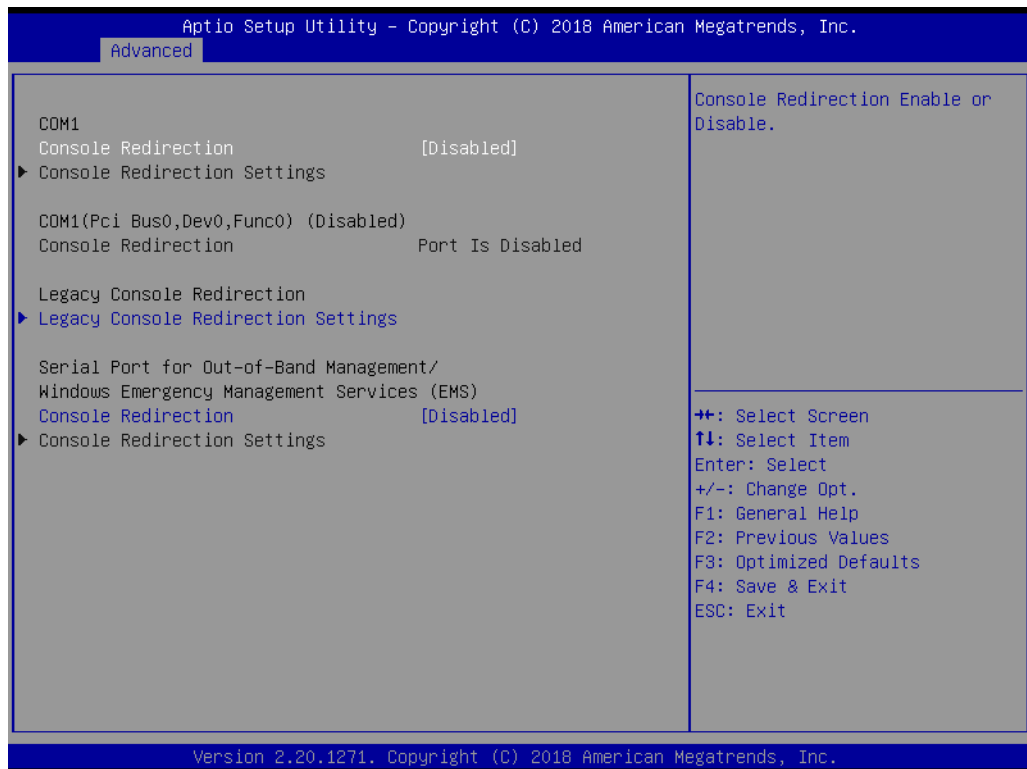

Figure 3.29 Serial Port Console Redirection



Figure 3.30 Legacy Console Redirection Settings

- **COM1**
 - **Console Redirection Settings**
Console Redirection "Enable" or "Disable".

- **Legacy Console Redirection**
 - **Legacy Console Redirection Settings**
Select a COM port to display redirection of Legacy OS and Legacy OPRM Messages.
- **Serial Port for Out-of-Band Management/ Windows Emergency Management services (EMS)**
 - **Console Redirection Settings**
Console Redirection "Enable" or "Disable".

3.2.2.13 Intel® TXT Information

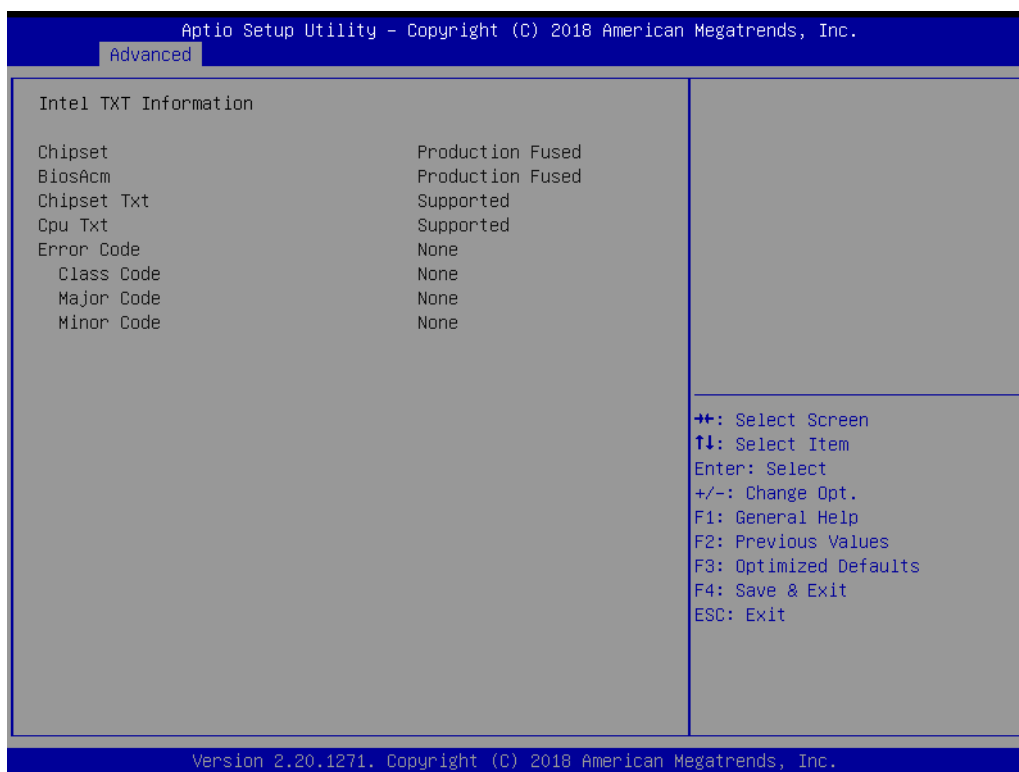

Figure 3.31 Intel® TXT Information

3.2.2.14 USB Configuration

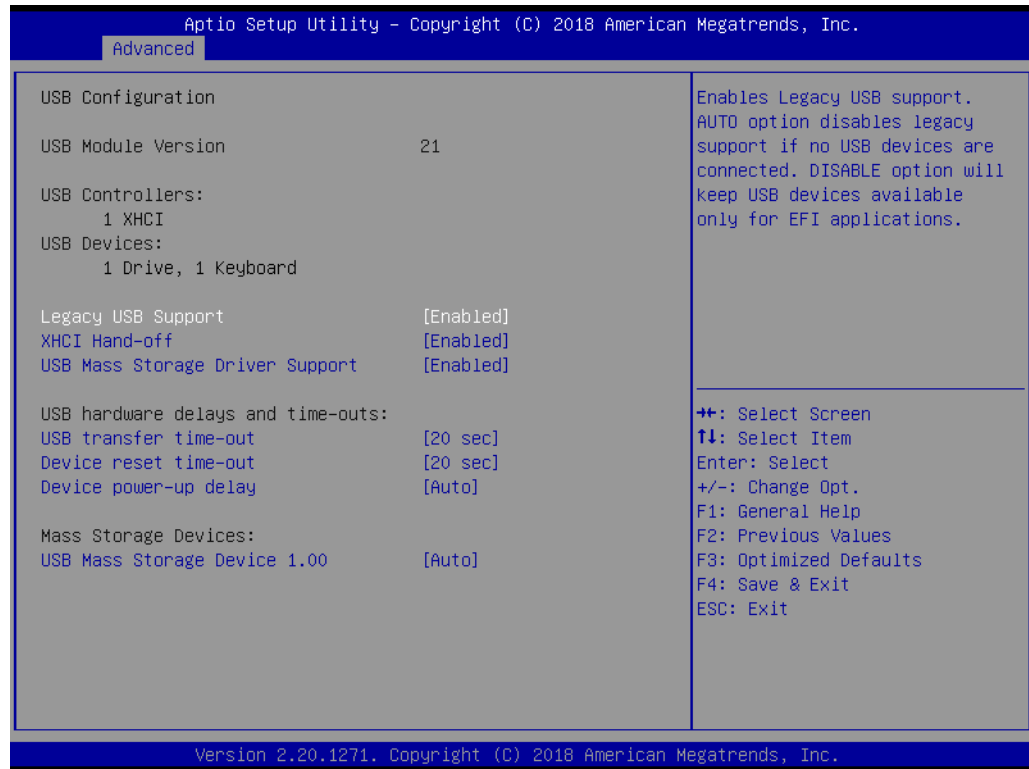

Figure 3.32 USB Configuration

- **Legacy USB Support**

This is for supporting USB devices under legacy OS such as DOS. When choosing "AUTO", the system will automatically detect if any USB device is plugged into the computer and enable USB legacy mode when a USB device is plugged in and disable USB legacy mode when no USB device is plugged in.
- **XHCI Hand-off**

This is a workaround for OS without XHCI hand-off support. The XHCI ownership change should be claimed by the XHCI driver.
- **USB Mass Storage Driver Support**

"Enable" or "Disable" USB Mass Storage driver support.
- **USB transfer time-out**

Allows you to select the USB transfer time-out value. [1, 5, 10, 20 sec]
- **Device reset time-out**

Allows you to select the USB device reset time-out value. [10, 20, 30, 40 sec]
- **Device power-up delay**

Maximum time the device will take before it properly reports itself to the Host Controller. "Auto" uses the default value: for a Root port it is 100 ms, for a Hub port the delay is taken from the Hub descriptor.
- **Mass Storage Devices**

Mass storage device emulation type. "Auto" enumerates devices according to their media format. Optical drives are emulated as "CD-ROM" drives with no media and will be emulated according to a drive type.

3.2.2.15 Network Stack Configuration



Figure 3.33 Network Stack Configuration

- **Network Stack**
"Enable" or "Disable" UEFI Network Stack.

3.2.2.16 CSM Configuration



Figure 3.34 CSM Configuration

- **Compatibility Support Module Configuration**

- **CSM Support**

- "Enable" or "Disable" CSM Support. The default setting is "Disabled". If your graphics card does not support UEFI mode, make sure to select "Enabled" to allow non-UEFI boot mode before installing the graphics card to turn on the computer.

3.2.2.17 NVMe Configuration



Figure 3.35 NVMe Configuration

- **NVMe Configuration**
NVMe M.2 storage device is supported.

3.2.3 Chipset



Figure 3.36 Chipset

This page provides information for the chipset on MIC-770 V3.

3.2.3.1 System Agent (SA) Configuration

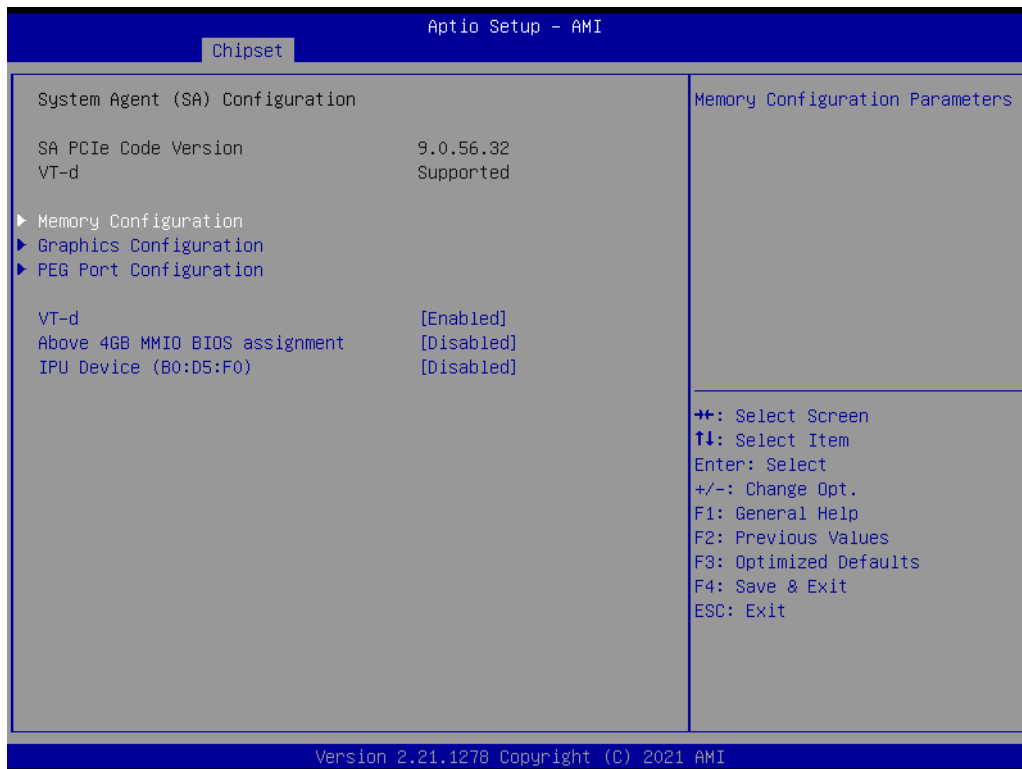

Figure 3.37 System Agent (SA) Configuration

- **VT-d**
"Enable" or "Disable" the VT-d function.
- **Above 4GB MMIO BIOS assignment**
"Enable" or "Disable" above 4GB Memory Mapped IO BIOS assignment.
- **IPU Device (B0:D5:F0)**
"Enable" or "Disable" SA IPU device.

3.2.3.2 Memory Configuration

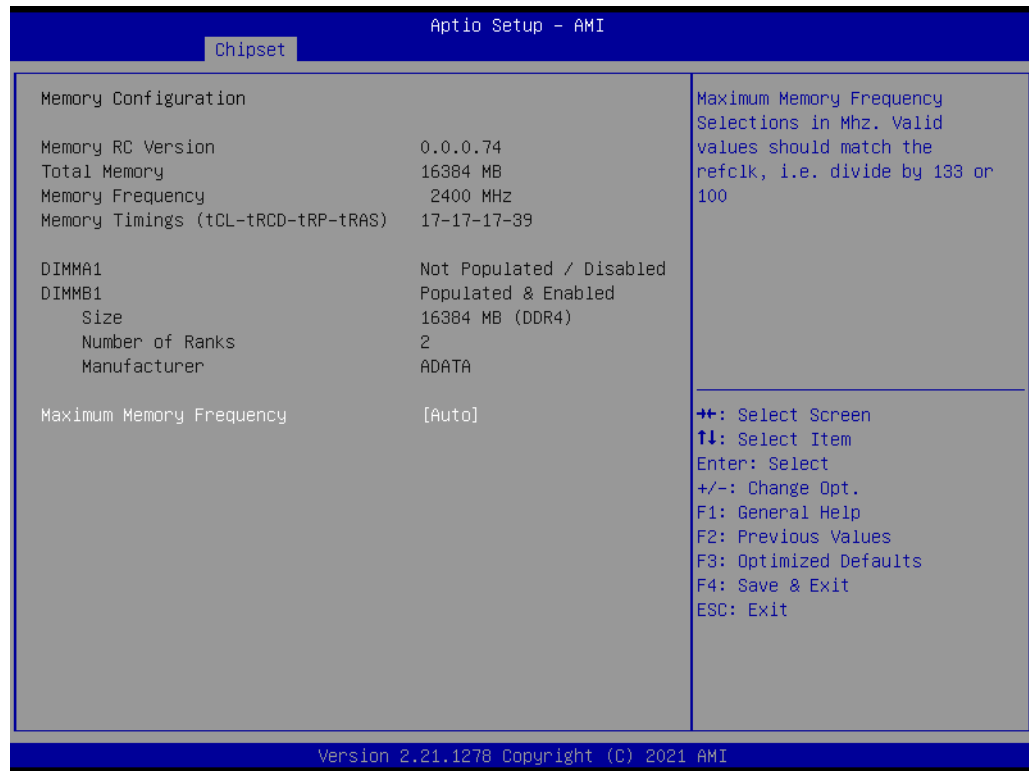

Figure 3.38 Memory Configuration

- **Maximum Memory Frequency**
Maximum memory frequency selections in MHz.

3.2.3.3 Graphics Configuration



Figure 3.39 Graphics Configuration

- **Primary Display**
Set Primary Display to "Auto", "IGFX", "PEG", "PCI", or "SG".
- **Internal Graphics**
Set Internal Graphics to "Auto", "Disable", or "Enable". "Auto" will disable internal graphics when a GPU card is installed. If GPU and internal graphics outputs are required at the same time, set this item to "Enable".

3.2.3.4 PEG Port Configuration

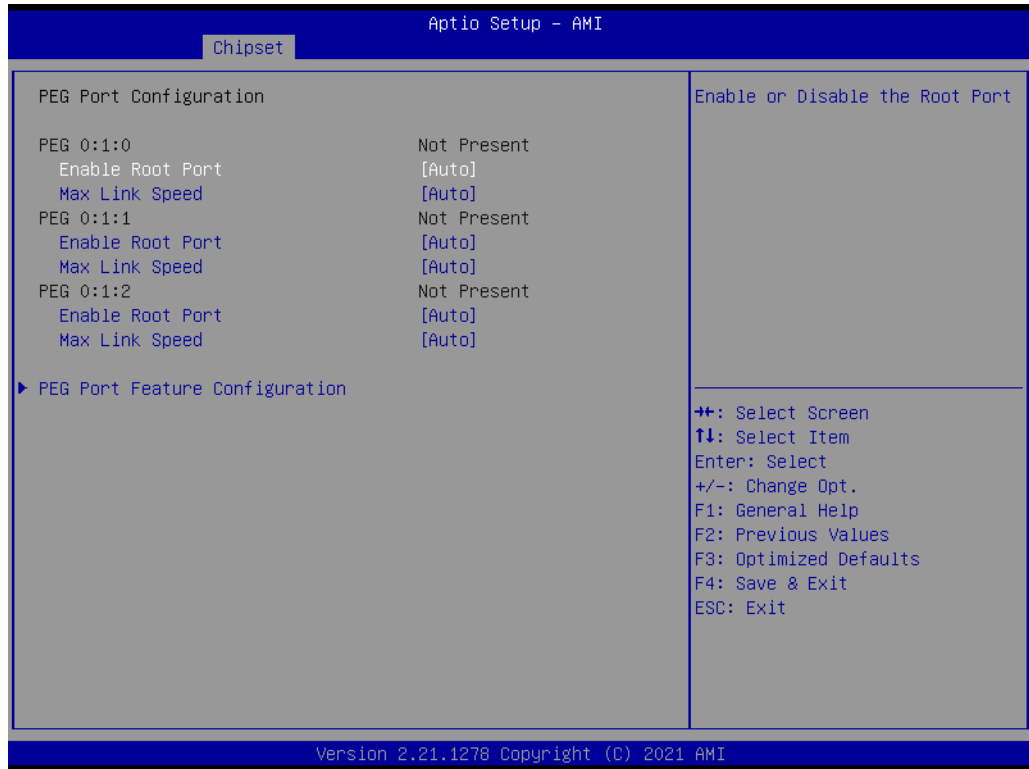

Figure 3.40 PEG Port Configuration

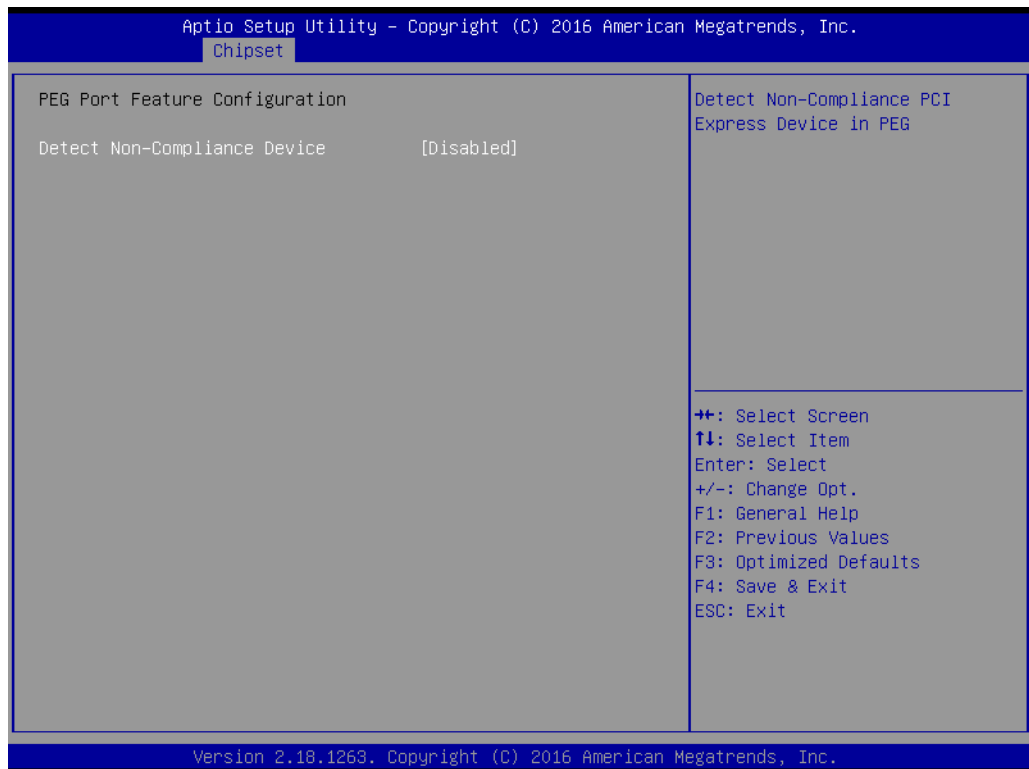

Figure 3.41 PEG Port Feature Configuration

- **Enable Root Port**
"Enable" or "Disable" the root port.
- **Max Link speed**
Configure PEG 0:1:0 max speed.

- **PEG Port Feature Configuration**
 - **Detect Non-Compliance Device**
Detect non-compliance PCI Express devices in PEG. If enabled, it will take more time during POST.

3.2.3.5 PCH-IO Configuration

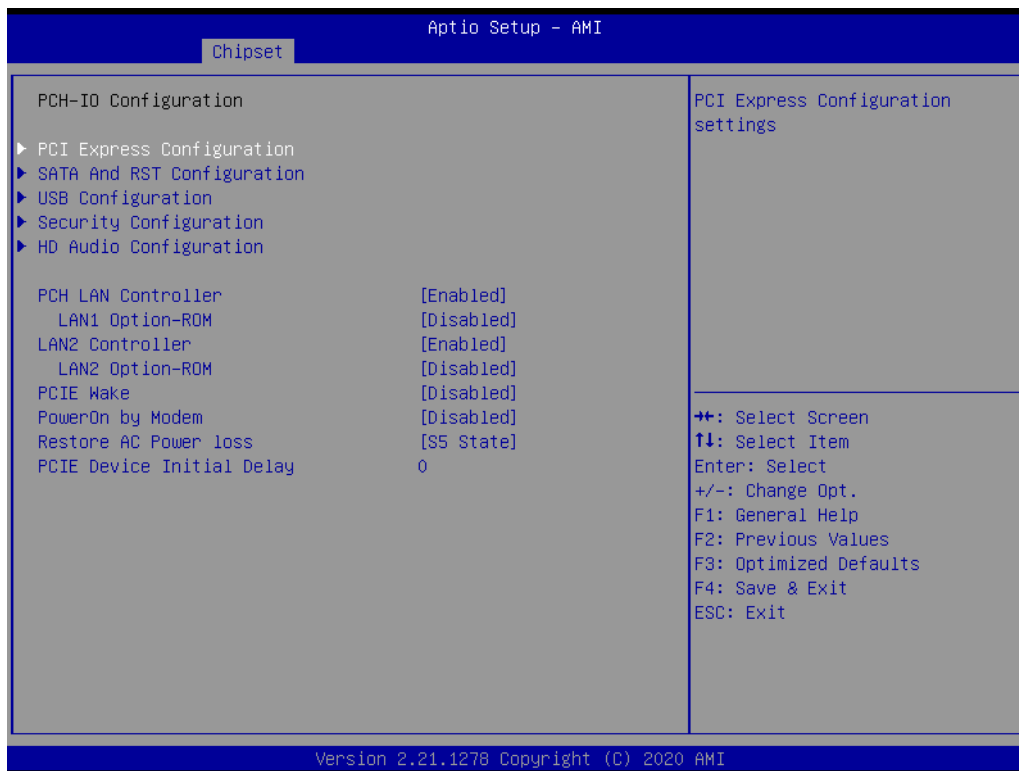

Figure 3.42 PCH-IO Configuration

- **LAN1 Controller**
"Enable" or "Disable" the LAN1 controller.
- **LAN1 Option-ROM**
"Enable" or "Disable" the LAN1 boot option for legacy network devices.
- **LAN2 Controller**
"Enable" or "Disable" the LAN2 controller.
- **LAN2 Option-ROM**
"Enable" or "Disable" the LAN2 boot option for legacy network devices.
- **PCIE Wake**
"Enable" or "Disable" PCIE to wake the system from S5. When this item is selected as "Disabled", the Wake-on-LAN2 function is also disabled.
- **PowerOn by Modem**
"Enable" and "Disable" PowerOn by Modem.
- **Restore AC Power Loss**
Behavior when recovering from AC power loss: "S0" (power on), "S5" (power off), or "Last State".
- **PCIE Device Initial Delay**
Users can set a number of seconds to delay the PCIE device initial time.

3.2.3.6 PCI Express Configuration

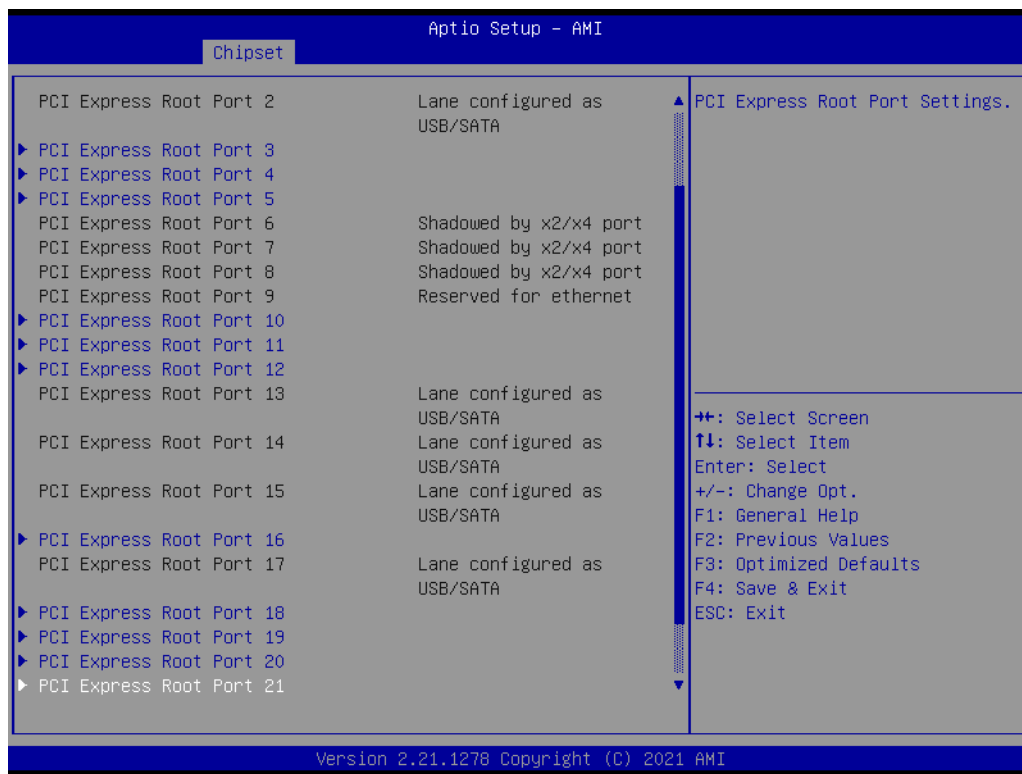
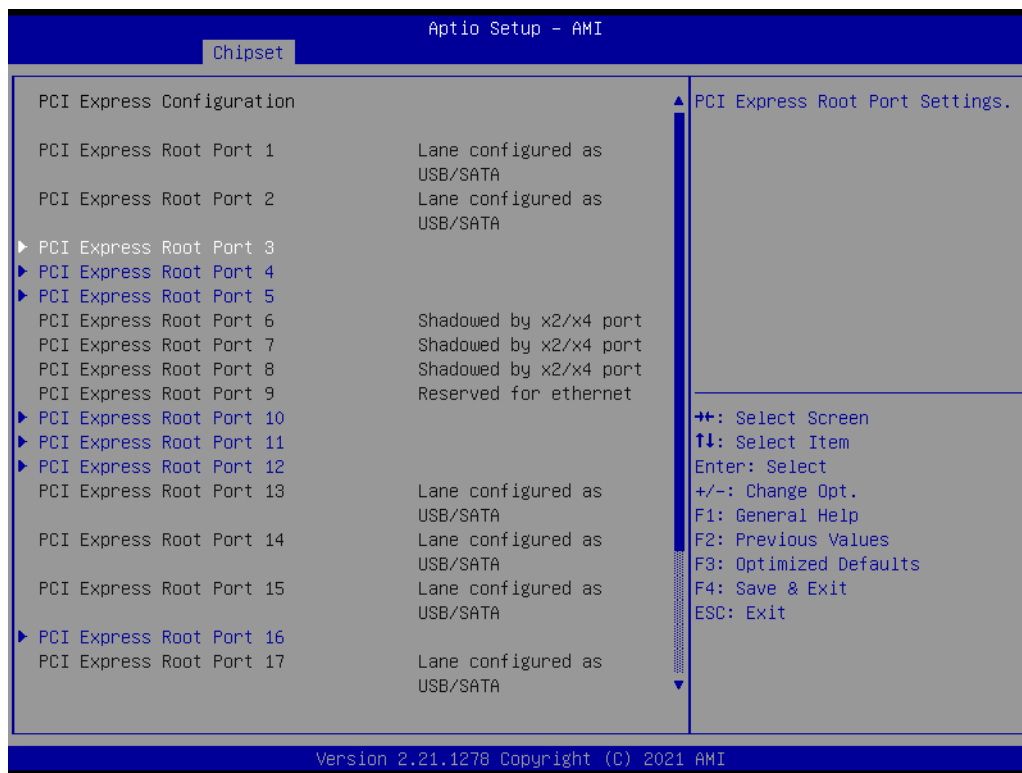

Figure 3.43 PCI Express Configuration

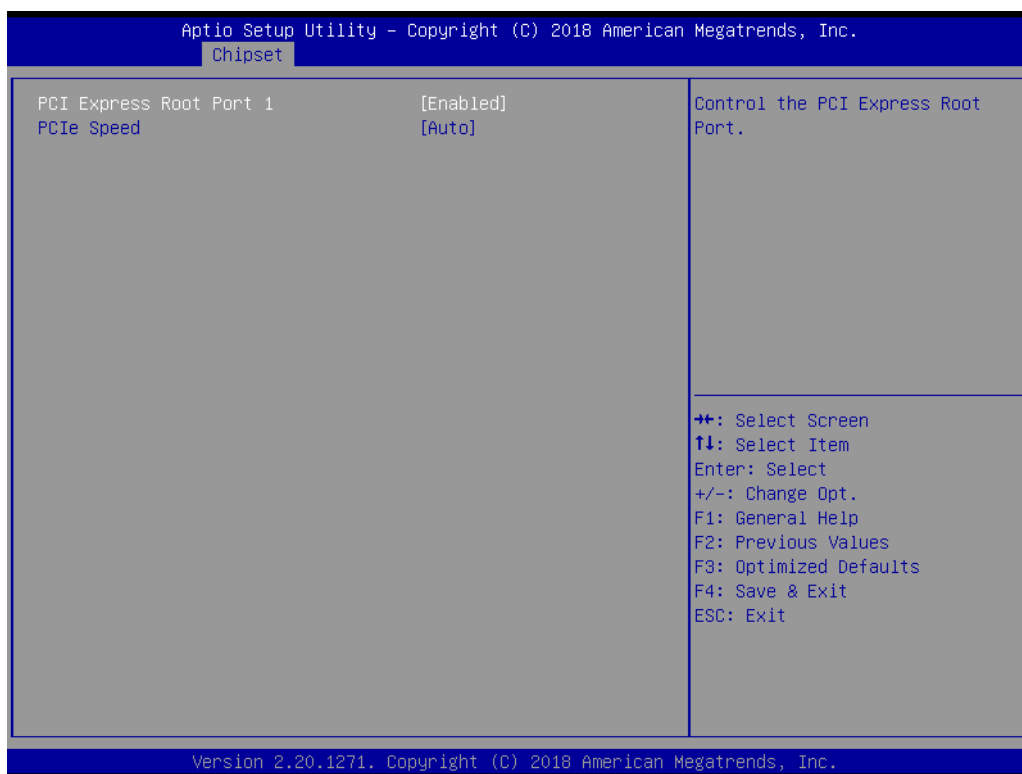

Figure 3.44 PCI Express Root Port

- **PCI Express Root Port 1**
"Enable" or "Disable" PCI Express Root Port.
- **PCIe Speed**
Select "Auto", "Gen1", "Gen2", or "Gen 3" for PCIe Speed.

3.2.3.7 SATA and RST Configuration



Figure 3.45 SATA and RST Configuration

- **SATA Controller(s)**
"Enable" or "Disable" the SATA controller.
- **SATA Mode Selection**
This can be configured as "RAID" or "AHCI".
- **Port 1~4**
"Enable" or "Disable" SATA ports 1~4.
- **Hot Plug**
"Enable" or "Disable" SATA Hot-Plug.
- **Spin Up Device**
"Enable" or "Disable" the spin up device.
- **SATA Device Type**
To identify if SATA is connected to a "Solid State Drive" or "Hard Disk Drive".

3.2.3.8 USB Configuration



Figure 3.46 USB Configuration

- **XHCI Compliance Mode**
Option to "Enable" or "Disable" XHCI compliance mode. The default is to disable compliance mode.

3.2.3.9 Security Configuration

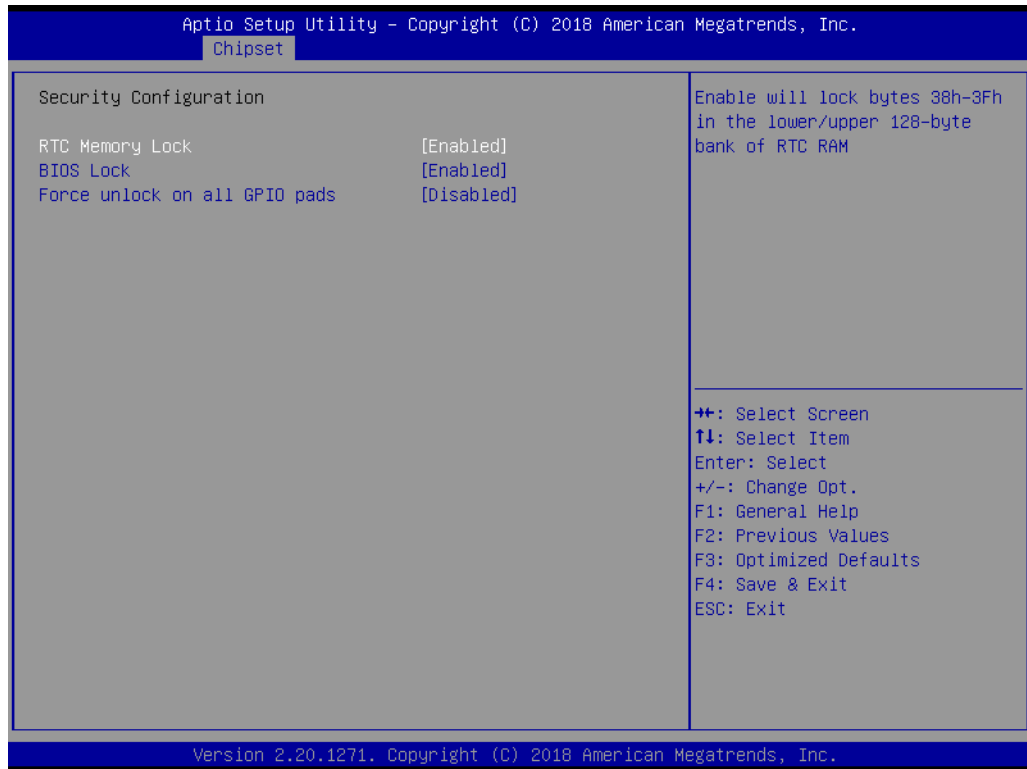

Figure 3.47 Security Configuration

- **RTC Memory Lock**
"Enable" will lock bytes 38h-3Fh in the lower/upper 128-byte bank of RTC RAM.
- **BIOS Lock**
"Enable" or "Disable" the PCH BIOS Lock Enable feature. It is required to be enabled to ensure SMM protection of flash.
- **Force unlock on all GPIO pads**
If enabled, BIOS will force all GPIO pads to be in an unlocked state.

3.2.3.10 HD Audio Configuration



Figure 3.48 HD Audio Configuration

- **HD Audio**
 Control detection of the HD-Audio device.
 Disable = HDA will be unconditionally disabled.
 Enable=HDA will be unconditionally enabled.

3.2.4 Security

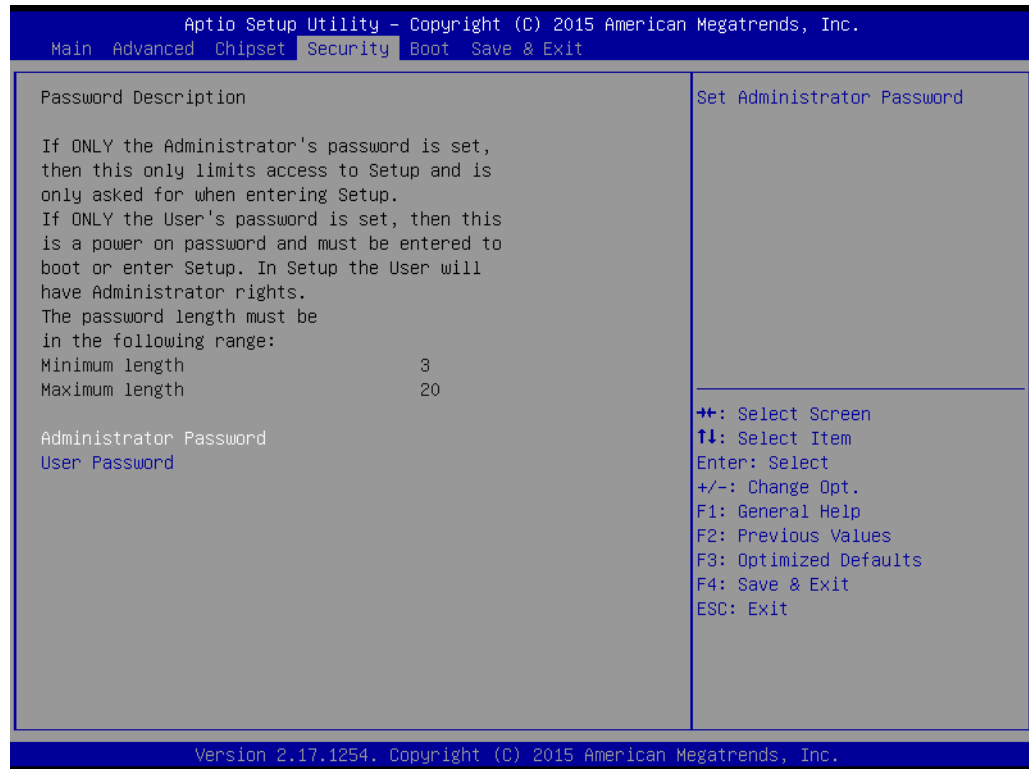

Figure 3.49 Security

Select Security Setup from the MIC-770 V3 Setup main BIOS setup menu. All Security Setup options, such as password protection are described in this section. To access the sub-menu for the following items, select the item and press <Enter>.

Note! *If only the User's password is set, the User will have Administrator rights. To set the Administrator password, it is strongly recommended that you take thorough security precautions.*



3.2.5 Boot

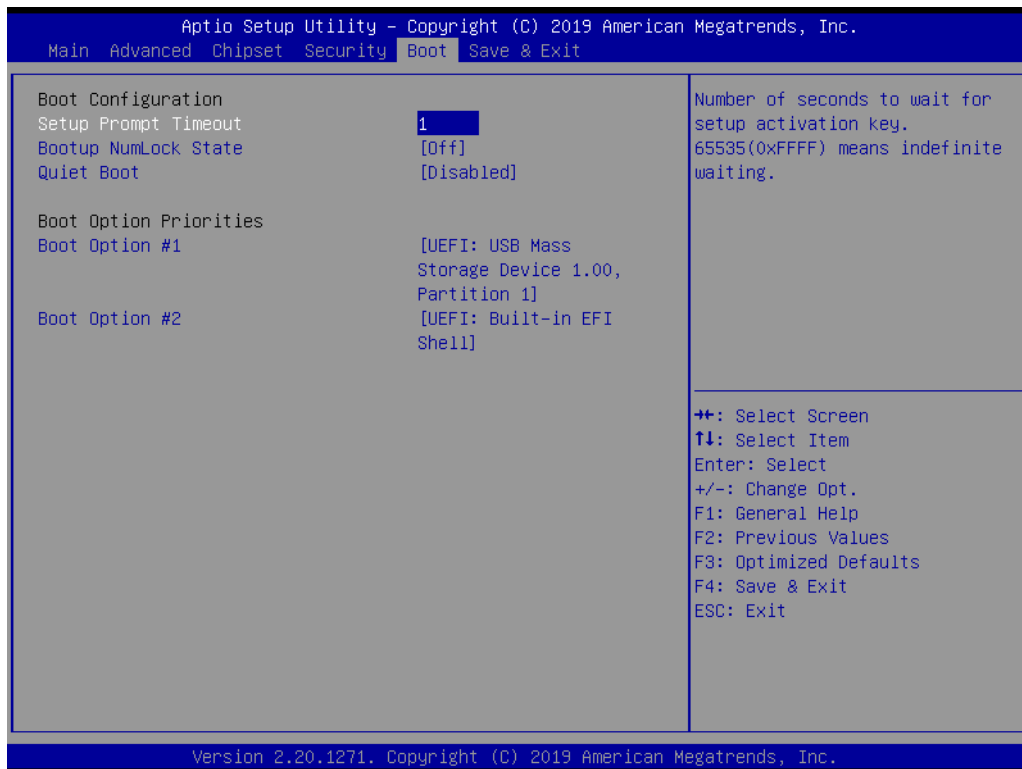

Figure 3.50 Boot

- **Setup Prompt Timeout**
Directly key in the number, or use the <+> and <-> keys to adjust the number of seconds to wait for the setup activation key.
- **Bootup NumLock State**
Default state for the NumLock key during power on.
- **Quiet Boot**
"Enable" or "Disable" the Quiet Boot option. When enabled, the BIOS logo will show in place of the POST screen.
- **Boot Option Priorities**
Set the boot order.

3.2.6 Save & Exit

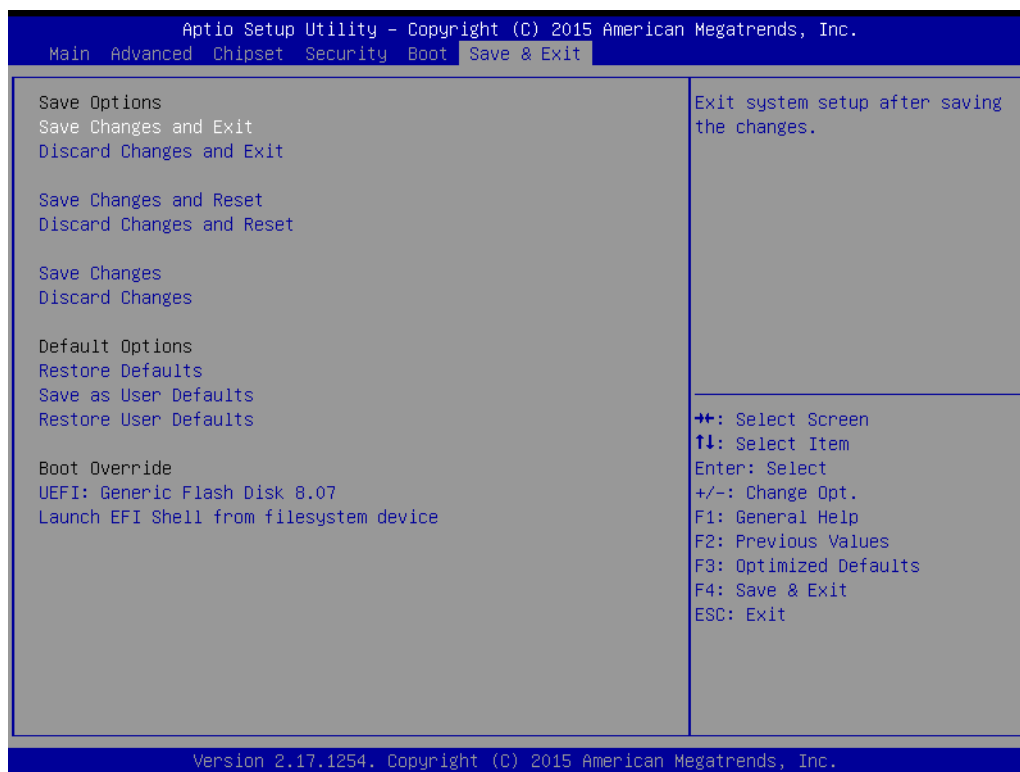

Figure 3.51 Save & Exit

Save Changes and Exit

When you complete system configuration, select this option to save your changes, exit BIOS setup and reboot the computer so the new system configuration parameters can take effect.

1. Select Exit Saving Changes from the Exit menu and press <Enter>. The following message appears:
Save Configuration Changes and Exit Now?
[Yes] [No]
2. Select Yes or No.

Discard changes and exit

Select this option to quit Setup without making any permanent changes to the system configuration.

1. Select Exit Discarding Changes from the Exit menu and press <Enter>. The following message appears:
Quit without saving?
[Yes] [No]
2. Select Yes to discard changes and exit.

Discard Changes

Select Discard Changes from the Exit menu and press <Enter>.

Chapter 4

Software Installation

This chapter covers driver installation.

4.1 Before you begin

To facilitate the installation of the enhanced display drivers and utility software, read the instructions in this chapter carefully. The drivers for the MIC-770 V3 are located on the Advantech support website (<http://www.advantech.com/support>). Updates are provided via Service Packs from Microsoft.

Note! For system stability, installing the drivers in the following sequence is highly recommended:



- Chipset
- Graphics
- ME
- Other drivers

Before you begin, it is important to note that most display drivers need to have the relevant software application already installed in the system prior to installing the enhanced display drivers. In addition, many of the installation procedures assume that you are familiar with both the relevant software applications and operating system commands. Review the relevant operating system commands and the pertinent sections of your application software's user manual before performing the installation.

4.2 Introduction

The Intel® Chipset Software Installation (CSI) utility installs the Windows INF files that outline to the operating system how the chipset components will be configured. This is needed for the proper functioning of the following features:

- Core PCI PnP services
- Serial ATA interface support
- Identification of Intel chipset components in the Device Manager.

Note! The chipset driver is used for the following versions of Windows, and it has to be installed before installing all the other drivers:



- Windows 10 (64-bit)

4.3 Windows Driver Setup

Enter the Advantech support website, then search for MIC-770 V3. You can find the graphics drivers for MIC-770 V3 inside.

Chapter 5

Integrated Graphics
Device Setup

5.1 Introduction

The Intel® processors are embedded with an integrated graphics controller. You need to install the VGA driver to enable this function. This driver provides the graphics, compute, media, and display capabilities.

5.2 Windows Driver Setup

Note! *Before installing this driver, make sure the INF driver has been installed in your system. See Chapter 4 for information on installing the INF driver.*



Enter the Advantech support website, then search for MIC-770 V3. You can find the "Graphics" driver inside.

Chapter 6

Intel[®] ME

6.1 Introduction

The Intel® ME software components that need to be installed depend on the system's specific hardware and firmware features. The installer detects the system's capabilities and installs the relevant drivers and applications.

6.2 Installation

Enter the Advantech support website, then search for MIC-770 V3. You can find the "ME" drivers there.

Chapter 7

LAN Configuration

7.1 Introduction

The MIC-770 V3 has dual Gigabit Ethernet LANs via dedicated PCI Express x1 lanes (Intel® I219LM (LAN1) and I210IT (LAN2)). These offer bandwidth of up to 500 MB/sec, thus eliminating network data flow bottlenecks, and incorporating Gigabit Ethernet at 1000 Mbps.

7.2 Features

- 10/100/1000Base-T Ethernet controller
- 10/100/1000Base-T triple-speed MAC
- Full duplex at 10, 100, or 1000 Mbps and half duplex at 10 or 100 Mbps
- Wake-on-LAN (WOL) support
- PCIe x1 host interface

7.3 Installation

Note! *Before installing the LAN drivers, make sure the CSI utility has been installed on your system. See Chapter 4 for information on installing the CSI utility.*



The integrated Intel® gigabit Ethernet controller supports all major network operating systems. However, the installation procedure varies with different operating systems. In the following sections, refer to the one that provides the driver setup procedure for the operating system you are using.

7.4 Windows Driver Setup

Enter the Advantech support website, then search for MIC-770 V3. You can find the "LAN" driver inside.

Chapter 8

SATA RAID Setup

8.1 Introduction

The Intel® R680E chipset integrates 4 x Serial ATA controllers with software RAID 0, 1, 5, 10 capabilities to support the demands of disk I/O.

RAID 0 striping increases storage performance and is designed to speed up data transfer rates for disk-intensive applications.

RAID 1 mirroring protects valuable data that might be lost in the event of a hard drive failure.

RAID 5 array contains three or more hard drives where the data is divided into manageable blocks called strips. Parity is a mathematical method for recreating data that was lost from a single drive, which increases fault-tolerance. The data and parity are striped across all the hard drives in the array. The parity is striped in a rotating sequence to reduce bottlenecks associated with the parity calculations.

The RAID 10 array uses four hard drives to create a combination of RAID levels 0 and 1. The data is striped across a two-drive array forming the RAID 0 component. Each of the drives in the RAID 0 array is then mirrored by a RAID 1 component.

8.2 SATA RAID Driver and Utility Setup

Enter the Advantech support website, then search for MIC-770 V3. You can see the "Others" folder containing the RST driver.

Chapter 9

HD Audio

9.1 Introduction

MIC-770 V3 is equipped with a Realtek ALC888S audio chip. It provides "Line-out" & "Microphone" ports for diverse applications.

9.2 Installation

Enter the Advantech support website, then search for MIC-770 V3. This is where users can find the "Audio" drivers.

Appendix **A**

Programming the
Watchdog Timer

A.1 Programming the Watchdog Timer

The MIC-770 V3's watchdog timer can be used to monitor system software operation and take corrective action if the software fails to function within the programmed period. This section describes the operation of the watchdog timer and how to program it.

A.1.1 Watchdog Timer Overview

The watchdog timer is built into the super I/O controller NCT6126D. It provides the following user-programmable functions:

- It can be enabled and disabled by user configuration.
- The timer can be set from 1 to 255 seconds or 1 to 255 minutes.
- It generates an interrupt or reset signal if the software fails to reset the timer before time-out.

A.1.2 Programming the Watchdog Timer

The I/O port address of the watchdog timer is 2E (hex) and 2F (hex). 2E (hex) is the address port. 2F (hex) is the data port. You must first assign the address of register by writing an address value into address port 2E (hex), then write/read data to/from the assigned register through data port 2F (hex).

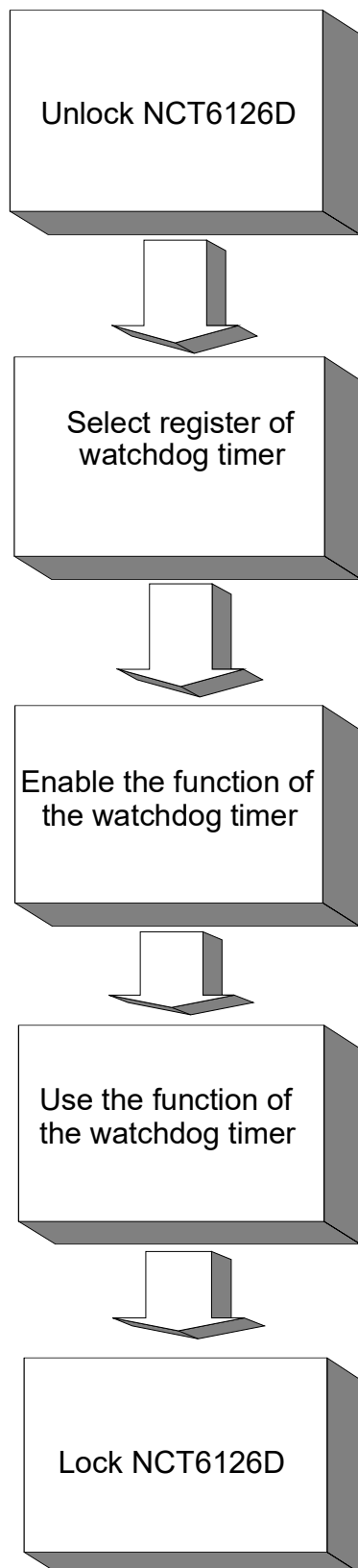

Table A.1: Watchdog Timer Registers

Address of Register (2E) Attribute		
Read/Write	Value (2F) & description	
87 (hex)	-----	Write this address to I/O address port 2E (hex) twice to unlock the NCT6126D.
07 (hex)	write	Write 08 (hex) to select register of watchdog timer.
30 (hex)	write	Write 01 (hex) to enable the function of the watchdog timer. Disabled is set as default.
F0 (hex)	write	Set seconds or minutes as units for the timer. Write 0 to bit 3: set second as counting unit. [default] Write 1 to bit 3: set minutes as counting unit.
F1 (hex)	write	0: stop timer [default] 01~FF (hex): The amount of the count, in seconds or minutes, depends on the value set in register F5 (hex). This number decides how long the watchdog timer waits for the strobe before generating an interrupt or reset signal. Writing a new value to this register can reset the timer to count with the new value.
F2 (hex)	read/write	Bit 7: Write 1 to enable the mouse to reset the timer, 0 to disable [default]. Bit 6: Write 1 to enable the keyboard to reset the timer, 0 to disable. [default] Bit 5: Write 1 to generate a timeout signal immediately and automatically return to 0. [default=0] Bit 4: Read status of the watchdog timer, 1 means the timer is in "timeout".
AA (hex)	-----	Write this address to I/O port 2E (hex) to lock the watchdog timer 2.

A.1.3 Example Program

1. Enable watchdog timer and set 10 sec. as timeout interval.

```

;-----
Mov dx,2eh ; Unlock NCT6126D
Mov al,87h
Out dx,al
Out dx,al
;-----
Mov al,07h ; Select register of the watchdog timer.
Out dx,al
Inc dx
Mov al,08h
Out dx,al
;-----
Dec dx ; Enable the function of the watchdog timer.
Mov al,30h
Out dx,al
Inc dx
Mov al,01h
Out dx,al
;-----
Dec dx ; Set seconds as the counting unit.
Mov al,0f0h
Out dx,al
Inc dx
In al,dx
And al,not 08h
Out dx,al
;-----
Dec dx ; Set timeout interval as 10 seconds and start counting.
Mov al,0f1h
Out dx,al
Inc dx
Mov al,10
Out dx,al
;-----
Dec dx ; Lock NCT6126D
Mov al,0aah
Out dx,al

```

2. Enable the watchdog timer and set 5 minutes as the timeout interval.

```

;-----
Mov dx,2eh ; Unlock NCT6126D
Mov al,87h
Out dx,al
Out dx,al

```

```

;-----
Mov al,07h ; Select register of the watchdog timer.
Out dx,al
Inc dx
Mov al,08h
Out dx,al
;-----
Dec dx ; Enable the function of watchdog timer.
Mov al,30h
Out dx,al
Inc dx
Mov al,01h
Out dx,al
;-----
Dec dx ; Set minutes as the counting unit.
Mov al,0f0h
Out dx,al
Inc dx
In al,dx
Or al,08h
Out dx,al
;-----
Dec dx ; Set the timeout interval as 5 minutes and start counting.
Mov al,0f1h
Out dx,al
Inc dx
Mov al,5
Out dx,al
;-----
Dec dx ; Lock NCT6126D
Mov al,0aah
Out dx,al
3. Enable the watchdog timer to be reset by mouse.
;-----
Mov dx,2eh ; Unlock NCT6126D
Mov al,87h
Out dx,al
Out dx,al
;-----
Mov al,07h ; Select register of the watchdog timer.
Out dx,al
Inc dx
Mov al,08h
Out dx,al
;-----

```



```

Dec dx ; Enable the function of the watchdog timer.
Mov al,30h
Out dx,al
Inc dx
Mov al,01h
Out dx,al
;-----
Dec dx ; Enable the watchdog timer to be reset by mouse.
Mov al,0f2h
Out dx,al
Inc dx
In al,dx
Or al,80h
Out dx,al
;-----
Dec dx ; Lock NCT6126D
Mov al,0aah
Out dx,al
4. Enable the watchdog timer to be reset by keyboard.
;-----
Mov dx,2eh ; Unlock NCT6126D
Mov al,87h
Out dx,al
Out dx,al
;-----
Mov al,07h ; Select register of the watchdog timer.
Out dx,al
Inc dx
Mov al,08h
Out dx,al
;-----
Dec dx ; Enable the function of the watchdog timer.
Mov al,30h
Out dx,al
Inc dx
Mov al,01h
Out dx,al
;-----
Dec dx ; Enable the watchdog timer to be strobe reset by keyboard.
Mov al,0f2h
Out dx,al
Inc dx
In al,dx
Or al,40h
Out dx,al

```

```

;-----
Dec dx ; Lock NCT6126D
Mov al,0aah
Out dx,al
5. Generate a time-out signal without timer counting.
;-----
Mov dx,2eh ; Unlock NCT6126D
Mov al,87h
Out dx,al
Out dx,al
;-----
Mov al,07h ; Select register of the watchdog timer.
Out dx,al
Inc dx
Mov al,08h
Out dx,al
;-----
Dec dx ; Enable the function of the watchdog timer.
Mov al,30h
Out dx,al
Inc dx
Mov al,01h
Out dx,al
;-----
Dec dx ; Generate a time-out signal
Mov al,0f2h
Out dx,al ;Write 1 to bit 5 of F7 register
Inc dx
In al,dx
Or al,20h
Out dx,al
;-----
Dec dx ; Lock NCT6126D
Mov al,0aah
Out dx,al

```

Appendix **B**

Programming the
GPIO

B.1 Supported GPIO Register

The following is a description of the GPIO addresses and programming sample.

B.1.1 GPIO Registers

GPIO 1

CRF0 (GP10-GP17 I/O selection register. Default 0xFF)

When set to '1', the respective GPIO port is programmed as an input port.

When set to '0', the respective GPIO port is programmed as an output port.

CRF1 (GP10-GP17 data register. Default 0x00)

If a port is programmed to be an output port, then its respective bit can be read/written.

If a port is programmed to be an input port, then its respective bit can only be read.

CRF2 (GP10-GP17 inversion register. Default 0x00)

When set to '1', the incoming/outgoing port value is inverted.

When set to '0', the incoming/outgoing port value is the same as in the data register.

GPIO 0

CREC (GP00-GP07 I/O selection register. Default 0xFF)

When set to '1', the respective GPIO port is programmed as an input port.

When set to '0', the respective GPIO port is programmed as an output port.

CREC (GP00-GP07 data register. Default 0xFF)

If a port is programmed to be an output port, then its respective bit can be read/written.

If a port is programmed to be an input port, then its respective bit can only be read.

CREE (GP00-GP07 inversion register. Default 0x00)

When set to '1', the incoming/outgoing port value is inverted.

When set to '0', the incoming/outgoing port value is the same as in the data register.

Extended Function Index Registers (EFIRs)

The EFIRs are write-only registers with port address 2Eh or 4Eh on PC/AT systems.

Extended Function Data Registers (EFDRs)

The EFDRs are read/write registers with port address 2Fh or 4Fh on PC/AT systems.

B.1.2 GPIO Example Program

 Enter the extended function mode, interruptible double-write

```
MOV DX, 2EH
MOV AL, 87H
OUT DX, AL
OUT DX, AL
```

 Configure logical device 7(GP10~GP17), configuration register CRE4,CRE5,CRE6

```
MOV DX, 2EH
MOV AL, 07H ; Point to Logical Device Number Reg.
OUT DX, AL
MOV DX, 2FH
MOV AL, 07H ; Select logical device 7
OUT DX, AL
```

 Configure GPIO1 I/O Register

```
MOV DX, 2EH
MOV AL, ECH
OUT DX, AL
MOV DX, 2FH
MOV AL, ??H ; 0: The respective GPIO1 PIN is programmed as an output port
              ;1: The respective GPIO1 PIN is programmed as an input port.
OUT DX, AL
```

 Configure GPIO1 Inversion Register

```
MOV DX, 2EH
MOV AL, EEH
OUT DX, AL
MOV DX, 2FH
MOV AL, 00H ; Set GPIO is normal not inverter
OUT DX, AL
```

 Configure GPIO1 Data Register

```
MOV DX, 2EH
MOV AL, EDH
OUT DX, AL
MOV DX, 2FH
MOV AL, ??H ; Put the output value into AL
OUT DX, AL
```

Exit extended function mode

```
MOV DX, 2EH
MOV AL, AAH
OUT DX, AL
```

ADVANTECH

Enabling an Intelligent Planet

www.advantech.com

Please verify specifications before quoting. This guide is intended for reference purposes only.

All product specifications are subject to change without notice.

No part of this publication may be reproduced in any form or by any means, such as electronically, by photocopying, recording, or otherwise, without prior written permission from the publisher.

All brand and product names are trademarks or registered trademarks of their respective companies.

© Advantech Co., Ltd. 2023