

**AMI230
AMI231
AMI232**
High Performance Fanless System

User's Manual

Version 1.0
(April 2020)



Copyright

© 2020 IBASE Technology, Inc. All rights reserved.

No part of this publication may be reproduced, copied, stored in a retrieval system, translated into any language or transmitted in any form or by any means, electronic, mechanical, photocopying, or otherwise, without the prior written consent of IBASE Technology, Inc. (hereinafter referred to as "IBASE").

Disclaimer

IBASE reserves the right to make changes and improvements to the products described in this document without prior notice. Every effort has been made to ensure the information in the document is correct; however, IBASE does not guarantee this document is error-free. IBASE assumes no liability for incidental or consequential damages arising from misapplication or inability to use the product or the information contained herein, nor for any infringements of rights of third parties, which may result from its use.

Trademarks

All the trademarks, registrations and brands mentioned herein are used for identification purposes only and may be trademarks and/or registered trademarks of their respective owners.

Compliance

CE

This product has passed CE tests for environmental specifications and limits. This product is in accordance with the directives of the Union European (EU). If users modify and/or install other devices in this equipment, the CE conformity declaration may no longer apply.

FCC

This product has been tested and found to comply with the limits for a Class B device, pursuant to Part 15 of the FCC Rules. These limits are designed to provide reasonable protection against harmful interference in a residential installation. This equipment generates, uses and can radiate radio frequency energy and, if not installed and used in accordance with manufacturer's instructions, may cause harmful interference to radio communications.

WEEE



This product must not be disposed of as normal household waste, in accordance with the EU directive of for waste electrical and electronic equipment (WEEE - 2012/19/EU). Instead, it should be disposed of by returning it to a municipal recycling collection point. Check local regulations for disposal of electronic products.

Green IBASE



This product is compliant with the current RoHS restrictions and prohibits use of the following substances in concentrations exceeding 0.1% by weight (1000 ppm) except for cadmium, limited to 0.01% by weight (100 ppm).

- Lead (Pb)
- Mercury (Hg)
- Cadmium (Cd)
- Hexavalent chromium (Cr6+)
- Polybrominated biphenyls (PBB)
- Polybrominated diphenyl ether (PBDE)

Important Safety Information

Carefully read the precautions before using the device.

Environmental conditions:

- Lay the device horizontally on a stable and solid surface in case the device may fall, causing serious damage.
- Make sure you leave plenty of space around the device for ventilation.
- Use this product in environments with ambient temperatures $-10^{\circ}\text{C} \sim 50^{\circ}\text{C}$.
- **DO NOT LEAVE THIS DEVICE IN AN ENVIRONMENT WHERE THE STORAGE TEMPERATURE MAY GO BELOW -20°C OR ABOVE 80°C .** This could damage the device. The device must be used in a controlled environment.

Care for your iBASE products:

- Before cleaning the device, turn it off and unplug all cables such as power in case a small amount of electrical current may still flow.
- Use neutral cleaning agents or diluted alcohol to clean the device chassis with a cloth. Then wipe the chassis with a dry cloth.
- Vacuum the dust with a computer vacuum cleaner to prevent the air vent or slots from being clogged.



WARNING

Attention during use:

- Do not use this product near water.
- Do not spill water or any other liquids on your device.
- Do not place heavy objects on the top of the device.
- Operate this device from the type of power indicated on the marking label. If you are not sure of the type of power available, consult your distributor or local power company.
- Do not walk on the power cord or allow anything to rest on it.
- If you use an extension cord, make sure that the total ampere rating of the product plugged into the extension cord does not exceed its limits.

Avoid Disassembly

You are not suggested to disassemble, repair or make any modification to the device. Disassembly, modification, or any attempt at repair could generate hazards and cause damage to the device, even bodily injury or property damage, and will void any warranty.



CAUTION

Replace only with the same or equivalent type recommended by the manufacturer. Dispose of used batteries according to the manufacturer's instructions.

Warranty Policy

- **IBASE standard products:**

24-month (2-year) warranty from the date of shipment. If the date of shipment cannot be ascertained, the product serial numbers can be used to determine the approximate shipping date.

- **3rd-party parts:**

12-month (1-year) warranty from delivery for the 3rd-party parts that are not manufactured by IBASE, such as CPU, memory, HDD, power adapter, panel and touchscreen.

* PRODUCTS, HOWEVER, THAT FAILS DUE TO MISUSE, ACCIDENT, IMPROPER INSTALLATION OR UNAUTHORIZED REPAIR SHALL BE TREATED AS OUT OF WARRANTY AND CUSTOMERS SHALL BE BILLED FOR REPAIR AND SHIPPING CHARGES.

Technical Support & Services

1. Visit the IBASE website at www.ibase.com.tw to find the latest information about the product.
2. If you need any further assistance from your distributor or sales representative, prepare the following information of your product and elaborate upon the problem.
 - Product model name
 - Product serial number
 - Detailed description of the problem
 - The error messages in text or in screenshots if there is any
 - The arrangement of the peripherals
 - Software in use (such as OS and application software, including the version numbers)
3. If repair service is required, you can download the RMA form at <http://www.ibase.com.tw/english/Supports/RMAService/>. Fill out the form and contact your distributor or sales representative.

Table of Contents

Chapter 1	General Information	1
1.1	Introduction.....	2
1.2	Features	2
1.3	Packing List	3
1.4	Optional Accessories.....	4
1.5	Specifications – AMI230	6
1.6	Specifications – AMI231	8
1.7	Specifications – AMI232	10
1.8	System View – AMI230	12
1.9	System View – AMI231	14
1.10	System View – AMI232	16
1.11	Dimensions – AMI230	18
1.12	Dimensions – AMI231	20
1.13	Dimensions – AMI232	21
Chapter 2	Hardware Configuration	23
2.1	Essential Installations	24
2.1.1	Memory Installation.....	25
2.1.2	SSD Installation	25
2.1.3	SIM Cards Installation.....	27
2.1.4	WiFi / 3G / 4G Antenna Installation	28
2.1.5	Wall Mount Installation	29
2.2	Setting the Jumpers.....	30
2.3	Jumper & Connector Locations on Motherboard	31
2.4	Jumpers Quick Reference	31
2.5	Connectors Quick Reference.....	36

Chapter 3	Driver Installation	45
3.1	Introduction	46
3.2	Intel® Chipset Software Installation Utility	46
3.3	Graphics Driver Installation	47
3.4	HD Audio Driver Installation	48
3.5	LAN Driver Installation	49
3.6	Intel® Management Engine Driver Installation	50
Chapter 4	BIOS Setup	51
4.1	Introduction	52
4.2	BIOS Setup	52
4.3	Main Settings	53
4.4	Advanced Settings	54
4.5	Chipset Settings	63
4.6	Security Settings	67
4.7	Boot Settings	69
4.8	Save & Exit Settings	70
Appendix		71
A.	I/O Port Address Map	72
B.	Interrupt Request Lines (IRQ)	74
C.	Watchdog Timer Configuration	75

Chapter 1

General Information

The information provided in this chapter includes:

- Features
- Packing List
- Optional Accessories
- Specifications
- Product View
- Dimensions

1.1 Introduction

The AMI230AF / AMI231AF / AMI232AF Series are designed for Intel® 9th/8th Gen. Core™/ Pentium® / Celeron® processors and suitable for thin clients, smart industrial automation or controller, and retail applications. Powered by 12V or 18V~24V DC wide-range voltage, it offers advanced features such as iSMART green technology with intelligent scheduler and power savings for better environmental performance, iAMT 11.6 for remote system monitoring, upgrading and repairing, as well as TPM for a high level of hardware-based security that prevent phishing attacks.



Photo of AMI230



1.2 Features

- Fanless system with IBASE MB230 customized board
- 8th Gen Intel® Core™ i7/i5/i3 Desktop Processors
- Dual SIM slots with WWAN redundancy
- 2x 2.5" HDD/SSD (with RAID 0/1 support)
- 4x Intel® Gigabit LAN with PoE, 3x M.2 (E-Key/ B-Key/ M-Key)
- Over/Under/Reverse voltage protection
- iSMART, iAMT (11.6), TPM (2.0)



1.3 Packing List

Your product package should include the items listed below. If any of the items below is missing, contact the distributor or the dealer from whom you purchased the product.



AMI230AF Series

- AMI230 x 1
- Power Cord x 1
- Terminal Block for DC-In Power Adaptor (5 pins) x 1
- Terminal Block for Remote Power Button (2 pins) x 1
- Wall Mount Kit x 1
- Flat Head Screw (for Wall Mount Kit) x 6
- 
 - Round Head Screw (for 2nd memory, if not pre-installed) x 2
- 
 - Disk (including drivers and this user manual) x 1

AMI231AF Series

- AMI231 x 1
- Power Cord x 1
- Terminal Block for DC-In Power Adaptor (5 pins) x 1
- Terminal Block for Remote Power Button (2 pins) x 1
- Wall Mount Kit x 1
- Flat Head Screw (for Wall Mount Kit) x 6
- 
 - Round Head Screw for 2nd memory (if not pre-installed) x 2
- 
 - Flat Head Screw for 2nd SSD (if not pre-installed) x 4
- 
 - Disk (including drivers and this user manual) x 1

AMI232AF Series

- AMI232 x 1
- Power Cord x 1
- Terminal Block for DC-In Power Adaptor (5 pins) x 1
- Terminal Block for Remote Power Button (2 pins) x 1
- Wall Mount Kit x 1
- Flat Head Screw (for Wall Mount Kit) x 6
- • Round Head Screw for 2nd memory (if not pre-installed) x 2
- • Flat Head Screw for 2nd SSD (if not pre-installed) x 4
- • Disk (including drivers and this user manual) x 1

1.4 Optional Accessories

iBASE provide optional accessories. Please contact us or your dealer if you need any of the following:

AMI230

- 270W(24V@11.25A) DC-In Power Adaptor kit
- WiFi or 4G/LTE Antenna Kit
- M.2 Thermal Kit (Storage for M.2)
- 4G Module PN: A024MDWIFI0040700P; M.2 LTE/GPS (Global) [SIERRA EM7565] for AMI230AF
- Wireless, M.2-2230 A E Key B2 PN: A008WIRELESS02200P; 802.11A/B/G/N/AC+BT[AW-CB260NF] RoHS2

AMI231

- 330W(24V@13.75A) DC-In Power Adaptor kit
- WiFi or 4G/LTE Antenna Kit
- Expansion Kit (with 2 cables for COM5 & COM6 ports): IP214, IP215
- M.2 Thermal Kit (Storage for M.2)
- 4G Module PN: A024MDWIFI0040700P; M.2 LTE/GPS (Global) [SIERRA EM7565] for AMI231AF
- Wireless, M.2-2230 A E Key B2 PN: A008WIRELESS02200P; 802.11A/B/G/N/AC+BT[AW-CB260NF] RoHS2

AMI232

- 330W(24V@13.75A) DC-In Power Adaptor kit
- WiFi or 4G/LTE Antenna Kit
- M.2 Thermal Kit (Storage for M.2)
- Expansion Kit (with 2 cables for COM5 & COM6 ports): IP211, IP212
- Expansion Card: IP213
- 4G Module PN: A024MDWIFI0040700P; M.2 LTE/GPS (Global) [SIERRA EM7565] for AMI232AF
- Wireless; M.2-2230 A E Key B2 PN: A008WIRELESS02200P; 802.11A/B/G/N/AC+BT[AW-CB260NF] RoHS2

Name	Features
IP211	1 x PCIe (x1), 1 x PCIe (x8), 2 x COM (COM5 & COM6), 1 x SATA II, 2 x USB 2.0
IP212	1 x PCIe (x16), 2 x COM (COM5 & COM6), 1 x SATA II, 2 x USB 2.0
IP213	1 x PCI, 1 x PCIe (x16), 1 x SATA III, 2 x USB 2.0
IP214	1 x PCIe (x16), 2 x COM (COM5 & COM6), 2 x USB 2.0
IP215	1 x PCI, 2 x COM (COM5 & COM6), 2 x USB 2.0

1.5 Specifications – AMI230

Product Name	AMI230AF *Dual SIM slots support SIERRA module* AMI230AF-P *(supports PCIe function for M.2 (B-Key) single SIM slot does not support SIERRA module *	
System		
Motherboard	MB230AF MB230AF-P* (supports PCIe function for M.2 (B-Key) single SIM slot does not support SIERRA module *	
Operating System	<ul style="list-style-type: none"> • Windows 10 (64-bit) • Linux Ubuntu / Fedora 24 	
CPU	Intel® 9th/8th Gen. Core™ / Pentium® / Celeron® processors TDP = 35W	
Chipset	Intel® Q370	
Memory	1 x DDR4-2666/2400 SO-DIMM 8GB, expandable to 32 GB (Non-ECC)	
Super I/O	Fintek F81966AD-I	
Audio Codec	Realtek ALC888S-VD2-GR	
Network	<ul style="list-style-type: none"> • Intel® I219LM GbE PHY, Intel® I210IT GbE, Intel® I210IT GbE, Intel® I210IT GbE 	
SATA	<ul style="list-style-type: none"> • 1x SATAIII port for 2.5" SATA HDD or SSD 	
M.2	<ul style="list-style-type: none"> • 1x M.2(B-key@3042) • 1x M.2(E-key@2230) • 1x M.2(M-key@2280) 	
Front Panel I/O	<ul style="list-style-type: none"> • 2x RS232/422/485 port for COM#1~2 • 2x RS232 port for COM#3~4 • 1x DisplayPort(1.2) for video output • 2x RJ45 port (supports 802.3at,PoE+) • DC-in terminal block for 12V or 18V~24V voltage input • 2 x Antenna hole for WiFi/BT and 4G/LTE module 	
Rear Panel I/O	<ul style="list-style-type: none"> • 1x DVI-D + HDMI (1.4) • 8x USB3.1 ports • 2x RJ45 • 2x Antenna hole for WiFi/BT and 4G/LTE module 	
Front Panel I/O	<ul style="list-style-type: none"> • 1x DVI-D + HDMI (1.4) • 8x USB3.1 ports • 2x RJ45 • 2x Antenna hole for WiFi/BT and 4G/LTE module 	<ul style="list-style-type: none"> • 1x red HDD LED + 2 blue PoE+ LED • 1x power button (green LED) • 1x 2-pin terminal block for external power button • Dual SIM card slots
BIOS	AMI BIOS	
Other Features	iSMART 3.8, TPM 2.0, iAMT 11.6	

Mechanical and Environmental	
Dimensions	210mm(W) x 285mm(D) x 77mm(H)
Construction	Aluminum
Chassis color	Silver + Gray
Mounting type	Desktop & Wall mount
Operating Temperature	-20°C to 70°C (-4°F~158°F) (for 35W CPU)
Storage Temperature	-20°C~80°C (-4°F~176°F)
Humidity	5%~90%@45°C (non-condensing)
Vibration	Operating: 3Grms / 5~500Hz
Shock	Operating: 20G / 11ms Non-operating: 40G / 11ms
Certification	CE FCC Class A / LVD IP40

All specifications are subject to change without prior notice.

1.6 Specifications – AMI231

Product Name	AMI231AF *Dual SIM slots support SIERRA module* (1x expansion slot version) AMI231AF-P *(supports PCIe function for M.2 (B-KEY) single SIM slot does not support SIERRA module * (1x expansion slot version)	
System		
Motherboard	MB230AF MB230AF-P* (supports PCIe function for M.2 (B-KEY) single SIM slot does not support SIERRA module *	
Operating System	<ul style="list-style-type: none"> • Windows 10 (64-bit) • Linux Ubuntu / Fedora 24 	
CPU	Intel® 9th/8th Gen. Core™ / Pentium® / Celeron® processors TDP = 35W	
Chipset	Intel® Q370	
Memory	1 x DDR4-2666/2400 SO-DIMM 8GB, expandable to 32 GB (Non-ECC)	
Super I/O	Fintek F81966AD-I	
Audio Codec	Realtek ALC888S-VD2-GR	
Network	<ul style="list-style-type: none"> • Intel® I219LM GbE PHY, Intel® I210IT GbE, Intel® I210IT GbE, Intel® I210IT GbE 	
SATA	<ul style="list-style-type: none"> • 2x SATAIII port for 2.5" SATA HDD or SSD 	
M.2	<ul style="list-style-type: none"> • 1x M.2(B-Key@3042) • 1x M.2(E-Key@2230) • 1x M.2(M-Key@2280) 	
Expansion Slot	<ul style="list-style-type: none"> • 1x PCI-E (x16) • 1x PCI-E (x4) 	
Rear Panel I/O	<ul style="list-style-type: none"> • 2x RS232/422/485 port for COM#1~2 • 2x RS232 port for COM#3~4 • 1x DisplayPort(1.2) for video output • 2x RJ45 port (supports 802.3at,PoE+) • DC-in terminal block for 12V or 18V~24V voltage input • 2 x Antenna hole for WiFi/BT and 4G/LTE module • 2 x DB9M connectors for COM#5 + COM#6 ports (by IP214/215) 	
Front Panel I/O	<ul style="list-style-type: none"> • 1x DVI-D + HDMI (1.4) • 8x USB3.1 ports • 2x RJ45 • 2x Antenna hole for WiFi/BT and 4G/LTE module 	<ul style="list-style-type: none"> • 1x red HDD LED + 2 blue PoE+ LED • 1x power button (green LED) • 1x 2-pin terminal block for external power button • Dual SIM card slots
BIOS	AMI BIOS	
Watchdog	Watchdog Timer 256 segments, 0, 1, 2...255 sec/min	
Others	iSMART 3.8, TPM 2.0, iAMT 11.6	

Mechanical and Environmental	
Dimensions	210mm(W) x 285mm(D) x 109mm(H)
Construction	Aluminum
Chassis color	Silver + Gray
Mounting type	Desktop & Wall mount
Operating Temperature	-20°C to 70°C (-4°F~158°F) (for 35W CPU)
Storage Temperature	-20°C~80°C (-4°F~176°F)
Humidity	5%~90%@45°C (non-condensing)
Vibration	Operating: 3Grms / 5~500Hz
Shock	Operating: 20G / 11ms Non-operating: 40G / 11ms
Certification	CE FCC Class A / LVD IP40

All specifications are subject to change without prior notice.

1.7 Specifications – AMI232

Product Name	AMI232AF *Dual SIM Slot support SIERRA module* (2x expansion slot version) AMI232AF-P*(supports PCIe function for M.2 (B-KEY) single SIM Slots do NOT support SIERRA module * (2x expansion slot version)	
System		
Motherboard	MB230AF MB230AF-P*(supports PCIe function for M.2 (B-KEY) single SIM slot does not support SIERRA module *	
Operating System	<ul style="list-style-type: none"> • Windows 10 (64-bit) • Linux Ubuntu / Fedora 24 	
CPU	Intel® 9th/8th Gen. Core™ / Pentium® / Celeron® processors TDP = 35W	
Chipset	Intel® Q370	
Memory	1 x DDR4-2666/2400 SO-DIMM 8GB, expandable to 32 GB (Non-ECC)	
Super I/O	Fintek F81966AD-I	
Audio Codec	Realtek ALC888S-VD2-GR	
Network	<ul style="list-style-type: none"> • Intel® I219LM GbE PHY, Intel® I210IT GbE, Intel® I210IT GbE, Intel® I210IT GbE, 	
SATA	<ul style="list-style-type: none"> • 2x SATAIII port for 2.5" SATA HDD or SSD 	
M.2	<ul style="list-style-type: none"> • 1x M.2(B-Key@3042) • 1x M.2(E-Key@2230) • 1x M.2(M-Key@2280) 	
Expansion Slot	<ul style="list-style-type: none"> • 1x PCI-E (x16) • 1x PCI-E (x4) 	
Rear Panel I/O	<ul style="list-style-type: none"> • 2x RS232/422/485 port for COM#1~2 • 2x RS232 port for COM#3~4 • 1x DisplayPort(1.2) for video output • 2x RJ45 port (supports 802.3at,PoE+) • DC-in terminal block for 12V or 18V~24V voltage input • 2 x Antenna hole for WiFi/BT and 4G/LTE module • 2 x DB9M connectors for COM#5 + COM#6 ports (by IP211/212) 	
Front Panel I/O	<ul style="list-style-type: none"> • 1x DVI-D + HDMI (1.4) • 8x USB3.1 ports • 2x RJ45 • 2x Antenna hole for WiFi/BT and 4G/LTE module 	<ul style="list-style-type: none"> • 1x red HDD LED + 2 blue PoE+ LED • 1x power button (green LED) • 1x 2-pin terminal block for external power button • Dual SIM card slots
BIOS	AMI BIOS	
Watchdog	Watchdog Timer 256 segments, 0, 1, 2...255 sec/min	
Others	iSMART 3.8, TPM 2.0, iAMT 11.6	

Mechanical and Environmental	
Dimensions	210mm(W) x 285mm(D) x 129mm(H)
Construction	Aluminum
Chassis color	Silver + Gray
Mounting type	Desktop & Wall mount
Operating Temperature	-20°C to 70°C (-4°F~158°F) (for 35W CPU)
Storage Temperature	-20°C~80°C (-4°F~176°F)
Humidity	5%~90%@45°C (non-condensing)
Vibration	Operating: 3Grms / 5~500Hz
Shock	Operating: 20G / 11ms Non-operating: 40G / 11ms
Certification	CE FCC Class A / LVD IP40

All specifications are subject to change without prior notice.

1.8 System View – AMI230

Front View

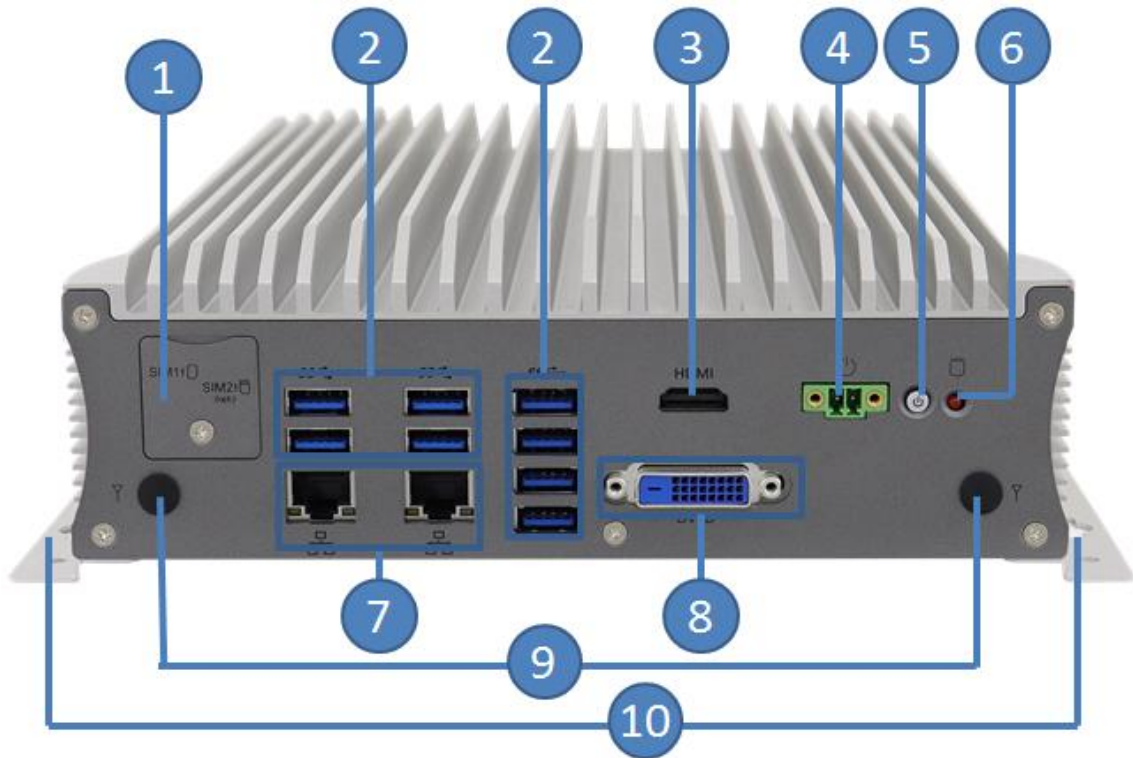

No.	Name	No.	Name
1	SIM Card Slots	6	LED Indicator for HDD
2	USB Ports	7	RJ45
3	HDMI	8	DVI-D Port
4	Terminal Block for external Power Button	9	Antenna holes
5	Power Button	10	Mounting Brackets

Rear View

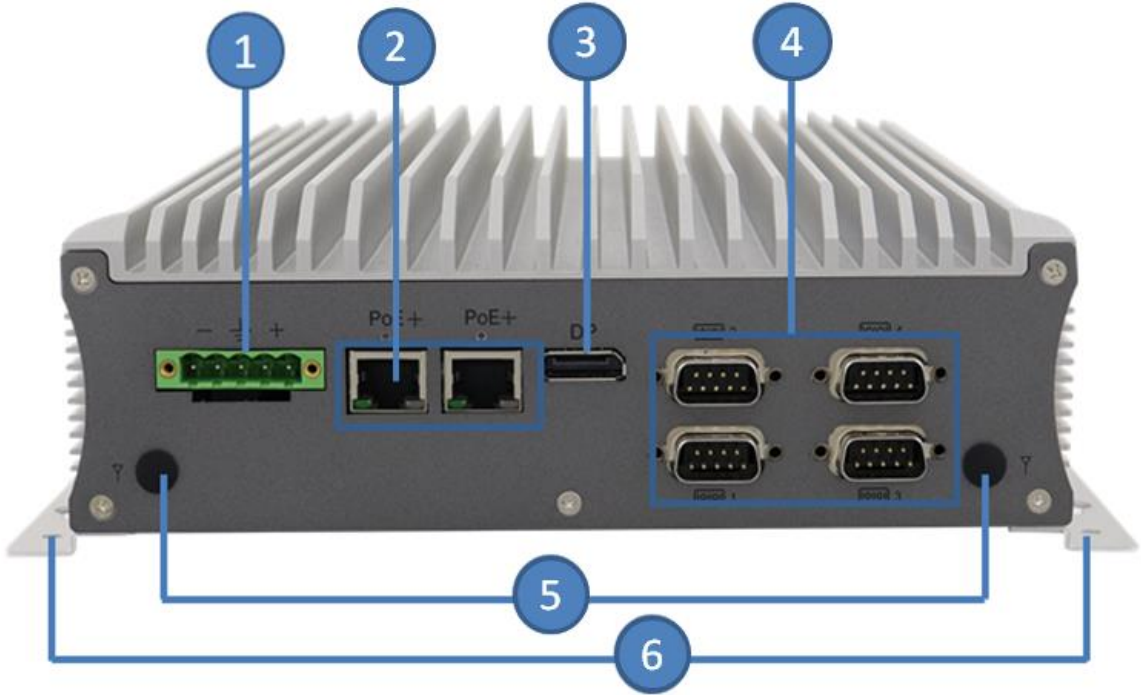

No.	Name	No.	Name
1	DC-In Power Connector for 12V or 18V~24V input	4	4x COM Ports
2	2x RJ45 port (supports 802.3at,PoE+)	5	Antenna hole for Wifi/BT and 4G/LTE module
2	DisplayPort	6	Wall Mount Brackets

Oblique View



1.9 System View – AMI231

Front View

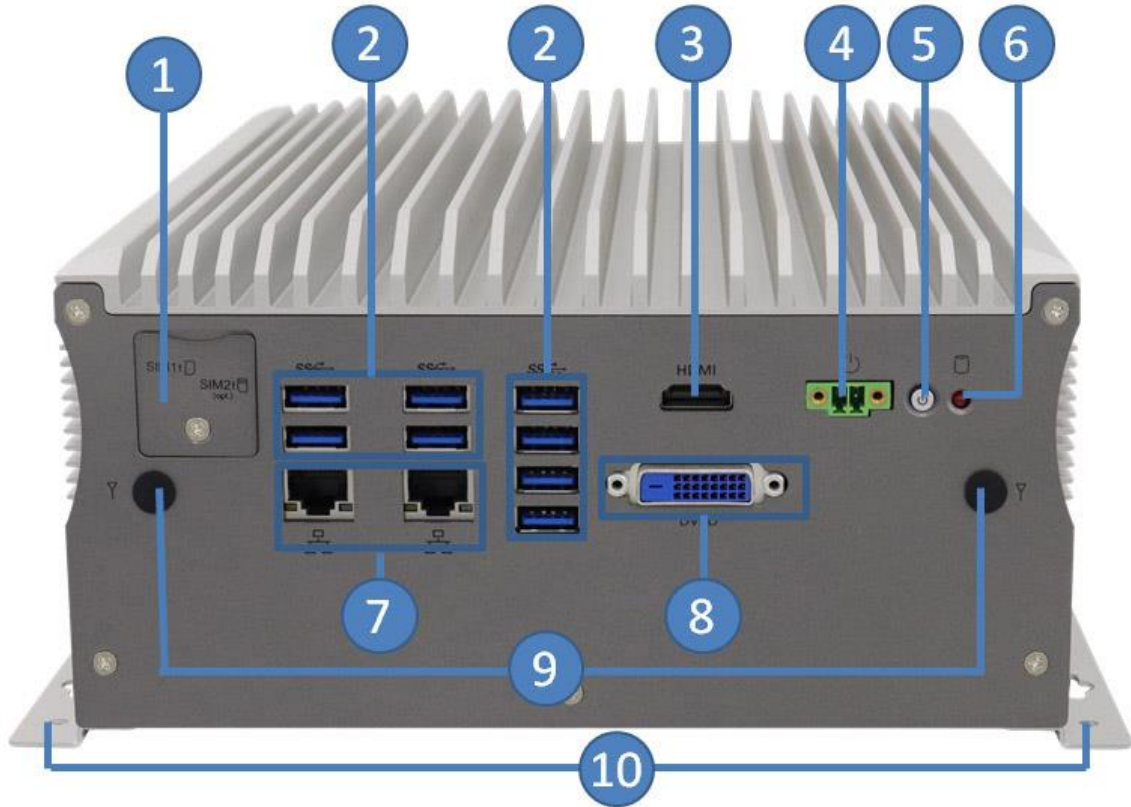

No.	Name	No.	Name
1	SIM Card Slots	6	LED Indicator for HDD
2	USB Ports	7	RJ45
3	HDMI	8	DVI-D Port
4	Terminal Block for external Power Button	9	Antenna holes
5	Power Button	10	Mounting Brackets

Rear View

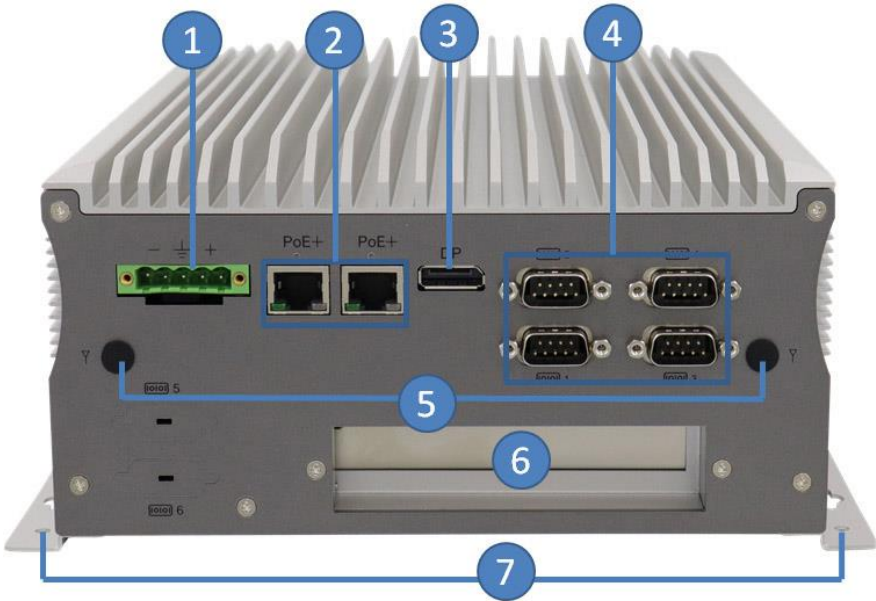

No.	Name	No.	Name
1	DC-In Power Connector for 12V or 18V~24V input	5	Antenna hole for Wifi/BT and 4G/LTE module
2	2x RJ45 port (supports 802.3at,PoE+)	6	Expansion Slot
3	DisplayPort	7	Wall Mount Brackets
4	4x COM Ports		

Compatible Expansion Cards:

Name	Features
IP214	1 x PCIe (x16), 2 x COM (COM5 & COM6), 2 x USB 2.0
IP215	1 x PCI, 2 x COM (COM5 & COM6), 2 x USB 2.0

Oblique View



1.10 System View – AMI232

Front View

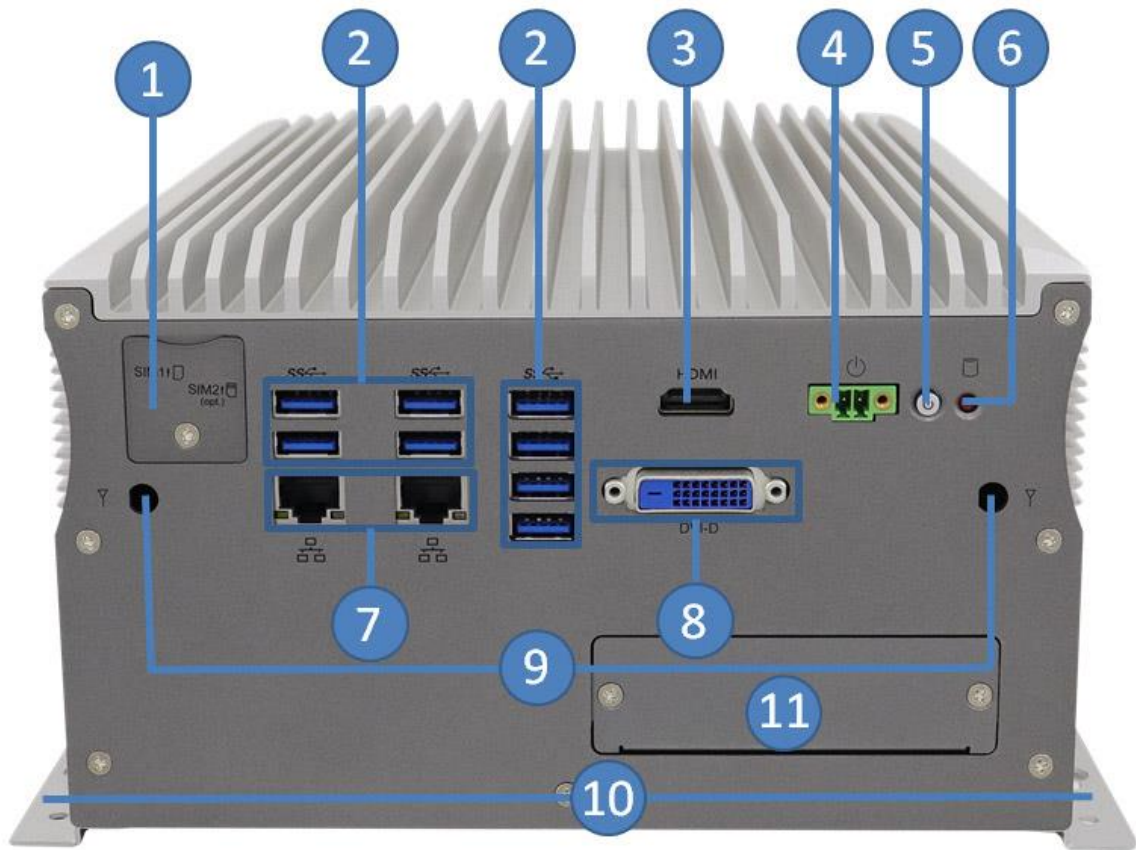

No.	Name	No.	Name
1	SIM Card Slots	7	RJ45
2	USB Ports	8	DVI-D Port
3	HDMI	9	Antenna holes
4	Terminal Block for external Power Button	10	Mounting Brackets
5	Power Button	11	Door for Fieldbus Module
6	LED Indicator for HDD		

Rear View

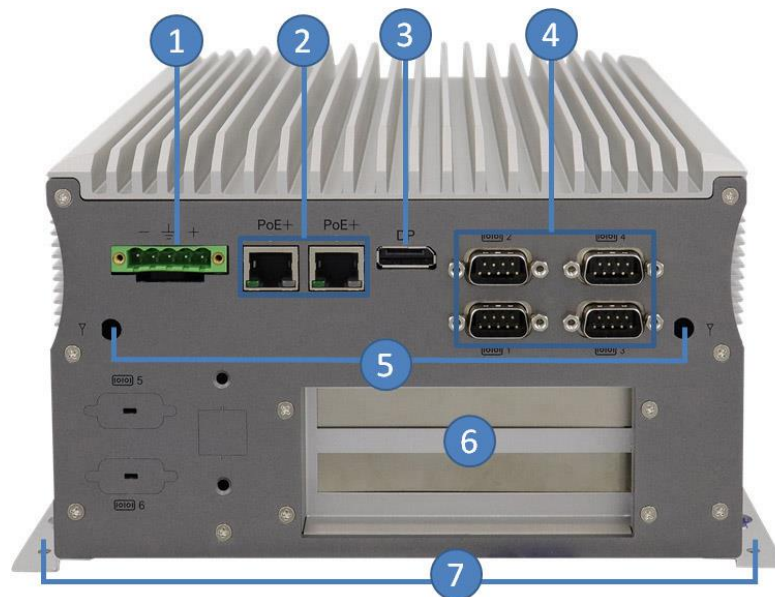

No.	Name	No.	Name
1	DC-In Power Connector for 12V or 18V~24V input	5	Antenna hole for Wifi/BT and 4G/LTE module
2	2x RJ45 port (supports 802.3at, PoE+)	6	Expansion Slots
3	DisplayPort	7	Wall Mount Brackets
4	4x COM Ports		

Compatible Expansion Cards:

Name	Features
IP211	1 x PCIe (x1), 1 x PCIe (x8), 2 x COM (COM5 & COM6), 1 x SATA II, 2 x USB 2.0
IP212	1 x PCIe (x16), 2 x COM (COM5 & COM6), 1 x SATA II, 2 x USB 2.0
IP213	1 x PCI, 1 x PCIe (x16), 1 x SATA III, 2 x USB 2.0

Oblique View



1.11 Dimensions – AMI230

Unit: mm

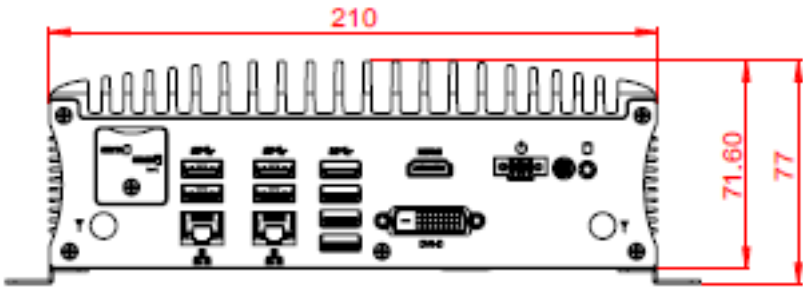
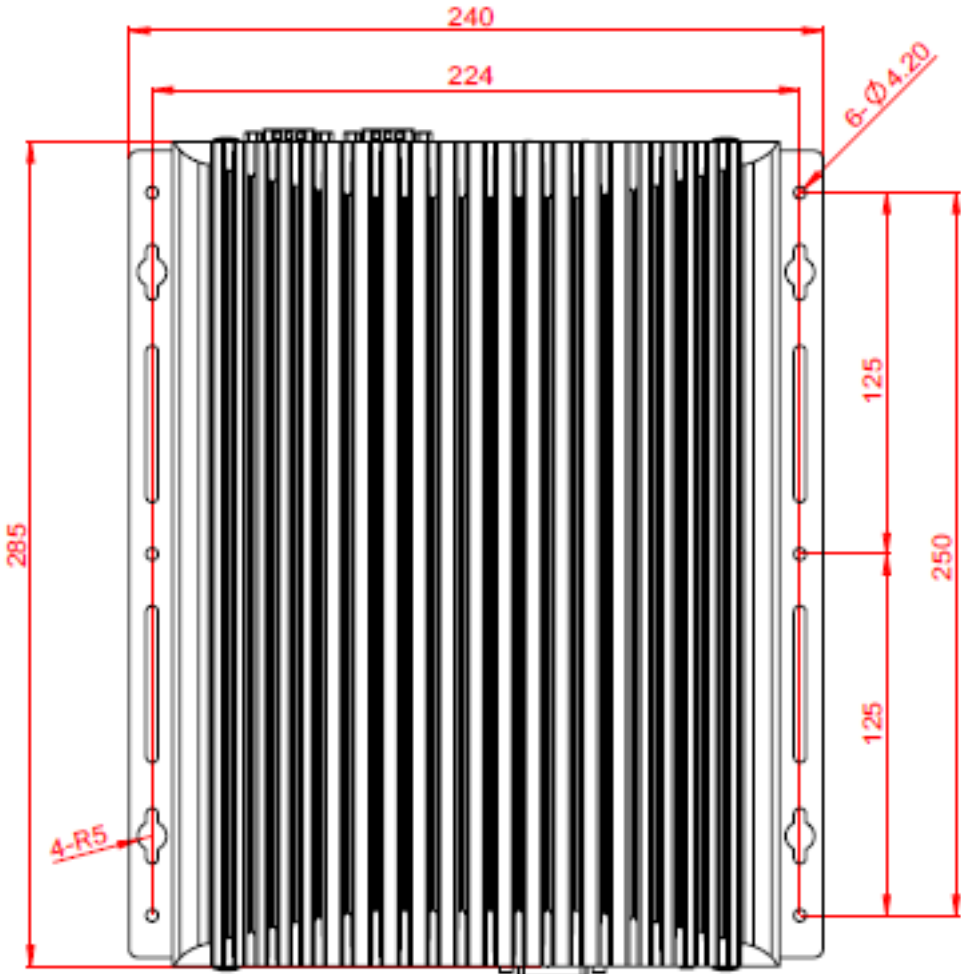

1.12 Dimensions – AMI231

Unit: mm

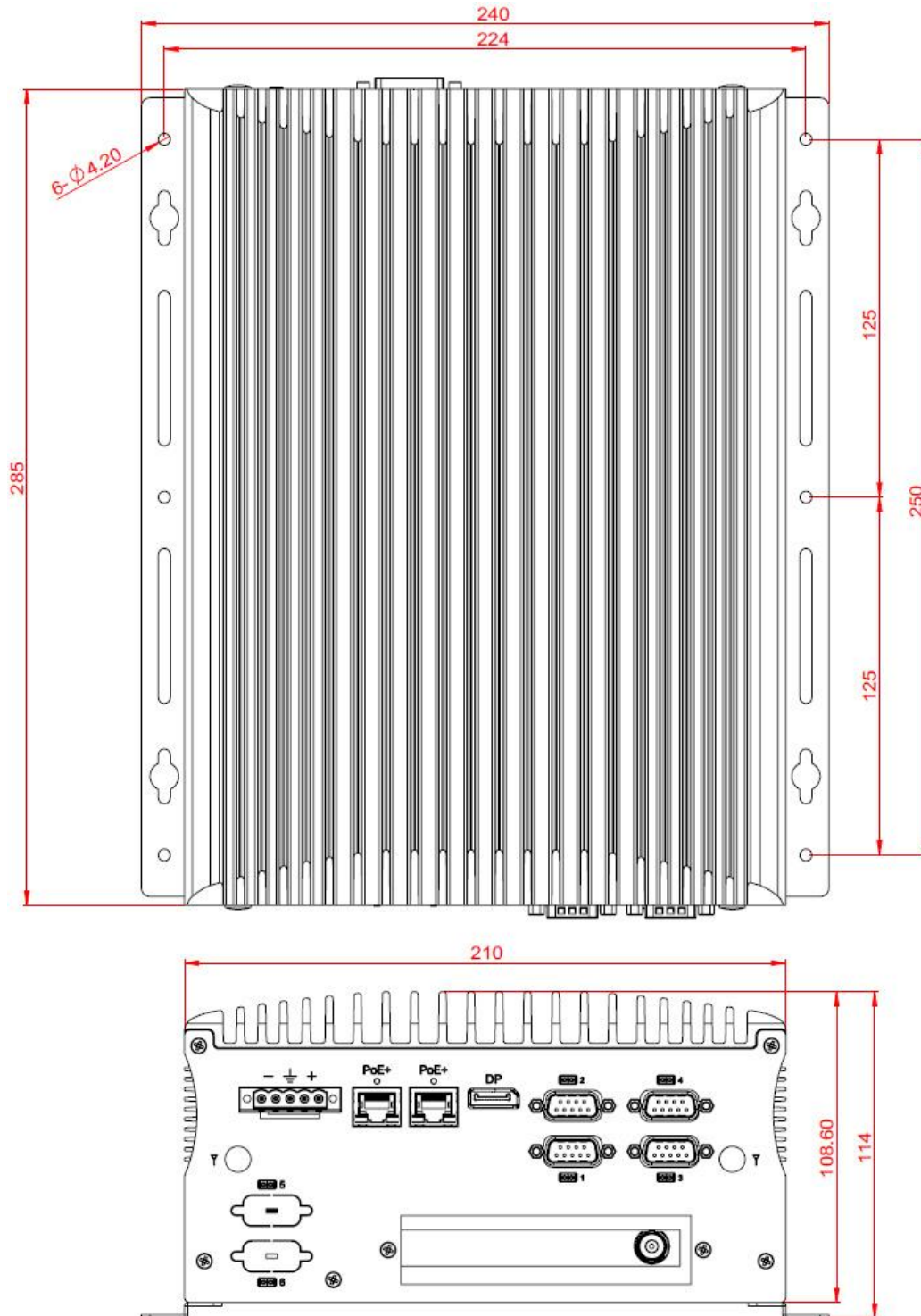

1.13 Dimensions – AMI232

Unit: mm

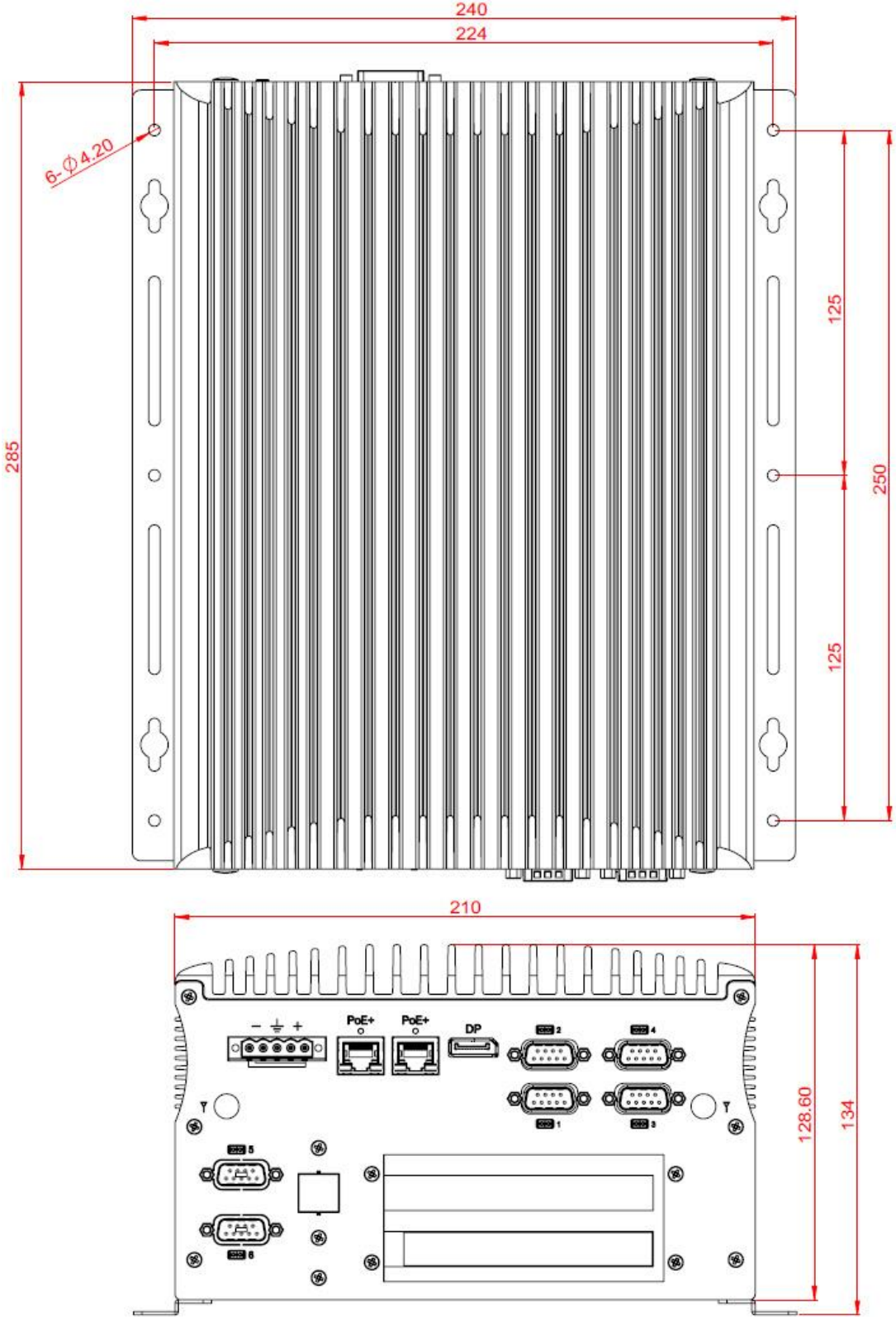

This page is intentionally left blank.

Chapter 2

Hardware Configuration

The information provided in this chapter includes:

- Essential installations before you begin
- Information and locations of connectors

2.1 Essential Installations

Remove the system bottom cover for all installations except in the installations of SIM cards and the outer SSD. Secure the cover after every installation.

AMI230

Release the 10 screws to remove the device bottom cover.

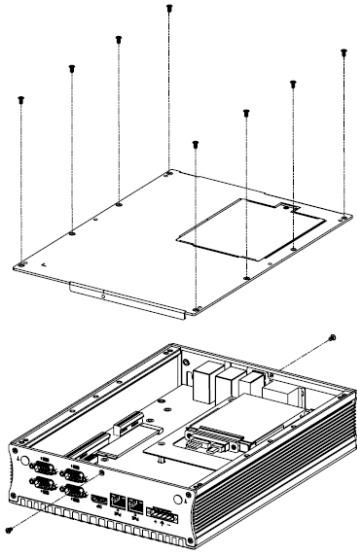

AMI231 / AMI232

This is illustrations are for AMI231.

Release 12 screws to disassemble the device bottom cover.

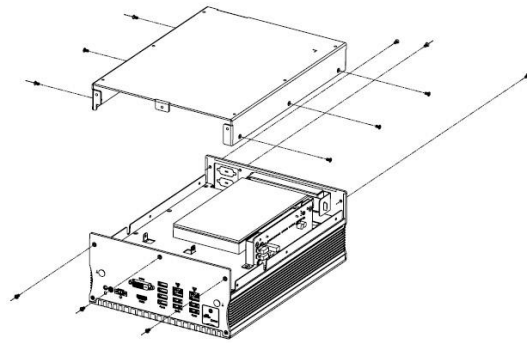

For slots inside the AMI231 & AMI232, you also need to disassemble the intermediate plate by removing the front I/O cover first and then removing 8 screws as shown below.

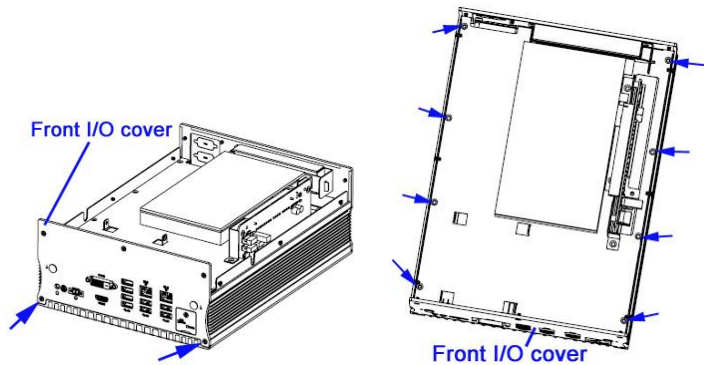

After installation, secure the intermediate plate and the device bottom cover back.

2.1.1 Memory Installation

Perform the following steps to replace or install the memory modules.

1. Locate the memory slot and align the key of the memory module with that on the memory slot.

Insert the module slantwise and gently push the module straight down until the clips of the slot close to hold the module in place when the module touches the bottom of the slot. Press the clips outwards with both hands to remove the module.

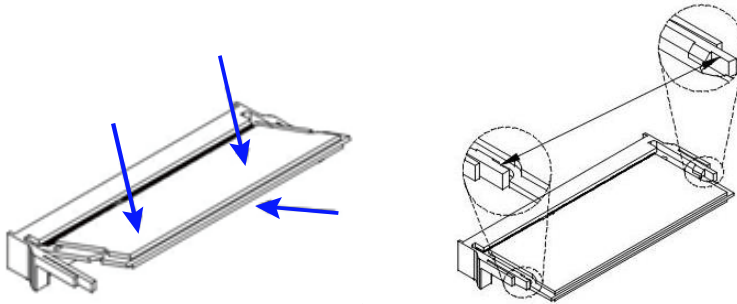

2.1.2 SSD Installation

Perform the following steps to replace or install the SSD.

AMI230

1. With the system upside down, loosen the SSD compartment screw.
2. Pull the door and install the SSD onto the bay, and connect related cables.
3. Replace the SSD kit into position and tighten the screw.

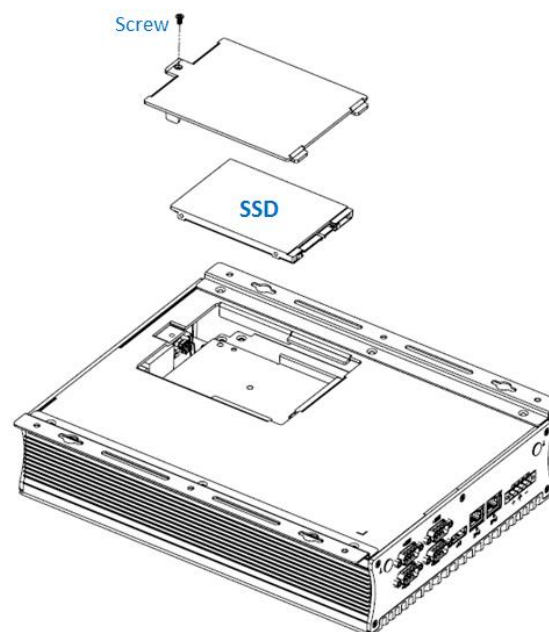

AMI231 / AMI232

For the 1st (default) SSD:

(This is illustrated by the example of AMI231.)

1. Loosen 4 screws, take out the original 2.5" SSD and attach a new one after you disassemble the device bottom cover.
2. Secure the SSD with the 4 screws mentioned above.

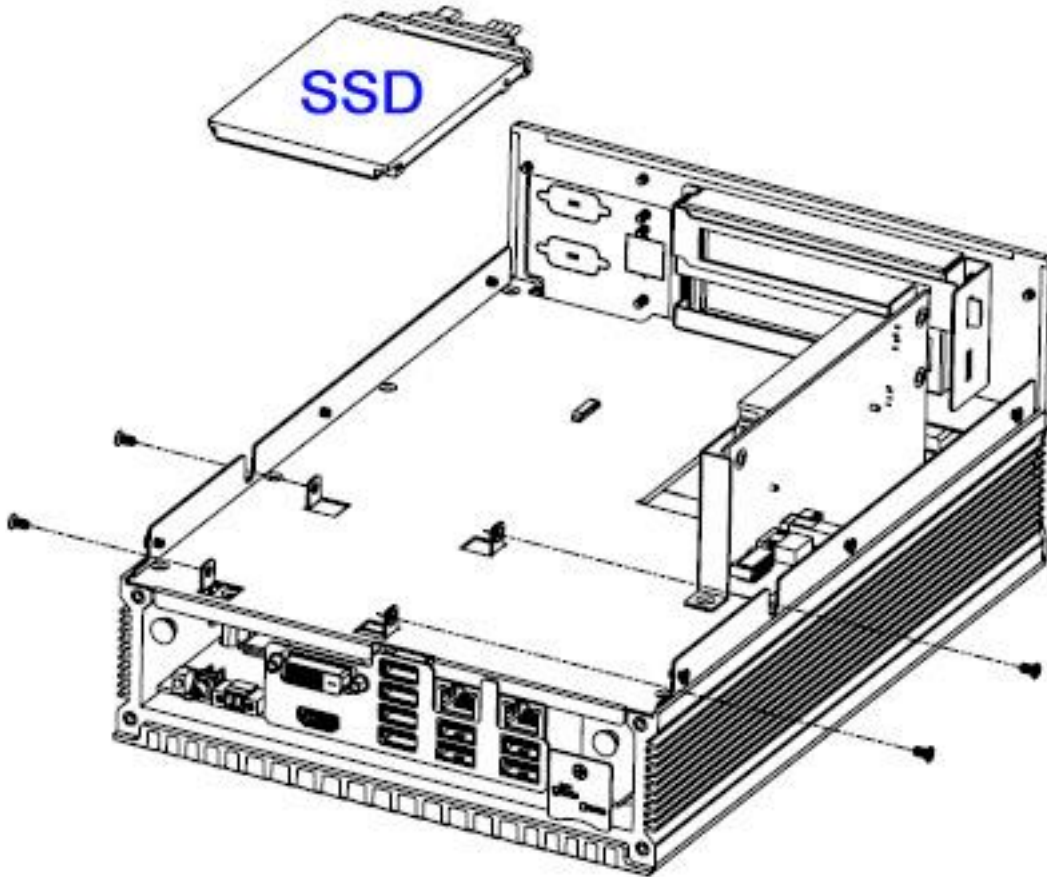

2.1.3 SIM Cards Installation

Release the single screw to open the SIM card slot door. Insert the SIM into one of the slots and push the card again if you want to remove it. Replace the screw to return the SIM card slot door in place

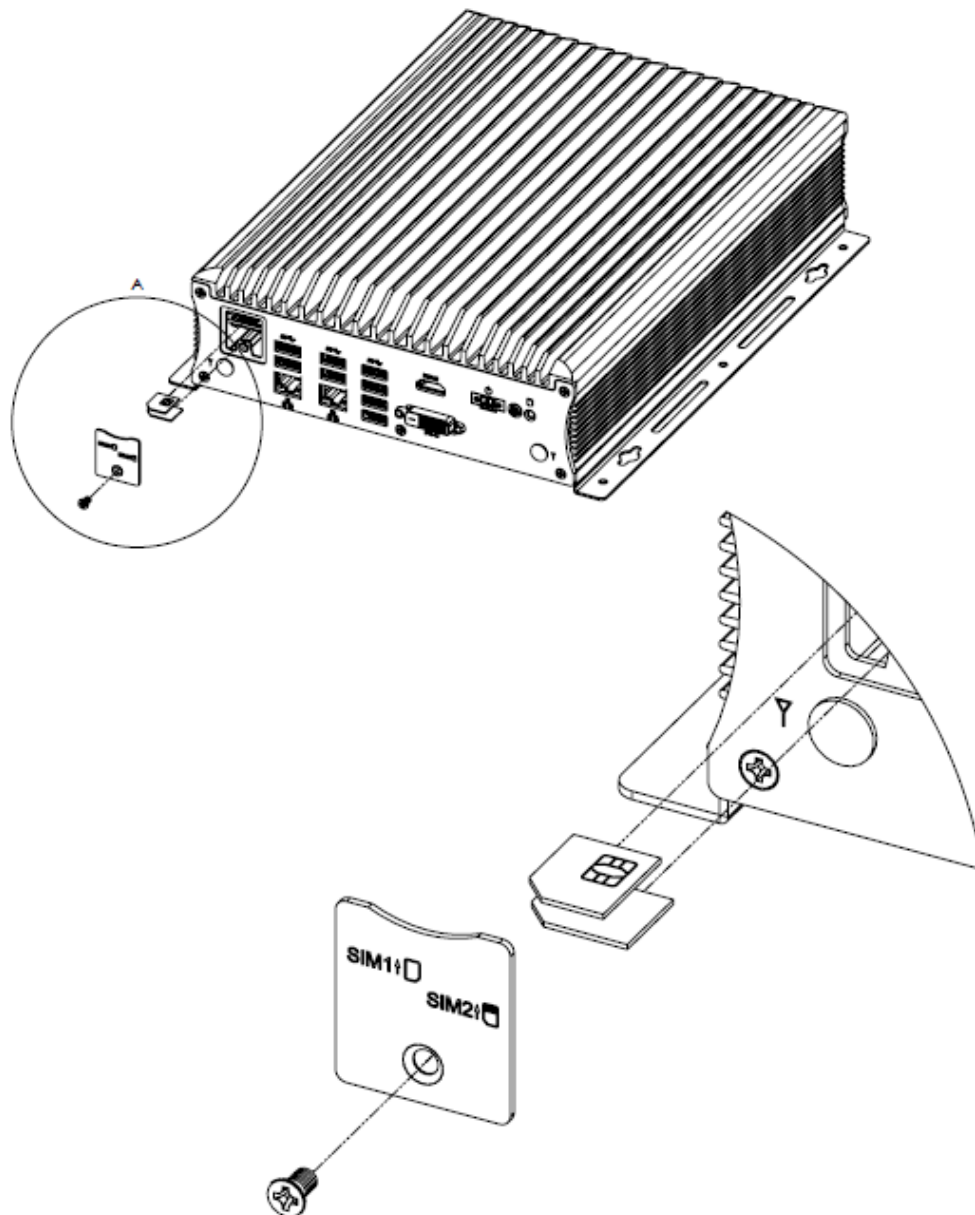

2.1.4 WiFi / 3G / 4G Antenna Installation

Thread the WiFi / 3G / 4G antenna extension cable through an antenna hole of the front I/O cover and fasten the antenna as shown below. Then apply adhesive to the edge of the hex nut behind the front I/O cover to prevent the extension cable from falling if the cable becomes loose.

1. Thread and fasten the hex nut and the washer. Then install the antenna.

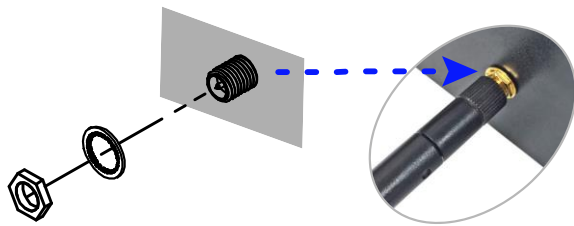

2. Apply adhesive around here.

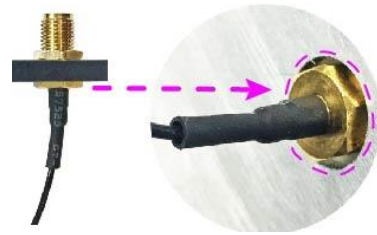

Info: The diameter of the nut is around 6.35 mm (0.25"-36UNC).

2.1.5 Wall Mount Installation

When mounting the system on a wall, ensure that you have enough room for power and signal cable routing, and have good ventilation. The method of mounting must be able to support weight of the system plus the suspended weight of all the cables attached to the system.

Wall mount installation instructions:

This is illustrated below using AMI230.

1. Attach the mounting brackets to the system and secure them with the supplied 6 screws.

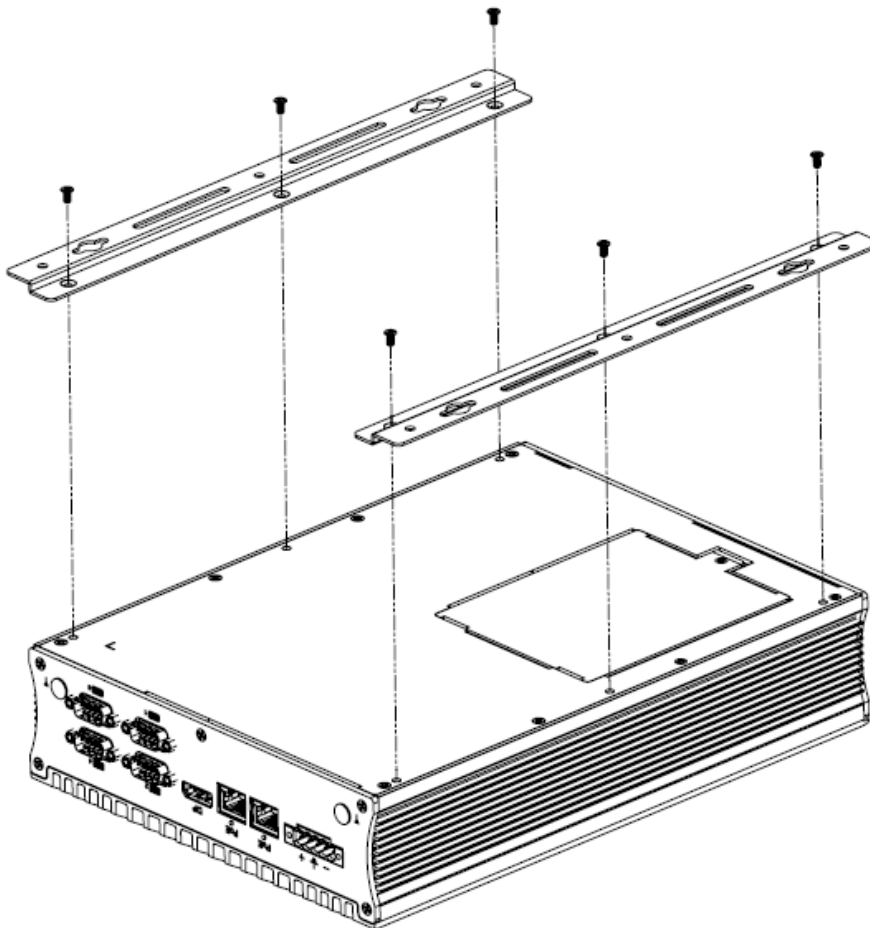

2. Prepare at least 4 screws (M3) to mount the system to the desired wall or location.

2.2 Setting the Jumpers

Set up and configure your device by using jumpers for various settings and features according to your needs and applications. Contact your supplier if you have doubts about the best configuration for your use.

2.2.1 How to Set Jumpers

Jumpers are short-length conductors consisting of several metal pins with a non-conductive base mounted on the circuit board. Jumper caps are used to have the functions and features enabled or disabled. If a jumper has 3 pins, you can connect either PIN1 to PIN2 or PIN2 to PIN3 by shorting.

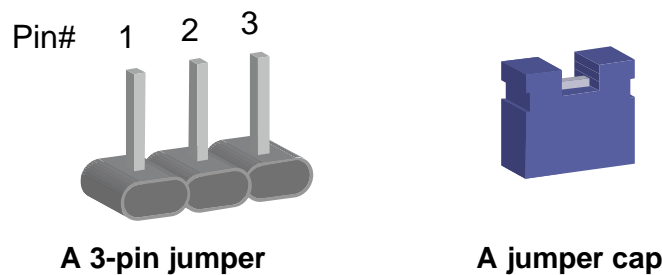

Refer to the illustration below to set jumpers.

Pin closed	Oblique view	Schematic illustration in the manual
Open		
1-2		
2-3		

When two pins of a jumper are encased in a jumper cap, this jumper is **closed**, i.e. turned **On**.

When a jumper cap is removed from two jumper pins, this jumper is **open**, i.e. turned **Off**.

2.3 Jumper & Connector Locations on Motherboard

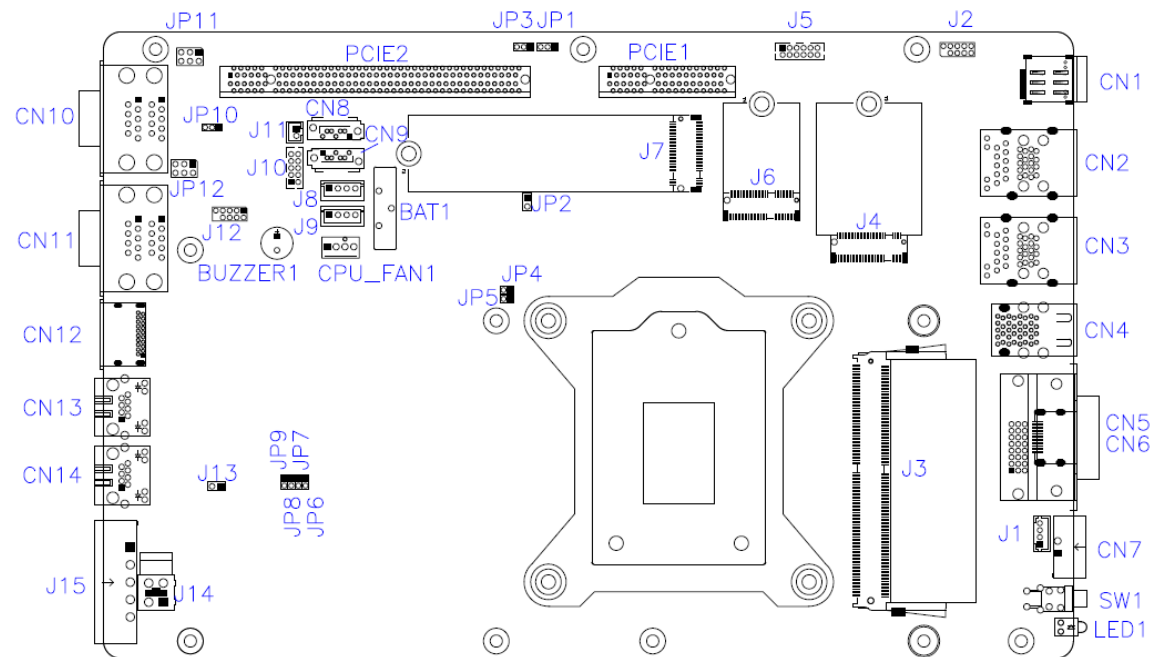

MB230 Motherboard

2.4 Jumpers Quick Reference

Function	Jumper Name	Page
Clearing CMOS Data	JP1	17
Clearing ME Register	JP3	17
PCIe Bifurcation Selection	JP4, JP5	18
Factory Use Only	JP2, JP6, JP7, JP8, JP9, J12	
ATX/AT Select	JP10	18
RI Power Select	JP11, JP12	19
PCI Express Reversal Selection	JP13	20

JP1: Clearing CMOS Data

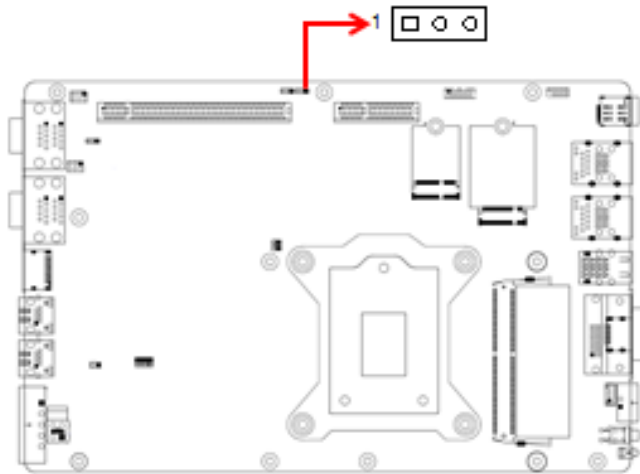

Function	Pin closed	Illustration
Normal (default)	1-2	1
Clear CMOS	2-3	1



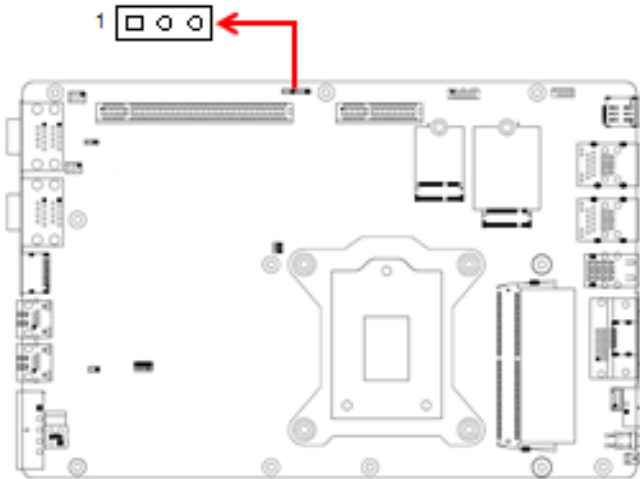



JP3: Clearing ME Register

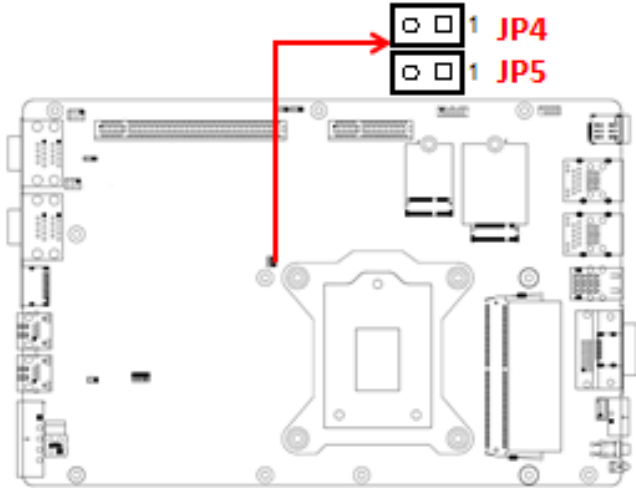

Function	Pin closed	Illustration
Normal (default)	1-2	1
Clear ME	2-3	1

JP4 & JP5: PCIe (x16) Bifurcation Selection



Function	Pin closed	Illustration
1 x PCIe (x16) (default)	JP5: Open	 1
	JP4: Open	 1
2 x PCIe (x8)	JP5: Open	 1
	JP4: Close	 1
1 x PCIe (x8) 2 x PCIe (x4)	JP5: Close	 1
	JP4: Close	 1

JP10: ATX/AT Select

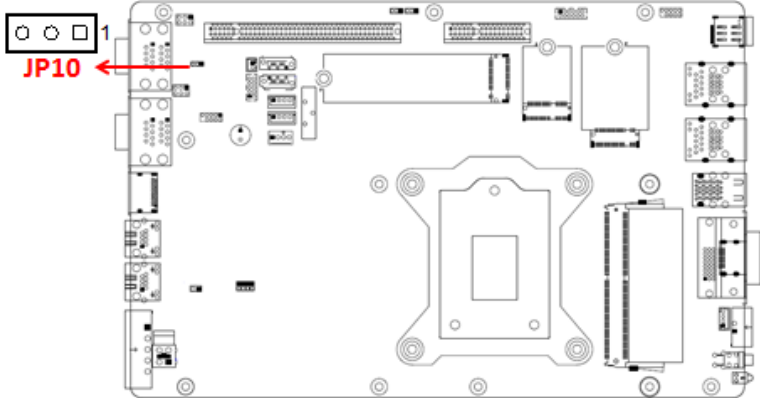

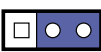
Function	Pin closed	Illustration
ATX (default)	1-2	1 
AT Mode	2-3	1 

JP11, JP12: COM4 & COM3 RS-232 Power Selection (JP11, JP12)

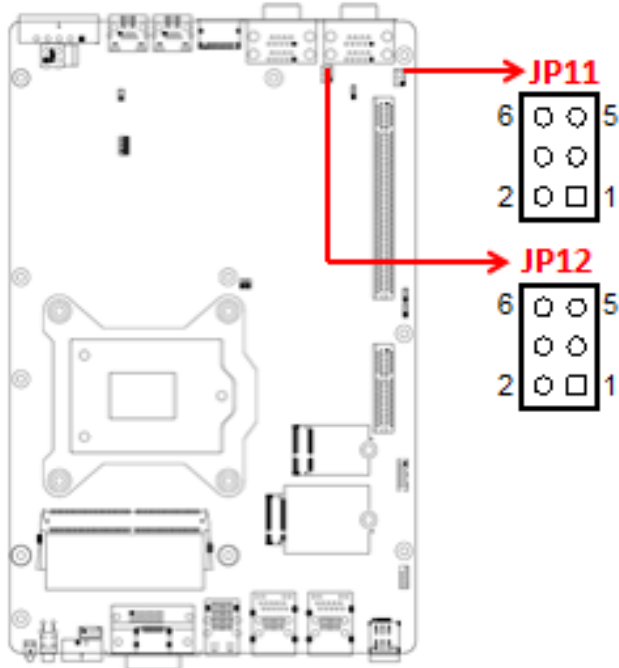

Function	Pin closed	Illustration
12V	1-3	
RI (default)	3-4	
5V	3-5	

JP13: PCI Express Reversal Selection

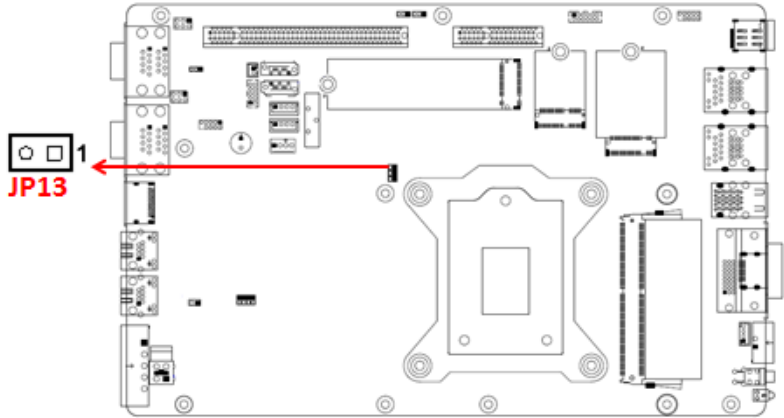

Function	Pin	Illustration
1x PCIe(x16) Reversed	Open (Normal)	1
	Close (Reversed)	1

2.5 Connectors Quick Reference

Function	Connector Name	Page
COM1 & COM2 Ports	CN11	21
COM3 & COM4 RS-232 Ports	CN10	22
Digital I/O Connector	J10	22
CPU Fan Connector	CPU_FAN1	23
PCIe (x16) Slot	PCIE2	23
PCIe (x4) Slot	PCIE1	23
DC_IN Power 2X2 Connector	J14	24
DC_IN Connector DINKLE	J15	24
ISMART Debug Connector (factory use)	J1	24-
SPI Flash Connector (factory use)	J2	24
LPC Debug Connector (factory use)	J12	25
SATA Power Connector	J8,J9	25
Reset Button Connector	J11	26
Power Button	SW1/ CN7	26
GbE LAN Port & Dual USB 3.1 Gen1 Ports	CN2, CN3	26
PSE LAN (I210IT)	CN13,CN14	27
Audio Connector	J5	27
SATA III Port	CN8, CN9	--
DDR4 SO-DIMM Slot	J3, J16	--
M.2 M2280 Slot	J7	--
M.2 E2230 Slot	J6	--
M.2 B3042 Slot	J4	--

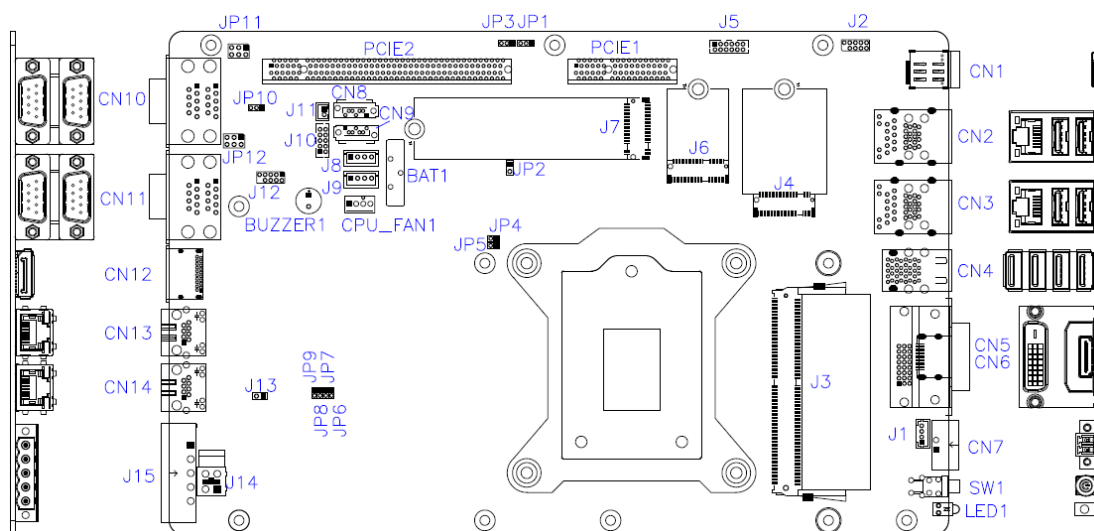

MB230 Motherboard

CN11: COM1 & COM2 RS-232/422/485 Ports

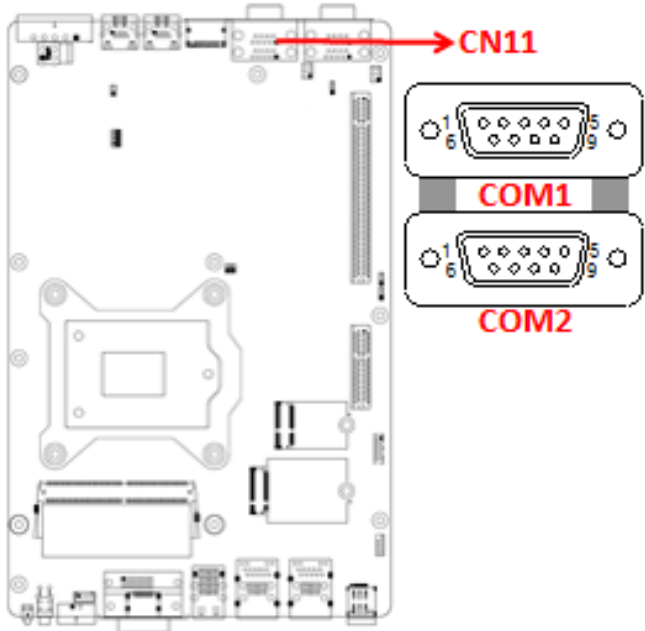

Pin	Signal Name	Pin	Signal Name
1	DCD, Data carrier detect	6	DSR, Data set ready
2	RXD, Receive data	7	RTS, Request to send
3	TXD, Transmit data	8	CTS, Clear to send
4	DTR, Data terminal ready	9	RI, Ring indicator
5	Ground		

Pin	Signal Name		
	RS-232	RS-422	RS-485
1	DCD	TX-	DATA-
2	RX	TX+	DATA+
3	TX	RX+	NC
4	DTR	RX-	NC
5	Ground	Ground	Ground
6	DSR	NC	NC
7	RTS	NC	NC
8	CTS	NC	NC
9	RI	NC	NC

CN10: COM3 & COM4 RS-232 Ports

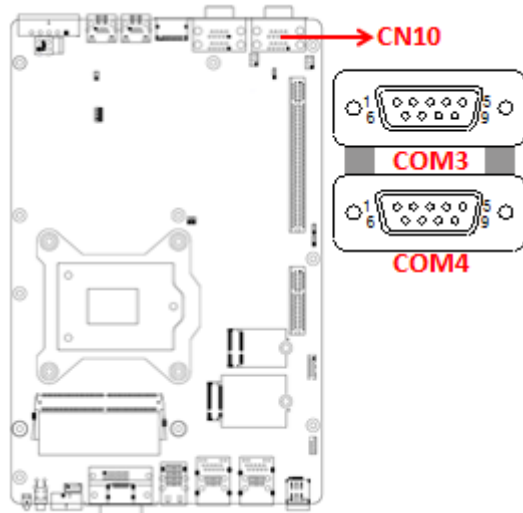

Pin	Signal Name	Pin	Signal Name
1	DCD, Data carrier detect	2	RXD, Receive data
3	TXD, Transmit data	4	DTR, Data terminal ready
5	Ground	6	DSR, Data set ready
7	RTS, Request to send	8	CTS, Clear to send
9	RI, Ring indicator	10	Key

J10: Digital I/O Connector

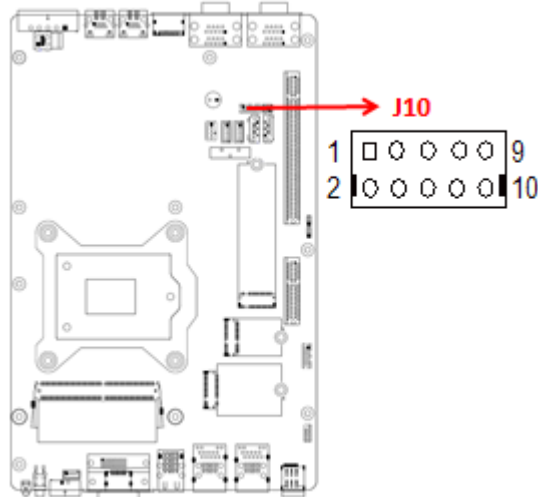

Pin	Signal Name	Pin	Signal Name
1	Ground	2	+5V
3	OUT3	4	OUT1
5	OUT2	6	OUT0
7	IN3	8	IN1
9	IN2	10	IN0

CPU_FAN1: CPU Fan Power Connector

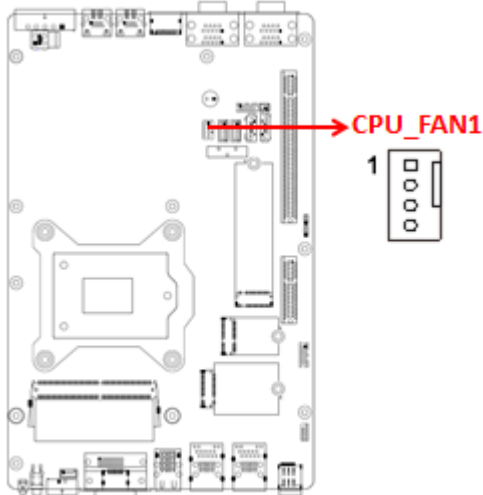

Pin	Signal Name	Pin	Signal Name
1	Ground	3	Rotation detection
2	+12V	4	Control

PCIE2: PCI-E x16 Connector

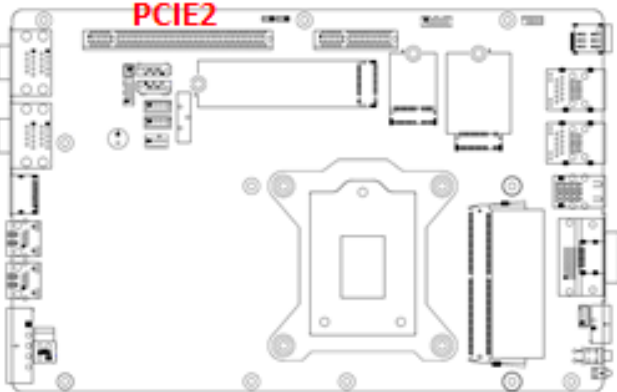

PCIE1: For PCI-E x1, USB2.0, SYS_FAN, SATA, COM TX/RX Signal

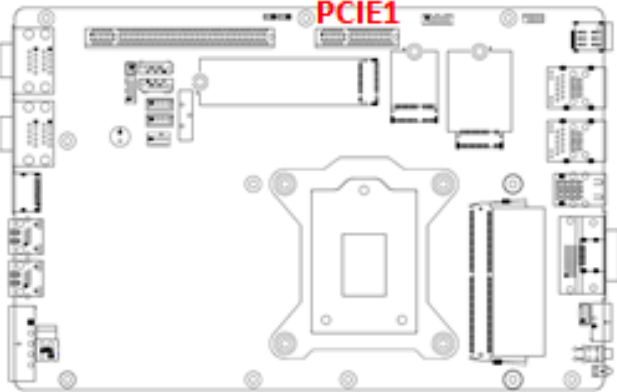

J14: DC-in Connector

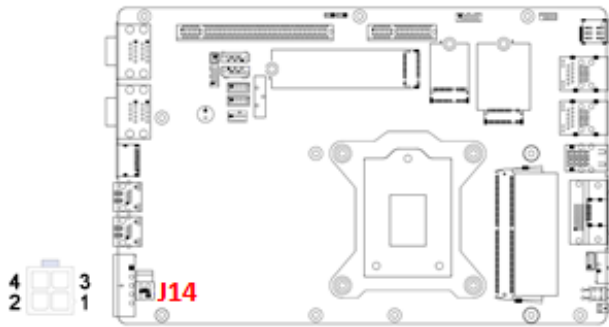

Pin	Signal Name
1	Power Ground
2	Case Ground
3	+12V to +24V
4	+12V to +24V

J15: DC-in Connector (Dinkle_5EHDRM-05P)

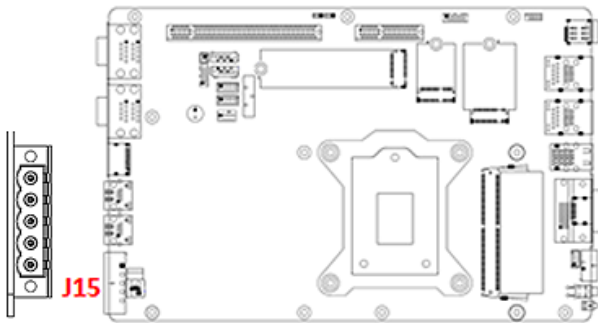

Pin	Signal Name
1	+12V to +24V
2	+12V to +24V
3	Case Ground
4	Power Ground
5	Power Ground

J1: iSMART Debug Connector (Factory use only)

J2: SPI Flash Connector (Factory use only) (2mm)

J12: LPC Debug Connector (Factory use only) (2mm)

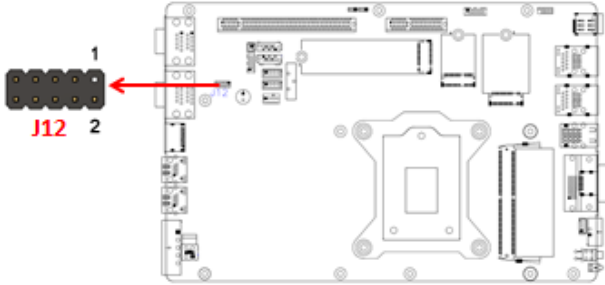

Pin	Signal Name	Pin	Signal Name
1	LPC_AD0	2	Reset#
3	LPC_AD1	4	LPC_FRAME#
5	LPC_AD2	6	+3.3V
7	LPC_AD3	8	Ground
9	CLK_33MHz	X	Protect Pin

J8, J9: SATA Power Connector (1600-4SD)

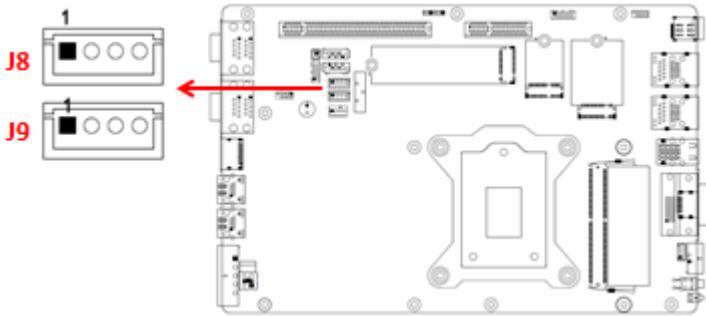

Pin	Signal Name
1	+5V
2	Ground
3	Ground
4	+12V

J11: Reset Button Connector (Techbest 2001-WS-02-LF)

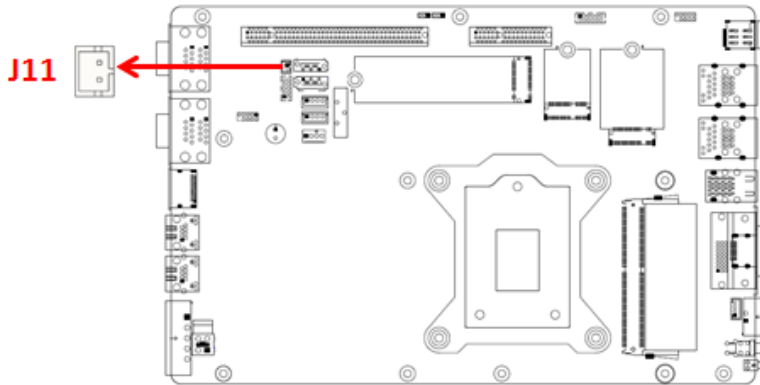

Pin	Signal Name
1	Reset BTN
2	Ground

SW1/ CN7: Power Button (with green LED) / Power Button Connector (Dinkle ECH350RM-02P)

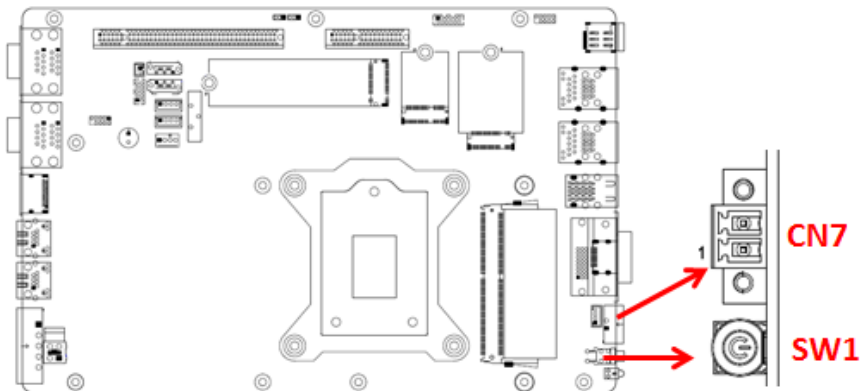

Pin	Signal Name
1	Power BTN
2	Ground

**CN2: RJ45 (I210IT) + USB3.1 Gen1 Connector
CN3: RJ45 (I219LM) + USB3.1 Gen1 Connector**

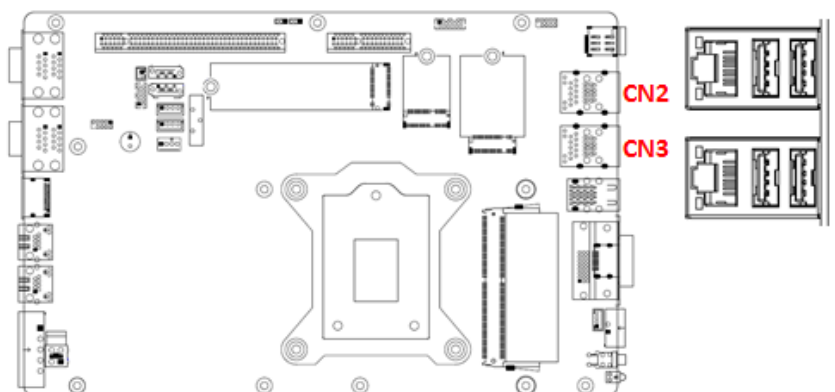

CN13 / CN14: RJ45 (I210IT, Supports PSE)

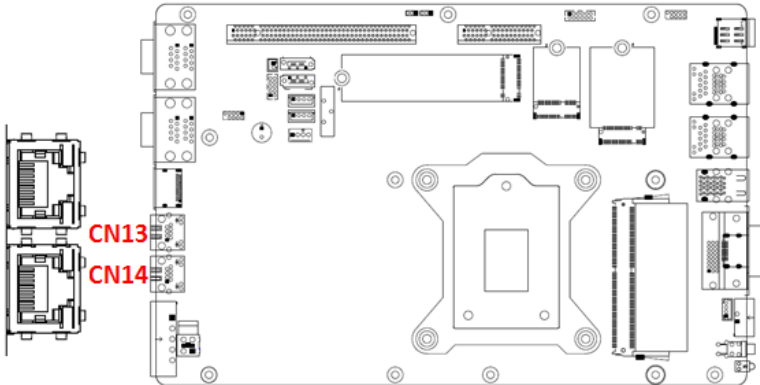

JP2: Flash Descriptor Security Override (Factory use only)

LED1: HDD LED

J5: Audio Connector

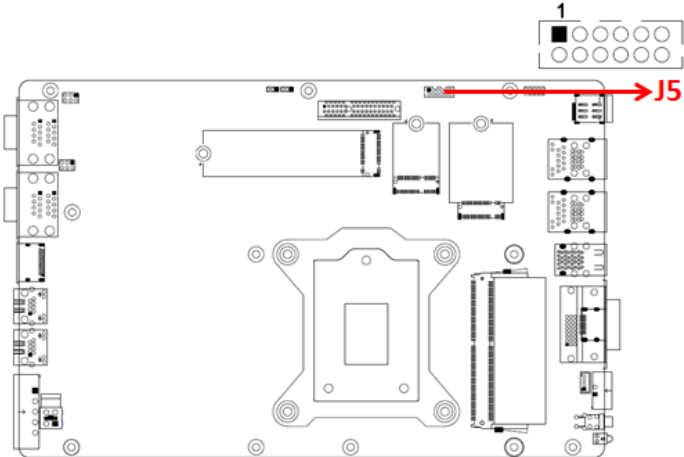

Pin	Assignment	Pin	Assignment
1	Lineout_L	2	Lineout_R
3	JD_FRONT	4	Ground
5	LINEIN_L	6	Linein_R
7	JD_LINEIN	8	Ground
9	MIC_L	10	MIC-R
11	JD_MIC1	12	Ground

This page is intentionally left blank.

Chapter 3

Driver Installation

The information provided in this chapter includes:

- Intel® Chipset Software Installation Utility
- Graphics Driver Installation
- HD Audio Driver Installation
- LAN Driver Installation
- Intel® Management Engine Driver Installation

3.1 Introduction

This section describes the installation procedures for software drivers. The software drivers are in the disk enclosed with the product package.

Note: After installing your Windows operating system, install the Intel® Chipset Software Installation Utility before proceeding with drivers installation.

3.2 Intel® Chipset Software Installation Utility

The Intel® Chipset drivers should be installed first before the software drivers to install INF files for Plug & Play function for the chipset components.

1. Insert the disk enclosed in the package. Click **Intel** and then **Intel(R) Coffeelake Chipset Drivers**.



2. Click **Intel(R) Chipset Software Installation Utility**.



3. In both the *Welcome* and *License Agreement* screens, click **Next** to continue.
4. When the Intel Chipset Device Software has been successfully installed, restart the computer when prompted.

3.3 Graphics Driver Installation

1. Insert the disk enclosed in the package. Click **Intel** and then **Intel(R) Coffeelake Chipset Drivers**.

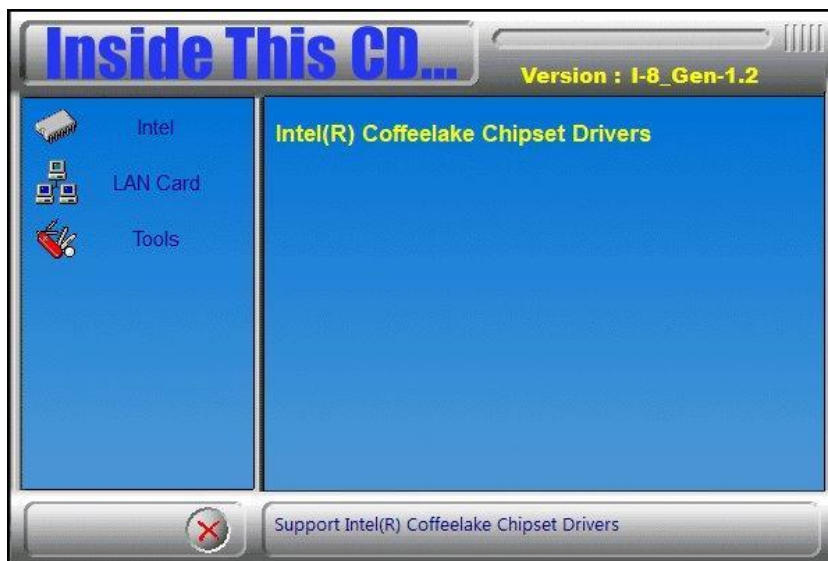

2. Click **Intel(R) HD Graphics Driver**.



3. In the *Welcome*, *License Agreement* and *Read File Information* screens, click **Next**.
4. When the driver has been completely installed, restart the computer when prompted.

3.4 HD Audio Driver Installation

1. Insert the disk enclosed in the package. Click **Intel** and then **Intel(R) Coffeelake Chipset Drivers**.

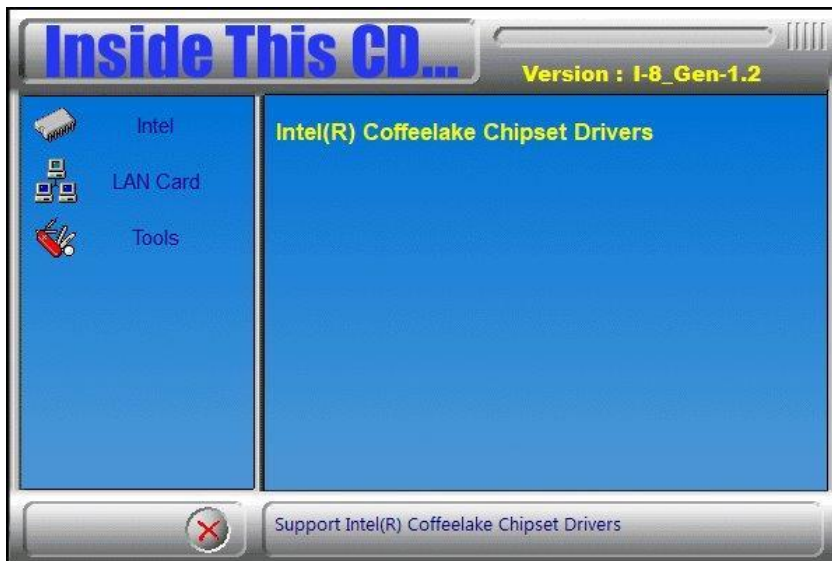

2. Click **Realtek High Definition Audio Driver**.

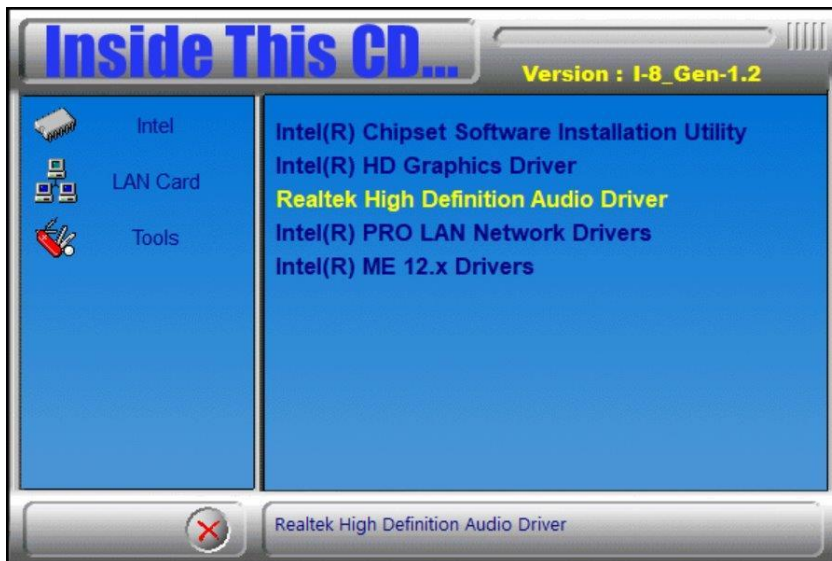

3. When the *Welcome* screen of the InstallShield Wizard appears, click **Next**.
4. When installation is complete, restart the computer when prompted.

3.5 LAN Driver Installation

1. Insert the disk enclosed in the package with the product. Click **LAN Card** and then **Intel(R) Coffeelake Chipset Drivers**



2. Click **Intel(R) PRO LAN Network Drivers..**



3. When the *Welcome and License Agreement* screens appear, click **Next**.
4. Tick the checkbox for **Drivers** to select the related drivers and click **Next**.
5. When the Install Wizard has completed the installation, restart the computer when prompted.

3.6 Intel® Management Engine Driver Installation

1. Insert the disk enclosed in the package. Click **Intel** and then **Intel(R) Skylake Chipset Drivers**.

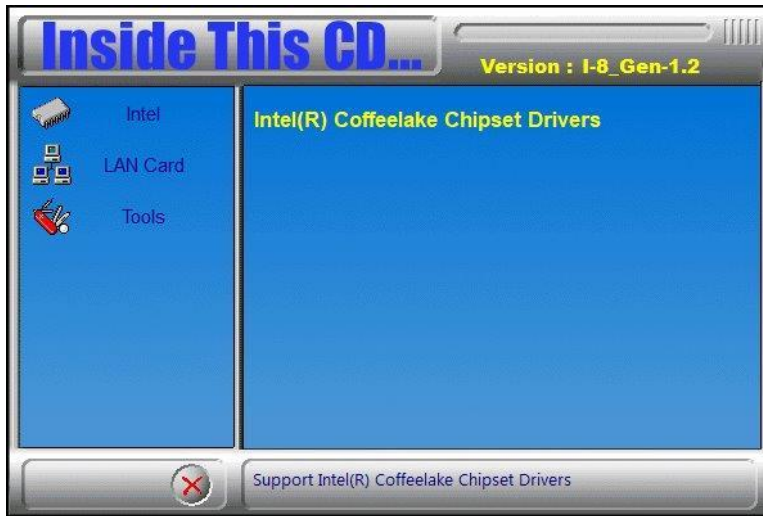

2. Click **Intel(R) ME 12.x Drivers**.



3. In the *Welcome*, *License Agreement* and *Destination Folder* screens, click **Next**.
4. When the Intel® Management Engine Components have been installed, click **Finish**.

Intel® Management Engine Components Completion

You have successfully installed the following components:

- Intel® Management Engine Interface
- Serial Over LAN
- Local Management Service
- Intel® Management and Security Status
- Intel® Trusted Connect Service

Chapter 4

BIOS Setup

This chapter describes the different settings available in the AMI BIOS that comes with the board. The topics covered in this chapter are as follows:

- Main Settings
- Advanced Settings
- Chipset Settings
- Security Settings
- Boot Settings
- Save & Exit

4.1 Introduction

The BIOS (Basic Input/Output System) installed in the ROM of your computer system supports Intel® processors. The BIOS provides critical low-level support for standard devices such as disk drives, serial ports and parallel ports. It also provides password protection as well as special support for detailed fine-tuning of the chipset controlling the entire system.

4.2 BIOS Setup

The BIOS provides a Setup utility program for specifying the system configurations and settings. The BIOS ROM of the system stores the Setup utility. When you turn on the computer, the BIOS is immediately activated. Press the key immediately allows you to enter the Setup utility. If you are a little bit late pressing the key, POST (Power On Self Test) will continue with its test routines, thus preventing you from invoking the Setup. You can also press <F7> to call the pop-up Boot menu immediately.

If you still need to enter Setup, restart the system by pressing the "Reset" button or simultaneously pressing the <Ctrl>, <Alt> and <Delete> keys. You can also restart by turning the system Off and back On again.

The following message will appear on the screen:

```
Press <DEL> to Enter Setup
```

In general, press the arrow keys to highlight items, <Enter> to select, the <PgUp> and <PgDn> keys to change entries, <F1> for help, and <Esc> to quit.

When you enter the BIOS Setup utility, the *Main Menu* screen will appear on the screen. The Main Menu allows you to select from various setup functions and exit choices.

Warning: It is strongly recommended that you avoid making any changes to the chipset defaults.

These defaults have been carefully chosen by both AMI and your system manufacturer to provide the absolute maximum performance and reliability. Changing the defaults could make the system unstable and crash in some cases.

4.3 Main Settings



BIOS Setting	Description
System Language	Choose the system default language.
System Date	Sets the date. Use the <Tab> key to switch between the data elements.
System Time	Set the time. Use the <Tab> key to switch between the data elements.

4.4 Advanced Settings

This section allows you to configure, improve your system and allows you to set up some system features according to your preference.

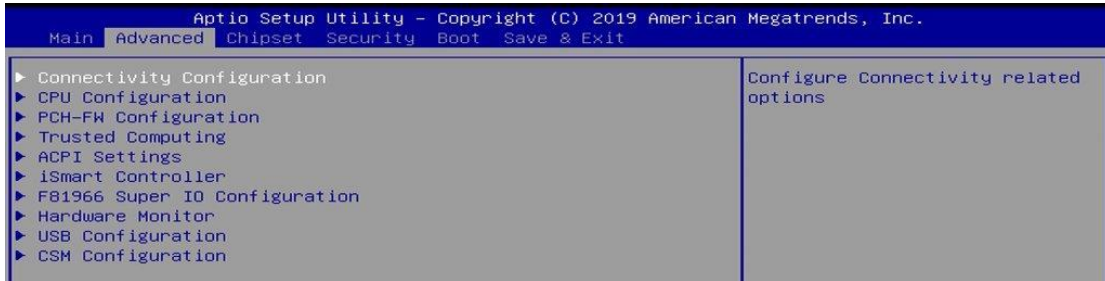

4.4.1 Connectivity Configuration



BIOS Setting	Description
CNVi Mode	This option configures Connectivity. [Auto Detection] means that if discrete solution is discovered it will be enabled by default. Otherwise, integrated solution (CNVi) will be enabled; [Disable Integrated] disables Integrated Solution.
MfUart1 type	This is a test option which allows configuration of UART type for WiFi side band communication.
CoExistence Manager	CoEx Manager mitigates radio coexistence issues between Intel WWAN (modem) and Intel WLAN (WiFi/BT). This should be enabled only if both WWAN and WLAN solutions are based on Intel components.
WWAN Enable	Enables/Disables M.w WWAN module. WWAN can only be enabled for re-work board.
Discrete Bluetooth Module	Seriallo UART0 needs to be enabled to select BT module.
Advanced Settings	Configure ACPI objects for wireless devices

4.4.2 CPU Configuration



BIOS Setting	Description
Intel (VMX) Virtualization Technology	When enabled, a VMM can utilize the additional hardware capabilities provided by Vanderpool Technology.
Active Processor Cores	Number of cores to enable in each processor package. Options: All, 1

4.4.3 PCH-FN Configuration



BIOS Setting	Description
ME State	When Disabled, ME will be put into ME Temporarily Disabled Mode.
AMI BIOS Features	When disabled AMT BIOS Features are no longer supported and user is no longer able to access MEBx Setup. Note: This option does not disable Manageability Features in FW.

4.4.4 Trusted Computing

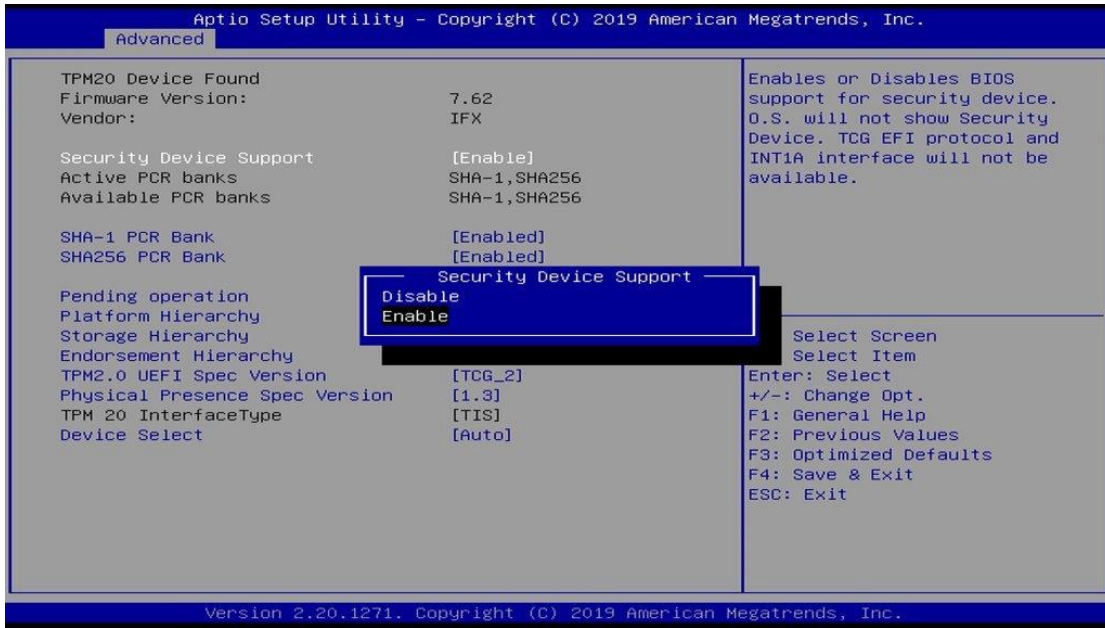

BIOS Setting	Description
Security Device Support	Enables / Disables BIOS support for security device. OS will not show security device. TCG EFI protocol and INTIA interface will not be available.
SHA-1 PCR Bank	Enable or Disable SHA-1 PCR Bank
SHA256 PCR Bank	Enable or Disable SHA256 PCR Bank
Pending operation	Schedule an operation for the security device. NOTE: Your computer will reboot during restart in order to change state of security device.
Platform Hierarchy	Enable or Disable Platform Hierarchy
Storage Hierarchy	Enable or Disable Storage Hierarchy
Endorsement Hierarchy	Enable or Disable Endorsement Hierarchy
TPM2.0 UEFI Spec Version	Select the TCG2 Spec version support: TCG_1_2: the compatible mode for Win8/Win10 TCG_2: Support new TCG2 protocol and even format for Win10 or later.
Physical Presence Spec Version	Select to tell OS to support PPI Spec Version 1.2 or 1.3. Note some HCK tests might not support 1.3.
Device Select	TPM 1.2 will restrict support to TPM 1.2 devices. TPM 2.0 will restrict to support TPM 2.0 devices. Auto will support both, with the default set to TPM 2.0 devices. If not found, TPM 1.2 devices will be enumerated.

4.4.5 ACPI Settings

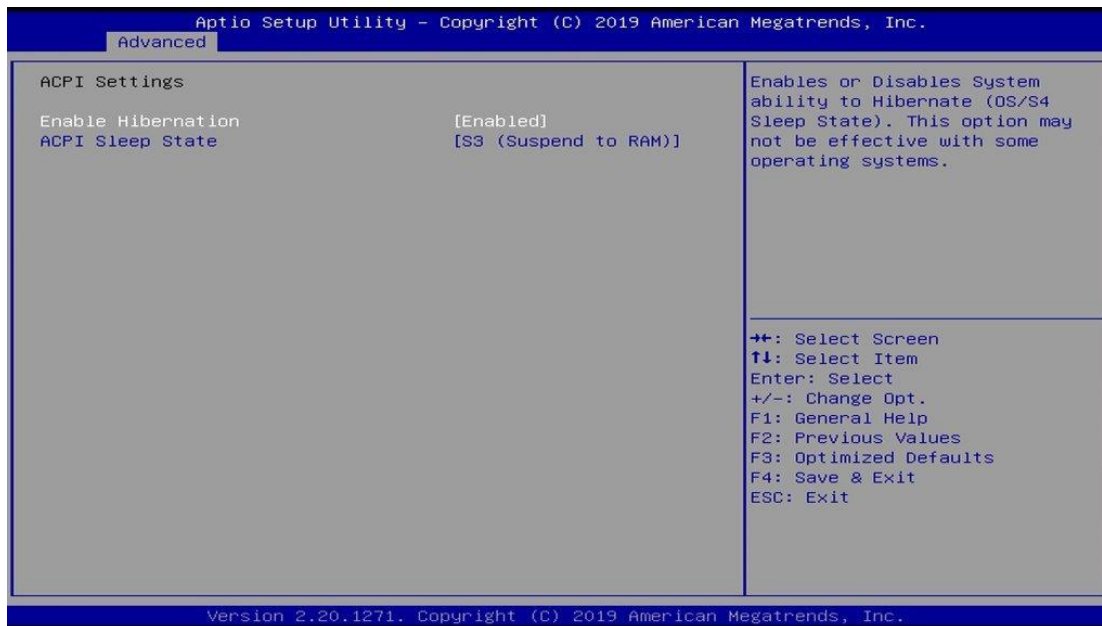

BIOS Setting	Description
Enable Hibernation	Enables / Disables the system ability to hibernate (OS/S4 Sleep State). This option may not be effective with some operating systems.
ACPI Sleep State	Selects the highest ACPI sleep state for the system will enter when the SUSPEND button is pressed. Options: Suspend Disabled S3 (Suspend to RAM)

4.4.6 iSmart Controller

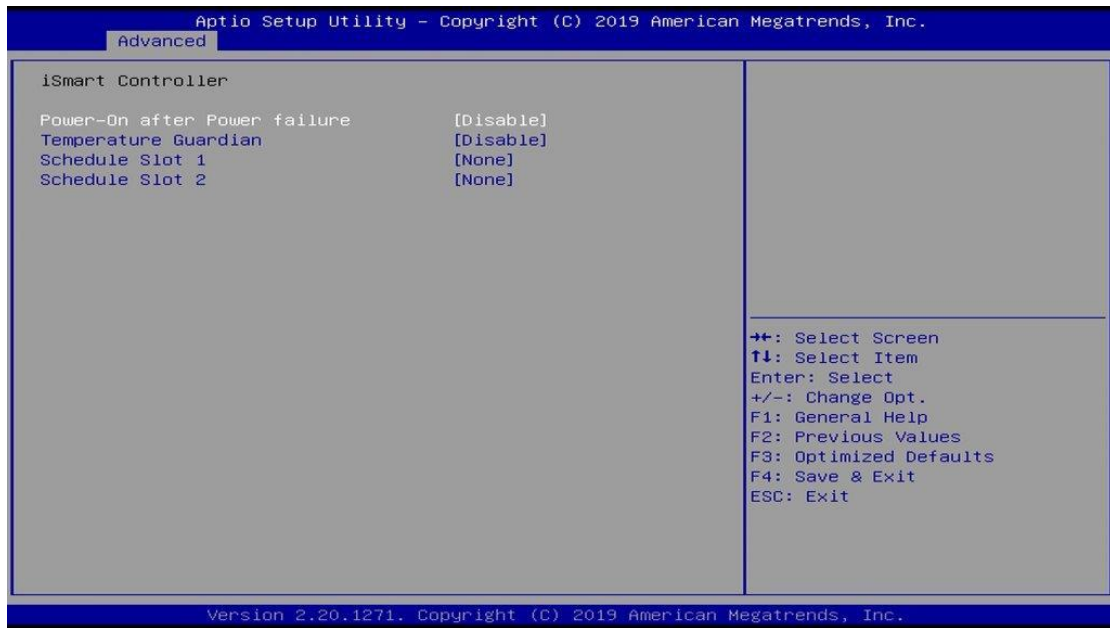

BIOS Setting	Description
Power-On after Power failure	Enables / Disables the system to be turned on automatically after a power failure.
Power Resume Delay	Enables / Disables to delay the time for system to turn on.
Temperature Guardian	Generate the reset signal when system hands up on POST.
Schedule Slot 1 / 2	<p>Sets up the hour / minute / day for the power-on schedule for the system.</p> <p>Options:</p> <ul style="list-style-type: none"> • None • Power On • Power On / Off <p>Important: If you would like to set up a schedule between adjacent days, configure two schedule slots.</p> <p>For example, if setting up a schedule from Wednesday 5 p.m. to Thursday 2 a.m., configure two schedule slots. But if setting up a schedule from 3 p.m to 5 p.m. on Wednesday, configure only a schedule slot.</p>

4.4.7 F81966 Super IO Configuration

Aptio Setup Utility - Copyright (C) 2019 American Megatrends, Inc.		
Advanced		
F81966 Super IO Configuration		Set Parameters of Serial Port 1 (COMA)
Super IO Chip	F81966	
▶ Serial Port 1 Configuration		
▶ Serial Port 2 Configuration		
▶ Serial Port 3 Configuration		
▶ Serial Port 4 Configuration		
▶ Serial Port 5 Configuration		
▶ Serial Port 6 Configuration		

Serial Port 1 Configuration		Enable or Disable Serial Port (COM)
Serial Port	[Enabled]	
Device Settings	IO=3F8h; IRQ=4;	
Change Settings	[Auto]	
SERIAL PORT MODE SELECT	[RS232 Mode]	

Serial Port 2 Configuration		Enable or Disable Serial Port (COM)
Serial Port	[Enabled]	
Device Settings	IO=2F8h; IRQ=3;	
Change Settings	[Auto]	
SERIAL PORT MODE SELECT	[RS232 Mode]	

Serial Port 3 Configuration		Enable or Disable Serial Port (COM)
Serial Port	[Enabled]	
Device Settings	IO=3E8h; IRQ=5;	
Change Settings	[Auto]	

Serial Port 4 Configuration		Enable or Disable Serial Port (COM)
Serial Port	[Enabled]	
Device Settings	IO=2E8h; IRQ=6;	
Change Settings	[Auto]	

Serial Port 5 Configuration		Enable or Disable Serial Port (COM)
Serial Port	[Enabled]	
Device Settings	IO=2F0h; IRQ=7;	
Change Settings	[Auto]	

Serial Port 6 Configuration		Enable or Disable Serial Port (COM)
Serial Port	[Enabled]	
Device Settings	IO=2E0h; IRQ=10;	
Change Settings	[Auto]	

BIOS Setting	Description
Serial Port Configuration	Sets parameters of Serial Ports. Enables / Disables the serial port and select an optimal setting for the Super IO device.

4.4.8 Hardware Monitor

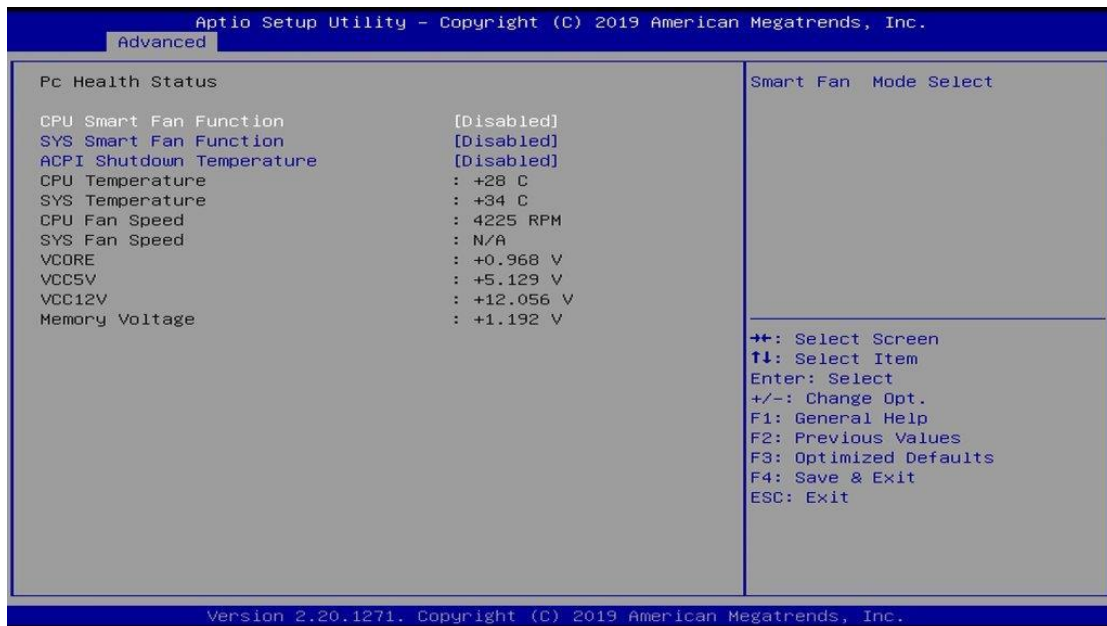

BIOS Setting	Description
CPU Smart Fan Control	Enables / Disables the CPU smart fan feature. Options: Disabled / 50°C / 60°C / 70°C / 80°C / 90°C
System Smart Fan Control	Enables / Disables the system smart fan feature. Options: Disabled / 50°C / 60°C / 70°C / 80°C / 90°C
ACPI Shutdown Temperature	Enables / Disables ACPI Shutdown Temperature feature. Options: Disabled, 70°C/ 75°C/ 80°C/ 85°C/ 90°C/ 95°C
Temperatures / Voltages	These fields are the parameters of the hardware monitoring function feature of the motherboard. The values are read-only values as monitored by the system and show the PC health status.

4.4.9 USB Configuration

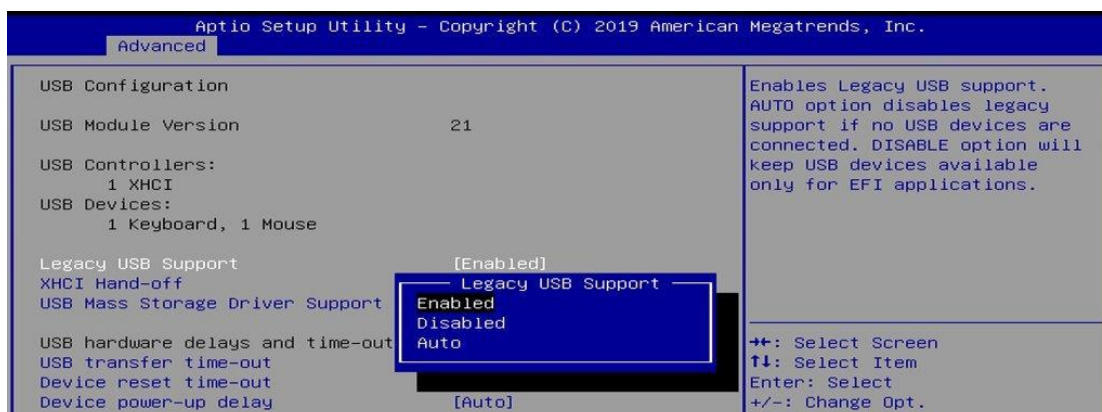

BIOS Setting	Description
Legacy USB Support	Enables Legacy USB support. <ul style="list-style-type: none"> • Auto disables legacy support if there is no USB device connected. • Disable keeps USB devices available only for EFI applications.
XHCI Hand-off	This is a workaround for OSes without XHCI hand-off support. The XHCI ownership change should be claimed by XHCI driver.
USB Mass Storage Driver Support	Enables / Disables the support for USB mass storage driver.
USB Transfer time-out	The time-out value for control, bulk, and Interrupt transfers. Options: 1 sec / 5 sec / 10 sec / 20 sec
Device reset time-out	Seconds of delaying execution of start unit command to USB mass storage device. Options: 10 sec / 20 sec / 30 sec / 40 sec
Device power-up delay	The maximum time the device will take before it properly reports itself to the Host Controller. Auto uses default value for a Root port it is 100ms. But for a Hub port, the delay is taken from Hub descriptor. Options: Auto / Manual

4.4.10 CSM Configuration



BIOS Setting	Description
CSM Support	Enables / Disables CSM support.
Network	Controls the execution of UEFI and Legacy Network OpROM. Options: Do not launch UEFI, Legacy

4.5 Chipset Settings

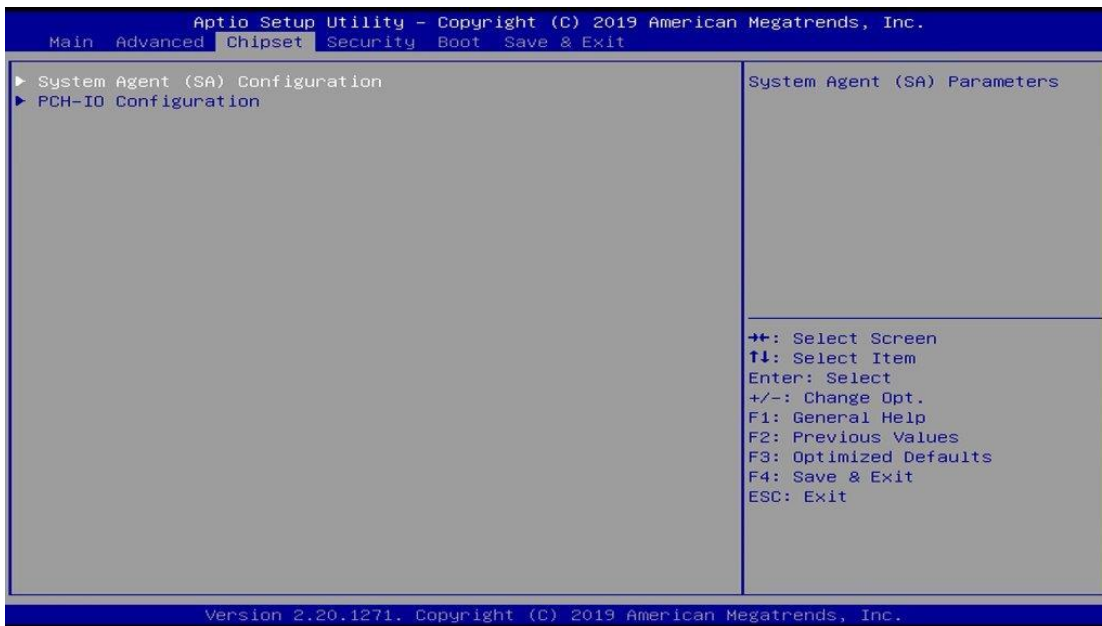

BIOS Setting	Description
System Agent (SA) Configuration	System Agent (SA) parameters
PCH-IO Configuration	PCH parameters

4.5.1 System Agent (SA) Configuration

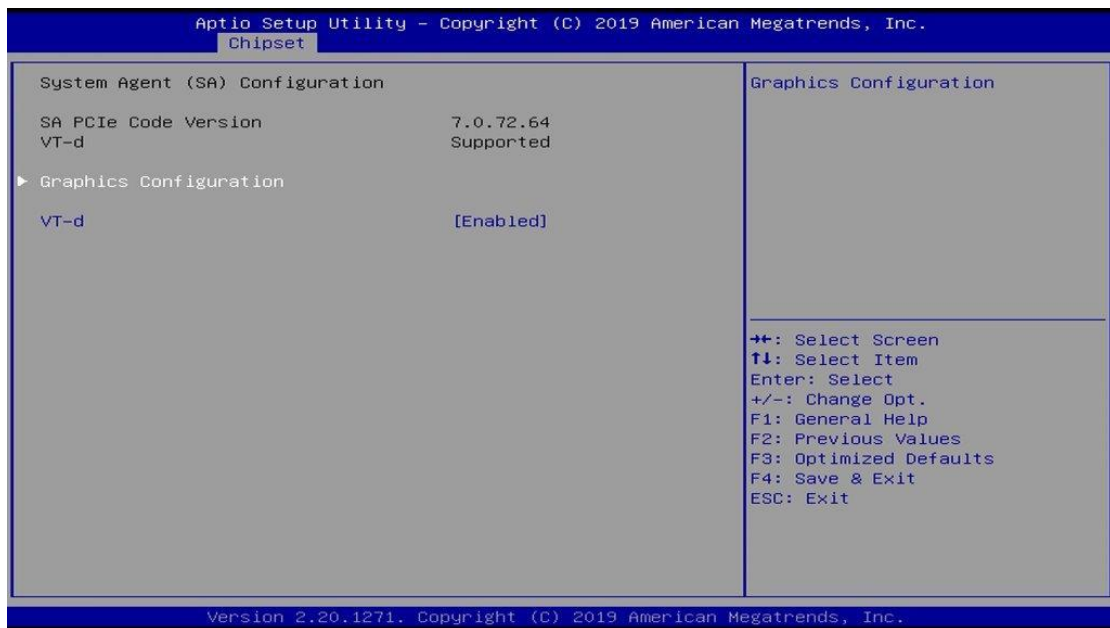

BIOS Setting	Description
VT-d	Checks if VT-d function on MCH is supported.
Graphics Configuration	Configures the graphics settings.
Memory Configuration	Displays the memory configuration parameters.

4.5.1.1. Graphics Configuration

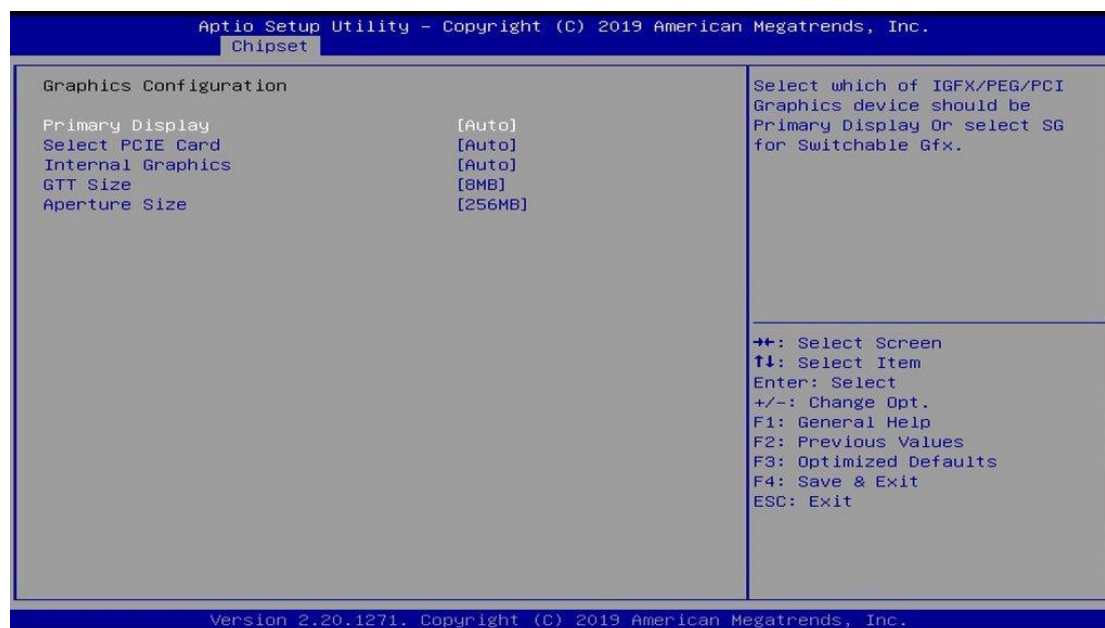

BIOS Setting	Description
Primary Display	Selects which of IGFX/PEG/PCI graphics device should be primary display, or selects SG for switchable Gfx.
Select PCIE Card	Select the card used on the platform. Auto: Skip GPIO based Power Enable to dGPU. Elk Creek 4: DGPU Power Enable = ActiveLow. PEG Eval: DGPU Power Enable = ActiveHigh
Internal Graphics	Keep IGFX enabled based on the setup options.
GTT Size	Sets the GTT size as 2 MB, 4 MB, or 8 MB.
Aperture Size	Select the aperture size. Note: Above 4 GB MMIO BIOS assignment is automatically enabled when selecting 2048 MB aperture. To use this feature, disable CSM support.

4.5.2 PCH-IO Configuration

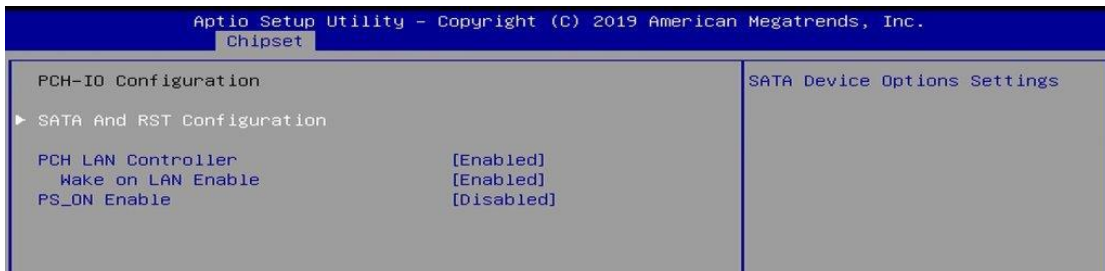

BIOS Setting	Description
SATA and RST Configuration	Configures SATA devices.
PCH LAN Controller	Enables / Disables onboard NIC.
Wake on LAN	Enables / Disables integrated LAN to wake the system.
PS_ON Enable	Enables / Disables PS_ON () support a new C10 state from the CPU on desktop SKUs that enables a lower power target that will be required by the California Energy Commission (CEC).

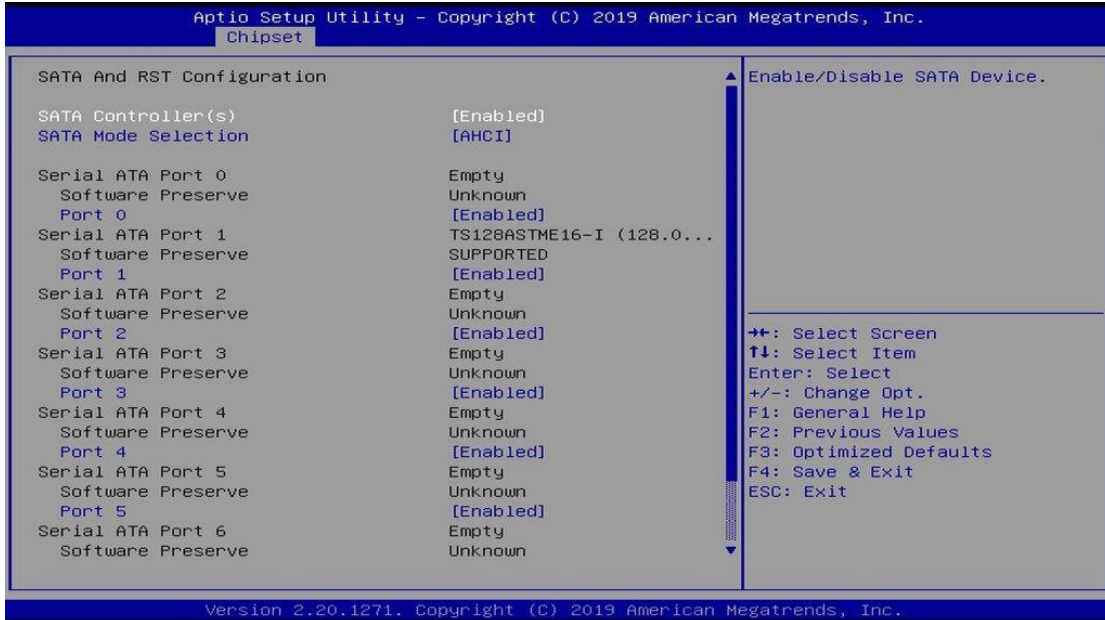

4.6 Security Settings

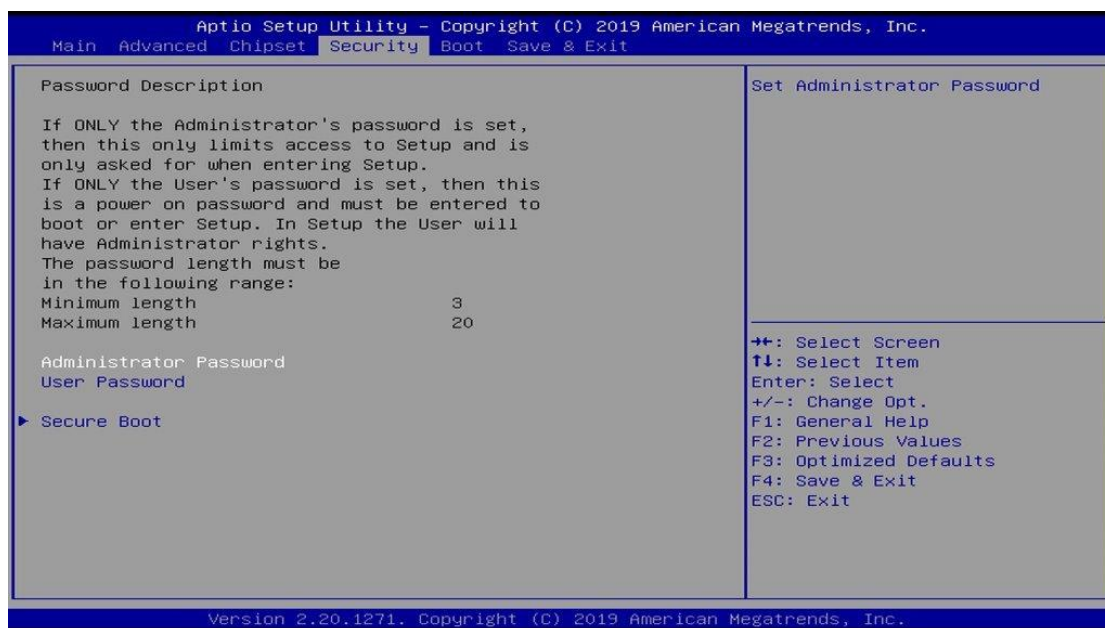

BIOS Setting	Description
Administrator Password	Sets an administrator password for the setup utility.
User Password	Sets a user password.
Secure Boot	Secure Boot feature is Active if Secure Boot is Enabled. Platform Key(PK) is enrolled and the System is in User mode. The mode change requires platform reset.
Secure Boot Mode	Secure Boot mode options: Standard or Custom. In Custom mode, Secure Boot Policy variables can be configured by a physically present user without full authentication.

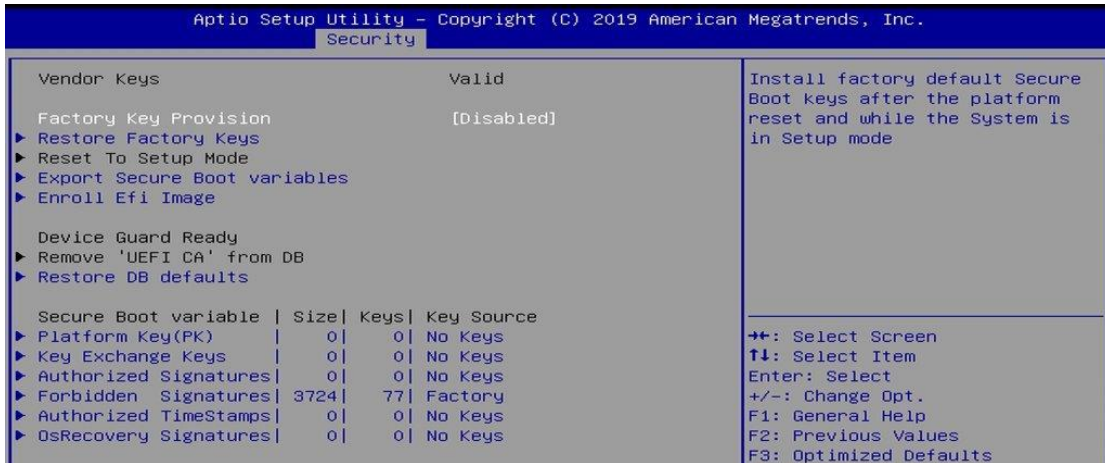

BIOS Setting	Description
Factory Key Provision	Install factory default Secure Boot keys after the platform reset and while the System is in Setup mode
Restore Factory Keys	Force System to User Mode. Install factory default Secure Boot key databases
Export Secure Boot variables	Copy NVRAM content of Secure Boot variables to files in a root folder on a file system device
Enroll Efi Image	Allow the image to run in Secure Boot mode. Enroll SHA256 Hash certificate of a PE image into Authorized Signature Database (db)
Platform Key(PK)	Enroll Factory Defaults or load certificates from a file: 1. Public Key Certificate: a) EFI_SIGNATURE_LIST b) EFI_CERT_X509 (DER) c) EFI_CERT_RSA2048 (bin) D) EFI_CERT_shaxxx 2. Authenticated UEFI Variable 3. EFI PE/COFF Image (SHA256) Key Source: Factory, External, Mixed

4.7 Boot Settings

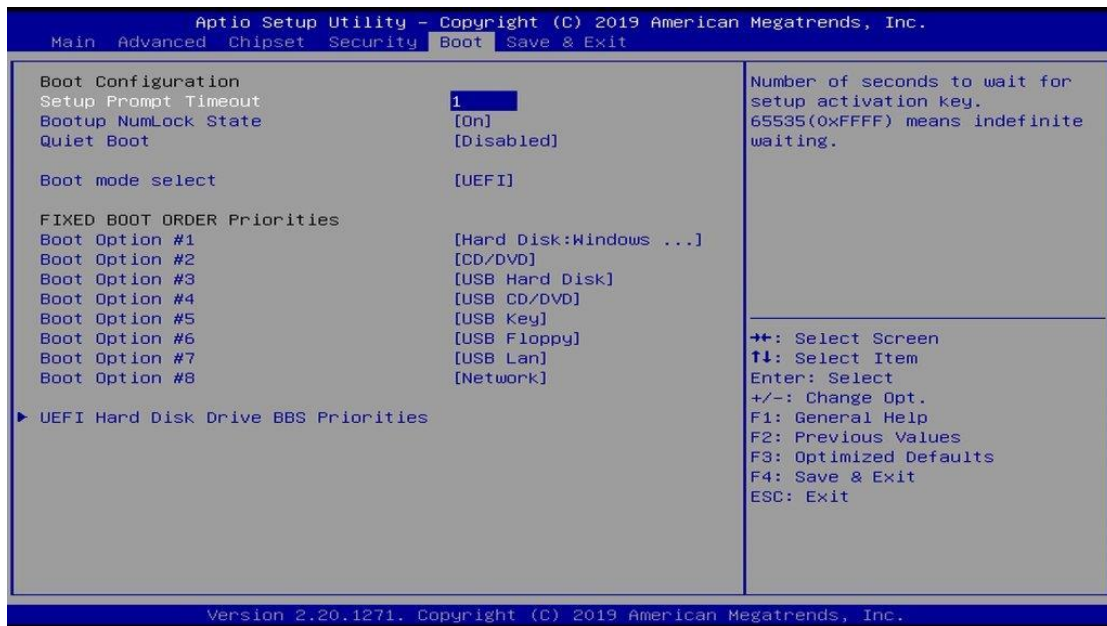

BIOS Setting	Description
Setup Prompt Timeout	Number of seconds to wait for setup activation key. 65535 (0xFFFF) means indefinite waiting.
Bootup NumLock State	Selects the keyboard NumLock state.
Quiet Boot	Enables / Disables Quiet Boot option.
Fast Boot	Enables / Disables boot with initialization of a minimal set of devices required to launch the active boot option. Has no effect for BBS boot options.
Boot mode select	Selects a Boot mode, Legacy / UEFI.
Fixed Boot Order Priorities	Sets the system boot order.
UEFI Hard Disk Drive BBS Priorities	Specifies the Boot Device Priority sequence from available UEFI Hard Disk Drives

4.8 Save & Exit Settings



BIOS Setting	Description
Save Changes and Exit	Exits system setup after saving the changes.
Discard Changes and Exit	Exits system setup without saving any changes.
Save Changes and Reset	Resets the system after saving the changes.
Discard Changes and Reset	Resets system setup without saving any changes.
Save Changes	Saves changes done so far to any of the setup options.
Discard Changes	Discards changes done so far to any of the setup options.
Restore Defaults	Restores / Loads defaults values for all the setup options.
Save as User Defaults	Saves the changes done so far as user defaults.
Restore User Defaults	Restores the user defaults to all the setup options.

Appendix

This section provides the mapping addresses of peripheral devices and the sample code of watchdog timer configuration.

- I/O Port Address Map
- Interrupt Request Lines (IRQ)
- Watchdog Timer Configuration

A. I/O Port Address Map

Each peripheral device in the system is assigned a set of I/O port addresses which also becomes the identity of the device. The following table lists the I/O port addresses used.

Address	Device Description
0x00000A00-0x00000A0F	Motherboard resources
0x00000A10-0x00000A1F	Motherboard resources
0x00000A20-0x00000A2F	Motherboard resources
0x0000002E-0x0000002F	Motherboard resources
0x0000004E-0x0000004F	Motherboard resources
0x00000061-0x00000061	Motherboard resources
0x00000063-0x00000063	Motherboard resources
0x00000065-0x00000065	Motherboard resources
0x00000067-0x00000067	Motherboard resources
0x00000070-0x00000070	Motherboard resources
0x00000080-0x00000080	Motherboard resources
0x00000092-0x00000092	Motherboard resources
0x000000B2-0x000000B3	Motherboard resources
0x00000680-0x0000069F	Motherboard resources
0x0000164E-0x0000164F	Motherboard resources
0x00000020-0x00000021	Programmable interrupt controller
0x00000024-0x00000025	Programmable interrupt controller
0x00000028-0x00000029	Programmable interrupt controller
0x0000002C-0x0000002D	Programmable interrupt controller
0x00000030-0x00000031	Programmable interrupt controller
0x00000034-0x00000035	Programmable interrupt controller
0x00000038-0x00000039	Programmable interrupt controller
0x0000003C-0x0000003D	Programmable interrupt controller
0x000000A0-0x000000A1	Programmable interrupt controller
0x000000A4-0x000000A5	Programmable interrupt controller
0x000000A8-0x000000A9	Programmable interrupt controller
0x000000AC-0x000000AD	Programmable interrupt controller
0x000000B0-0x000000B1	Programmable interrupt controller
0x000000B4-0x000000B5	Programmable interrupt controller
0x000000B8-0x000000B9	Programmable interrupt controller
0x000000BC-0x000000BD	Programmable interrupt controller

Address	Device Description
0x000004D0-0x000004D1	Programmable interrupt controller
0x00005000-0x00005FFF	Intel(R) PCI Express Root Port #7 - A33E
0x00001854-0x00001857	Motherboard resources
0x000003F8-0x000003FF	Communications Port (COM1)
0x000002F8-0x000002FF	Communications Port (COM2)
0x000003E8-0x000003EF	Communications Port (COM3)
0x000002E8-0x000002EF	Communications Port (COM4)
0x000002F0-0x000002F7	Communications Port (COM5)
0x000002E0-0x000002E7	Communications Port (COM6)
0x00001800-0x000018FE	Motherboard resources
0x00006000-0x0000603F	Intel(R) UHD Graphics 610
0x00000000-0x00000CF7	PCI Express Root Complex
0x00000D00-0x0000FFFF	PCI Express Root Complex
0x000000F0-0x000000F0	Numeric data processor
0x00006090-0x00006097	Standard SATA AHCI Controller
0x00006080-0x00006083	Standard SATA AHCI Controller
0x00006060-0x0000607F	Standard SATA AHCI Controller
0x0000FFF8-0x0000FFFF	Intel(R) Active Management Technology - SOL (COM7)
0x00002000-0x000020FE	Motherboard resources
0x00000040-0x00000043	System timer
0x00000050-0x00000053	System timer
0x00000060-0x00000060	Standard PS/2 Keyboard
0x00000064-0x00000064	Standard PS/2 Keyboard
0x00004000-0x00004FFF	Intel(R) PCI Express Root Port #8 - A33F
0x00003000-0x00003FFF	Intel(R) PCI Express Root Port #12 - A333
0x0000EFA0-0x0000EFBF	Intel(R) SMBus - A323

B. Interrupt Request Lines (IRQ)

Peripheral devices use interrupt request lines to notify CPU for the service required. The following table shows the IRQ used by the devices on board.

Level	Function
IRQ 0	System timer
IRQ 1	Standard PS/2 Keyboard
IRQ 3	Communications Port (COM2)
IRQ 4	Communications Port (COM1)
IRQ 5	Communications Port (COM3)
IRQ 7	Communications Port (COM4)
IRQ 10	Communications Port (COM5)
IRQ 11	Communications Port (COM6)
IRQ 11	Intel(R) Thermal Subsystem - A379
IRQ 11	Intel(R) SMBus - A323
IRQ 12	Microsoft PS/2 Mouse
IRQ 13	Numeric data processor
IRQ 14	Intel(R) Serial IO GPIO Host Controller - INT3450
IRQ 16	High Definition Audio Controller
IRQ 19	Intel(R) Active Management Technology - SOL (COM7)
IRQ 54~ IRQ 511	Microsoft ACPI-Compliant System
IRQ 4294967268	Intel(R) Management Engine Interface
IRQ 4294967269	Intel(R) Ethernet Connection (7) I219-LM
IRQ 4294967270-75	Intel(R) I210 Gigabit Network Connection #3
IRQ 4294967276-81	Intel(R) I210 Gigabit Network Connection #2
IRQ 4294967282-87	Intel(R) I210 Gigabit Network Connection
IRQ 4294967288	Intel(R) USB 3.1 eXtensible Host Controller - 1.10 (Microsoft)
IRQ 4294967289	Intel(R) UHD Graphics 610
IRQ 4294967290	Standard SATA AHCI Controller
IRQ 4294967291	Intel(R) PCI Express Root Port #12 - A333
IRQ 4294967292	Intel(R) PCI Express Root Port #8 - A33F
IRQ 4294967293	Intel(R) PCI Express Root Port #7 - A33E
IRQ 4294967294	Intel(R) PCIe Controller (x16) - 1901

C. Watchdog Timer Configuration

The Watchdog Timer (WDT) is used to generate a variety of output signals after a user programmable count. The WDT is suitable for the use in the prevention of system lock-up, such as when software becomes trapped in a deadlock. Under these sorts of circumstances, the timer will count to zero and the selected outputs will be driven.

Under normal circumstance, you will need to restart the WDT at regular intervals before the timer counts to zero.

Sample Code

```
//-----
//
// THIS CODE AND INFORMATION IS PROVIDED "AS IS" WITHOUT WARRANTY OF ANY
// KIND, EITHER EXPRESSED OR IMPLIED, INCLUDING BUT NOT LIMITED TO THE
// IMPLIED WARRANTIES OF MERCHANTABILITY AND/OR FITNESS FOR A
// PARTICULAR
// PURPOSE.
//
//-----
#include <dos.h>
#include <conio.h>
#include <stdio.h>
#include <stdlib.h>
#include "F81866.H"
//-----
int main (int argc, char *argv[]); void EnableWDT(int);
void DisableWDT(void);
//-----
int main (int argc, char *argv[])
{
    unsigned char bBuf;
    unsigned char bTime;
    char **endptr;

    char SIO;
    printf("Fintek 81866 watch dog program\n");
    SIO = Init_F81866();
    if (SIO == 0)
    {
        printf("Can not detect Fintek 81866, program abort.\n");
        return(1);
    }/if (SIO == 0)

    if (argc != 2)
    {
        printf(" Parameter incorrect!!\n");
        return (1);
    }
}
```

iBASE

```
bTime = strtol (argv[1], endptr, 10);
printf("System will reset after %d seconds\n", bTime);

if (bTime)
{   EnableWDT(bTime); }
else
{   DisableWDT(); }
return 0;
}
//-----
void EnableWDT(int interval)
{
    unsigned char bBuf;

    bBuf = Get_F81866_Reg(0x2B);
    bBuf &= (~0x20);
    Set_F81866_Reg(0x2B, bBuf);           //Enable WDTO

    Set_F81866_LD(0x07);                 //switch to logic device 7
    Set_F81866_Reg(0x30, 0x01);         //enable timer

    bBuf = Get_F81866_Reg(0xF5);
    bBuf &= (~0x0F);
    bBuf |= 0x52;
    Set_F81866_Reg(0xF5, bBuf);         //count mode is second
    Set_F81866_Reg(0xF6, interval);     //set timer
    bBuf = Get_F81866_Reg(0xFA);
    bBuf |= 0x01;
    Set_F81866_Reg(0xFA, bBuf);         //enable WDTO output

    bBuf = Get_F81866_Reg(0xF5);
    bBuf |= 0x20;
    Set_F81866_Reg(0xF5, bBuf);         //start counting
}
//-----
void DisableWDT(void)
{
    unsigned char bBuf;
    Set_F81866_LD(0x07);                 //switch to logic device 7
    bBuf = Get_F81866_Reg(0xFA);
    bBuf &= ~0x01;
    Set_F81866_Reg(0xFA, bBuf);         //disable WDTO output

    bBuf = Get_F81866_Reg(0xF5);
    bBuf &= ~0x20;
    bBuf |= 0x40;
    Set_F81866_Reg(0xF5, bBuf);         //disable WDT
}
//-----
```

```

//-----
//
// THIS CODE AND INFORMATION IS PROVIDED "AS IS" WITHOUT WARRANTY OF ANY
// KIND, EITHER EXPRESSED OR IMPLIED, INCLUDING BUT NOT LIMITED TO THE
// IMPLIED WARRANTIES OF MERCHANTABILITY AND/OR FITNESS FOR A
// PARTICULAR
// PURPOSE.
//
//-----
#include "F81866.H"
#include <dos.h>
//-----
unsigned int F81866_BASE; void Unlock_F81866 (void); void Lock_F81866 (void);
//-----
unsigned int Init_F81866(void)
{
    unsigned int result;
    unsigned char ucDid;

    F81866_BASE = 0x4E;
    result = F81866_BASE;

    ucDid = Get_F81866_Reg(0x20);
    if (ucDid == 0x07) //Fintek 81866
    {
        goto Init_Finish;
    }

    F81866_BASE = 0x2E;
    result = F81866_BASE;

    ucDid = Get_F81866_Reg(0x20);
    if (ucDid == 0x07) //Fintek 81866
    {
        goto Init_Finish;
    }

    F81866_BASE = 0x00;
    result = F81866_BASE;

Init_Finish:
    return (result);
}
//-----
void Unlock_F81866 (void)
{
    outportb(F81866_INDEX_PORT, F81866_UNLOCK);
    outportb(F81866_INDEX_PORT, F81866_UNLOCK);
}
//-----
void Lock_F81866 (void)
{
    outportb(F81866_INDEX_PORT, F81866_LOCK);
}
//-----
void Set_F81866_LD( unsigned char LD)
{
    Unlock_F81866();
}

```

iBASE

```
    outportb(F81866_INDEX_PORT, F81866_REG_LD);
    outportb(F81866_DATA_PORT, LD); Lock_F81866();
}
//-----
void Set_F81866_Reg( unsigned char REG, unsigned char DATA)
{
    Unlock_F81866();
    outportb(F81866_INDEX_PORT, REG);
    outportb(F81866_DATA_PORT, DATA);
    Lock_F81866();
}
//-----
unsigned char Get_F81866_Reg(unsigned char REG)
{
    unsigned char Result;
    Unlock_F81866();
    outportb(F81866_INDEX_PORT, REG);
    Result = inportb(F81866_DATA_PORT);
    Lock_F81866();
    return Result;
}
//-----

//-----
//
// THIS CODE AND INFORMATION IS PROVIDED "AS IS" WITHOUT WARRANTY OF ANY
// KIND, EITHER EXPRESSED OR IMPLIED, INCLUDING BUT NOT LIMITED TO THE
// IMPLIED WARRANTIES OF MERCHANTABILITY AND/OR FITNESS FOR A
// PARTICULAR
// PURPOSE.
//
//-----
#ifndef    F81866_H
#define    F81866_H    1
//-----
#define    F81866_INDEX_PORT    (F81866_BASE)
#define    F81866_DATA_PORT    (F81866_BASE+1)
//-----
#define    F81866_REG_LD    0x07
//-----
#define    F81866_UNLOCK    0x87
#define    F81866_LOCK    0xAA
//-----
unsigned int Init_F81866(void);
void Set_F81866_LD( unsigned char);
void Set_F81866_Reg( unsigned char, unsigned char); unsigned char
Get_F81866_Reg( unsigned char);
//-----
#endif //    F81866_H
```