

ASLAN-W812C-2930G2

Fanless 11.6" Industrial Panel PC with Intel® Bay Trail SoC Processor



Features

- High Resolution LCD Display w/ LED Backlight
- Flat panel with projected capacitive touchscreen
- Front panel compliant with IP65
- Anti-scratch surface: 7H hardness
- Slim and Compact Design
- Mini PCIe expansion slot support
- Fanless cooling system
- Cable-less Design
- Low power consumption
- DC-12V Power Input

System

CPU	Intel® N2930 Quad-Core™ Processor 1.83GHz 2GB DDR3L SO-DIMM RAM module installed
Memory	1 x DDR3L SO-DIMM Socket, supporting 1600MHz SDRAM up to 8GB
LAN	2 x Intel® I210AT GbE controllers
Watchdog Timer	1~255 levels reset

Storage

Device	1 x mSATA for SATA interface SSD Supports 300MB/s HDD transfer rate
--------	--

Audio

Type	1x Mic-in / 1x Line out
------	-------------------------

LCD Display

Size/Type	11.6" TFT LCD Panel
Max. Resolution	1920 x 1080
Max. Colors	16.7M
Luminance	300 cd/m ²
Touch Screen	Projected capacitive touch panel
View Angle (U/D/R/L)	85°/85°/85°/85°

Power System

Power Input	DC 12V input with DC jack
-------------	---------------------------

Certification

EMC / EMI	CE, FCC Class A
-----------	-----------------

Expansion

Expansion Bus	1 x Full-Size mPCIe (PCIex1+USB2.0) 1 x Half-Size mPCIe (PCIex1 Lane only)
---------------	---

External I/O

USB Ports	1 x Type-A USB 3.0 port 1 x Type-A USB 2.0 port
LAN	2 x RJ-45 GbE ports
DVI	1 x DVI-I connector
WiFi	1 x SMA antenna holes for optional WiFi function

Mechanical

Mounting Type	VESA-75 / 100 Mounting with Bracket
Chassis	Aluminum front bezel and SECC steel chassis
Dimension (W x H x D)	306.00 x 206.00 x 39.50 mm (12.05" x 8.11" x 1.56")
Weight (Net)	2.1 kg (4.63 lb)

Environmental

Operating Temp.	-20°C ~ 55°C (-4°F ~ 140°F)
Storage Temp.	-30°C ~ 70°C (-22°F ~ 158°F)
Operating Humidity	10 ~ 95% RH @ 60°C (non-condensing)
Vibration	5 ~ 500Hz, 1Grms Random (with CFast/SSD)
Shock	Operating 10G, 11ms Non-operating 30G, 11ms (with CFast/SSD)

OS Support

W7 Pro / WS7E / W8.1 Industry / Linux: Ubuntu

Ordering Information

ASLAN-W812C-2930G2 11.6" Intel® N2930 Quad-Core™ Processor industrial panel PC with 2GB Memory



Dimensions

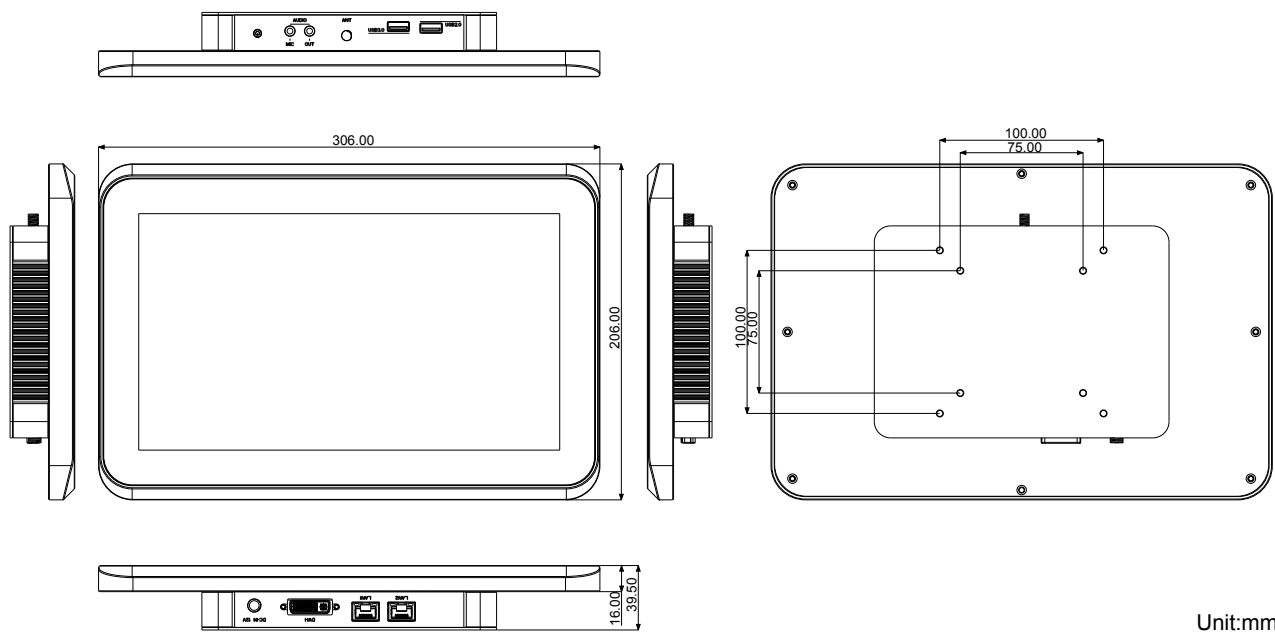







Unit:mm

Optional Accessories

PAC-P060W-01	60W AC/DC Adapter Kit	
--------------	-----------------------	---

Optional Accessories (CTOS* Kit)

WiFi-AT2300	Atheros AR9462 WiFi module w/ 20cm internal wiring	
ANT-D11	1 x Wi-Fi Dual-band 2.4G/5G antenna	
MM-3L-2G	Industrial DDR3L-1333 2GB SO-DIMM SDRAM	
MM-3L-4G	Industrial DDR3L-1333 4GB SO-DIMM SDRAM	
32GB SSD	mSATA MLC 32GB	
64GB SSD	mSATA MLC 64GB	

*CTOS means Configure-to-Order Service.