



# FABS

7", 10.1", 12.1", 15", 17", 19", and 21.5" Food Industrial Panel PC.

## User Manual

**Release Date**

**Revision**

Mar. 2018

V1.0

©2018 Aplex Technology, Inc.

All Rights Reserved.

Published in Taiwan

Aplex Technology, Inc.

15F-1, No.186, Jian Yi Road, Zhonghe District, New Taipei City 235, Taiwan

Tel: 886-2-82262881 Fax: 886-2-82262883 URL: <http://www.aplertec.com/zh/home.php>

# Revision History

Reversion	Date	Description
0.1	2017/11/29	For Preliminary Release
1.0	2018/03/15	Official Version

# Warning!

---

This equipment generates, uses and can radiate radio frequency energy and if not installed and used in accordance with the instructions manual, it may cause interference to radio communications. It has been tested and found to comply with the limits for a Class A computing device pursuant to FCC Rules, which are designed to provide reasonable protection against such interference when operated in a commercial environment. Operation of this equipment in a residential area is likely to cause interference in which case the user at his own expense will be required to take whatever measures may be required to correct the interference.

Electric Shock Hazard – Do not operate the machine with its back cover removed. There are dangerous high voltages inside.

## Disclaimer

**This information in this document is subject to change without notice. In no event shall Apex Technology Inc. be liable for damages of any kind, whether incidental or consequential, arising from either the use or misuse of information in this document or in any related materials.**

# Instruction Guide

## SAFETY INSTRUCTIONS

Read these instructions carefully, and look at the equipment to become familiar with the device before trying to install, operate, or maintain it. The following special messages may appear throughout this documentation or on the equipment that are warn of potential hazards and to call attention to information on clarifying or simplifying the procedure.



This is the safety alert symbol. It is the purpose of alerting you to potential hazards. Obey all safety information that follows this symbol to avoid possible injury or death.



This is the high temperature alert symbol. It is warning you attention the high temperature position of product when you operating or repairing the system. Before you repair or clean it. We suggest you waiting for the machine to be cooler

## PLEASE NOTE

Electrical equipment should be installed, operated, serviced, and maintained by qualified personnel only. No responsibility is assumed by Digital Electronics Corporation for any consequences arising out of the use of this material. A qualified person is one who has skills and knowledge related to the construction, operation and installation of electrical equipment, and has received safety training to recognize and avoid the hazards involved.

## DISCLAIMER of LIABILITY

We have reviewed the contents of this publication to ensure the description of hardware and software to meet the consistency. Since the many variables associated with particular installation, we cannot guarantee all condition. Furthermore, we are not responsible for any modified, altered or reconstructed equipment if users did it.

## SAFETY INFORMATION

- There is no perfect solution to move heavy objects comfortably, we suggest you to seek the support tools to help, such as a trolley or stacker before you moving heavy objects.
- We suggest you to take a slow and smooth action when you're moving the objects to avoid strain your back and muscles.

- Please be careful about the surrounding and ground conditions while you moving the heavy objects. In meanwhile, please also notice the place you placing the objects is appropriate.
- Never allow fluids, metal filings or wiring debris to enter any openings in the operator panel. This may cause fire or electrical shock.
- Storing the operator panel under the environmental temperature is lower/higher than recommended temperature in this; otherwise, it may cause the breakdown of LCD display.
- Please turn off the product before you do any repair, clean, maintenance, and disassembly of the situations.
- Electrostatically sensitive components include almost all electrical, electronic, optoelectronic and electromechanical components. These components are sensitive to overvoltage because of the technical reasons and their function may be impaired or destroyed by electrostatic discharge. Observe the regulations to carefully manage the ESD components.
- We can promise our product and some of the electronic components that observe the regulation of EMI certification but we suggest to operate the systems by qualified operator or the personnel who doesn't wear the pacemaker.
- Keeping slots and openings in the product for ventilation and should never be blocked or covered to ensure the reliable operation of the product and protect it from overheating.
- The front panels of these products have approval by IP66/IP69K level, defined in international standard EN60529 of test and verify. We suggest keeping products in ventilation and in a dry environment; please follow our cleaning guide when you need to clean the product.
- Make sure you follow the local environmental regulations when your products need to be scrapped.
- Contact your local government for understanding the inform on regarding the waste systems available. We suggest to separate electrical appliance from general trash and follow handling waste disposal systems.

**FABS Series has approval through this certification for your reference:**

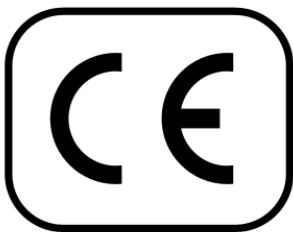

<b>Applicable Standards:</b>	EN 55011: 2009 + A1: 2010 (Group 1, Class A)	EN 61000-6-2: 2005 / AC: 2005
	EN 61000-6-4: 2007 + A1: 2011	IEC 61000-4-2: 2008
	EN 61000-3-2: 2014	IEC 61000-4-3: 2006 + A1: 2007 + A2: 2010
	EN 61000-3-3: 2013	IEC 61000-4-4: 2012
		IEC 61000-4-5: 2014
		IEC 61000-4-6: 2013
		IEC 61000-4-8: 2009
		IEC 61000-4-11: 2004

# Table of Contents

Revision History.....	1
Warning!/Caution.....	2
Instruction Guide.....	3

## Chapter 1 Getting Started

1.1 Features.....	7
1.2 Specifications.....	7
1.3 Dimensions.....	9
1.4 Brief Description of FABS Series.....	13

## Chapter 2 Installation and Comfort Guide

2.1 Adjust your monitor and posture.....	14
2.2 Panel mounting your monitor.....	15

## Chapter 3 Hardware

3.1 Motherboard Introduction.....	16
3.2 Specifications.....	16
3.3 Jumpers and Connectors Location.....	19
3.4 Jumpers Setting and Connectors.....	20

## Chapter 4 BIOS Setup

4.1 Operations after POST Screen.....	35
4.2 BIOS Setup Utility.....	35
4.3 Main Settings.....	36
4.4 Advanced Settings.....	37
4.5 Chipset Settings.....	44
4.6 Security Settings.....	46
4.7 Boot Settings.....	47
4.8 Save & Exit Settings.....	48

## Chapter 5 Installation of Drivers

5.1 Intel (R) Atom™ SoC Chipset .....	51
5.2 Intel (R) VGA Chipset.....	54
5.3 Realtek ALC662 HD Audio Driver Installation.....	58
5.4 Com Driver.....	60

**Figures**

---

Figure 1.1: Dimensions of FABS-807P/G(H).....9

Figure 1.2: Dimensions of FABS-810P/G(H).....9

Figure 1.3: Dimensions of FABS-812P/G(H).....10

Figure 1.4: Dimensions of FABS-815P/G(H).....10

Figure 1.5: Dimensions of FABS-817P/G(H).....11

Figure 1.6: Dimensions of FABS-819P/G(H).....11

Figure 1.7: Dimensions of FABS-821P/G(H).....12

Figure 1.8: Front View of FABS Series.....13

Figure 1.9: Rear View of FABS Series.....13

Figure 1.10: Panel Mounting of FABS Series.....15

Figure 2.1: Motherboard Dimensions.....18

Figure 2.2: Jumpers and Connectors Location-Board Top.....19

Figure 2.3: Jumpers and Connectors Location-Board Bottom.....19

## 1.1 Features

- Intel® Celeron Processor N2930
- 7"/10.1"/12.1"/15"/17"/19"21.5" Food Industrial Panel PC
- Flat front panel touch screen with IP66/IP69K grade.
- Onboard 4GB DDR3L 1600MHz
- DC 9-36V wide range power input
- 304 Stainless steel design.

## 1.2 Specifications

	FABS-807 P/G(H)	FABS-810 P/G(H)	FABS-812 P/G(H)	FABS-815 P/G(H)	FABS-817 P/G(H)	FABS-819 P/G(H)	FABS-821 P/G(H)
<b>System</b>							
CPU	Onboard Intel Celeron N2930 1.83GHz Processor						
Chipset	SoC						
Memory	Onboard 4GB DDR3L 1600 MHz						
<b>IO Port</b>							
Outside I/O port	2 x USB 3.0 type A 2 x GbE LAN RJ-45 1 x RS-232 DB-9(COM2) 1 x DB-9 RS-232/422/485 (Default RS-232)(COM1) 1 x Audio Line Out 1 x HDMI Port (without printing, without hole) 1 x 3-pin DC 9-36V power input terminal 1 x 2-pin connector for power on/off button Option TB-528 Series						
<b>Storage Space</b>							
Storage	1 x SD card slot on board 1 x MO-297 SSD space (only for 7") 1 x 2.5" SATA HDD/SSD space (Easy Accessible)						
<b>Display</b>							
Display type	7"	10.1"	12.1"	15"	17"	19"	21.5"
Max. Resolution	800x480	1280 x 800	1024x768	1024 x 768	1280x1024	1280x1024	1920x1080
Max. Color	262K	12.7M	16.2M	16.7M	16.2M	16.2M	16.7M



Luminance (cd/m <sup>2</sup> )	350	350/300	500	420	350	350	250
Contrast Ratio	400:1	8:00/1300:1	700:1	800:1	1000:1	1000:1	3000:1
Viewing Angle	V:110/H:14 0	V:170/H:17 0	H: 160/V:140	H:160/ V:160	H: 170/V:160	H: 170/V:165	H: 178/V:178
Backlight Lifetime	40,000	N/A	50,000	50,000	30,000	50,000	30,000

#### Touch Screen

Type	Project capacitive						
interface	USB over 90%						

#### Power

Power Input	DC 9-36V						
Power Consumption	21.6W	19.8W	TBD	29.8W	TBD	TBD	32.4W

#### Mechanical

Construction	306 Stainless Steel Chassis 316 Stainless Steel Chassis (Option)						
Mounting	Panel Mount by optimized frame design						
Dimension (mm)	217 x 163 x 40	296 x 200 x 46.9	331 x 257 x 52	422 x 322 x 54.1	449.4 x 358.4 x 63.8	485 x 398 x 63.8	573.8 x 378.8 x 59.8
Net Weight (Kg)	1.7	2.5	TBD	5.2	TBD	TBD	8

#### Environmental

Operating temperature	0~50°C						
Storage temperature	-20~60°C						
Storage humidity	10 to 90% @ 40°C, non- condensing						
Vibration	1G / 5 ~ 500Hz (Random) / Operation						
Shock	15G peak acceleration(11 msec. duration)/operation						
Altitude	0 ~ 1000m						
Operate altitude	0.6~1.7m						
Certification	CE / FCC Class A						

#### Operating System Support

OS Support	Windows 10 IOT Enterprise LTSB 2016						
------------	-------------------------------------	--	--	--	--	--	--

### 1.3 Dimensions

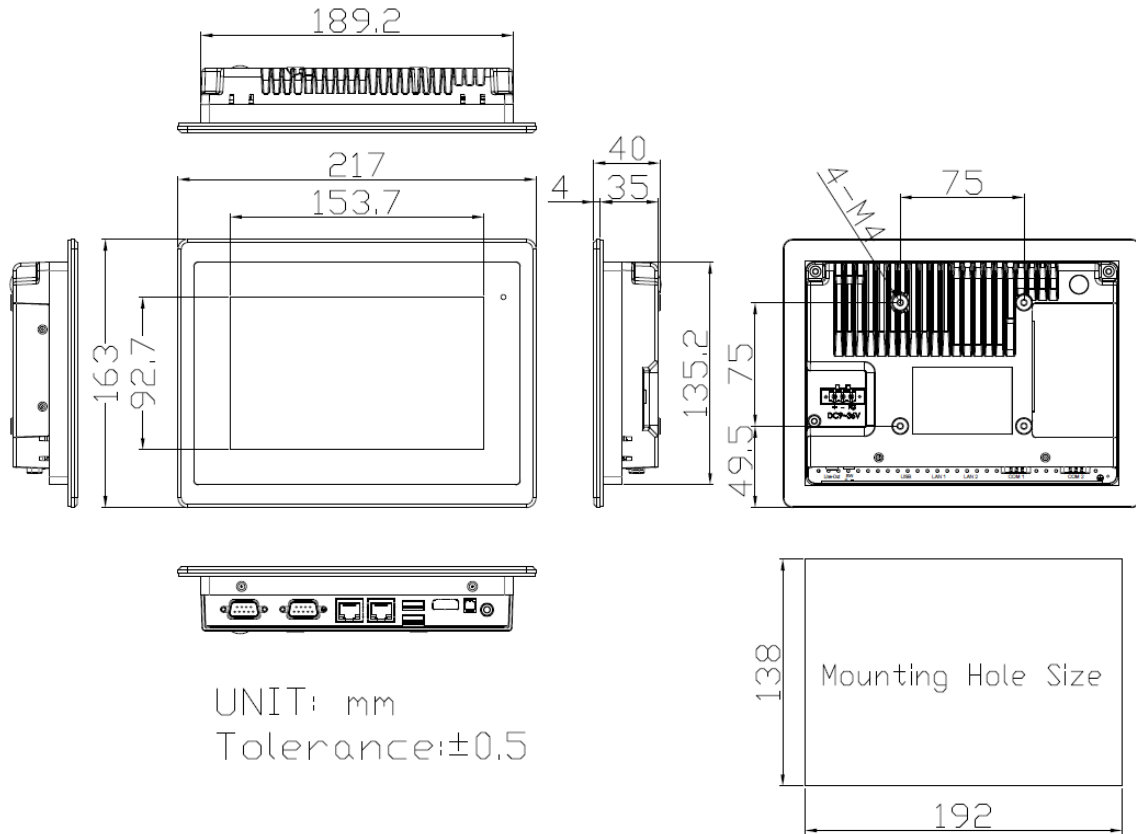

**Figure 1.1: Dimensions of FABS-807P/G(H)**

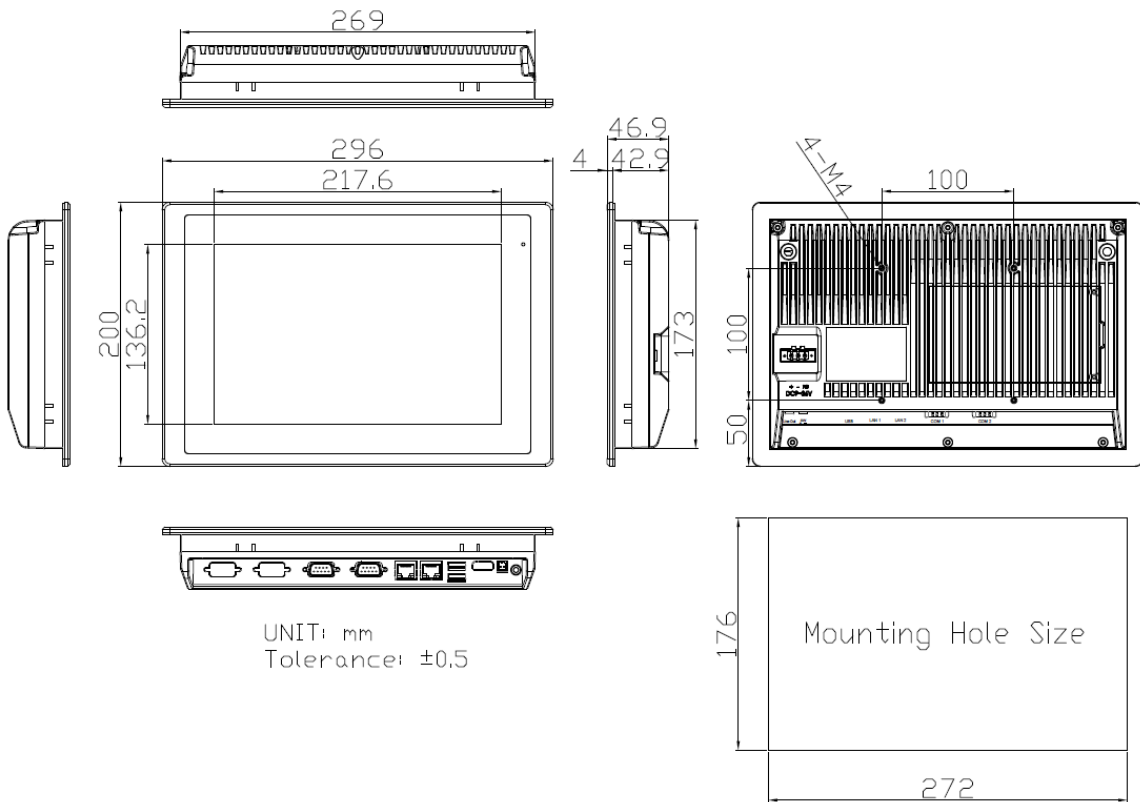

**Figure 1.2: Dimensions of FABS-810P/G(H)**

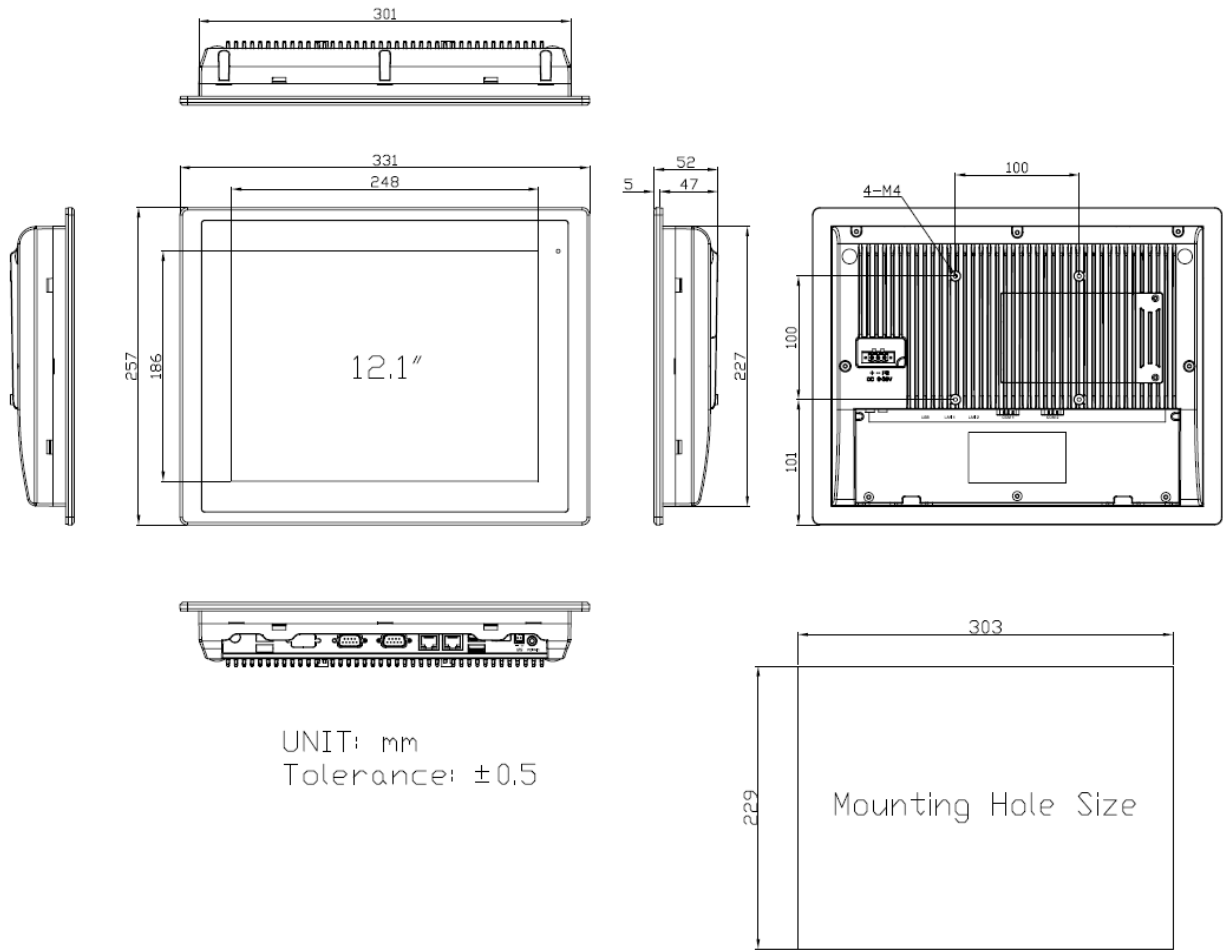

**Figure 1.3: Dimensions of FABS-812P/G(H)**

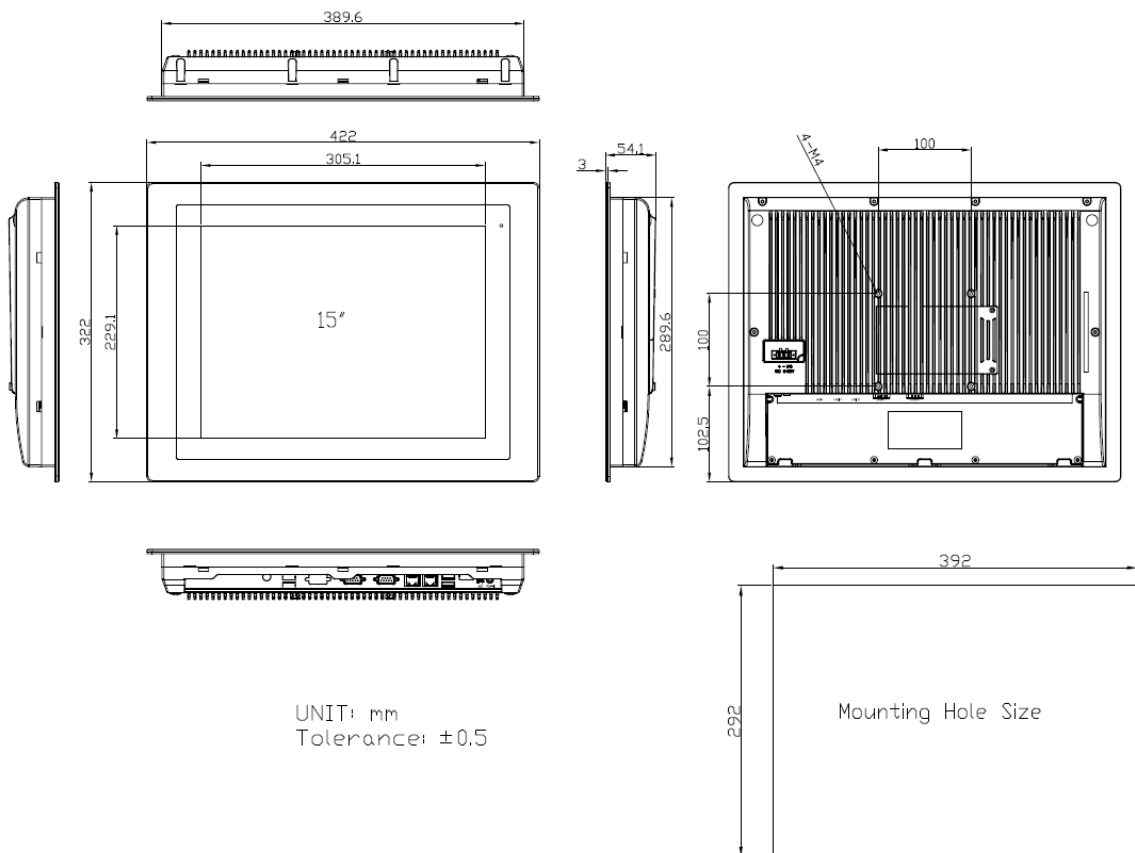

**Figure 1.4: Dimensions of FABS-815P/G(H)**

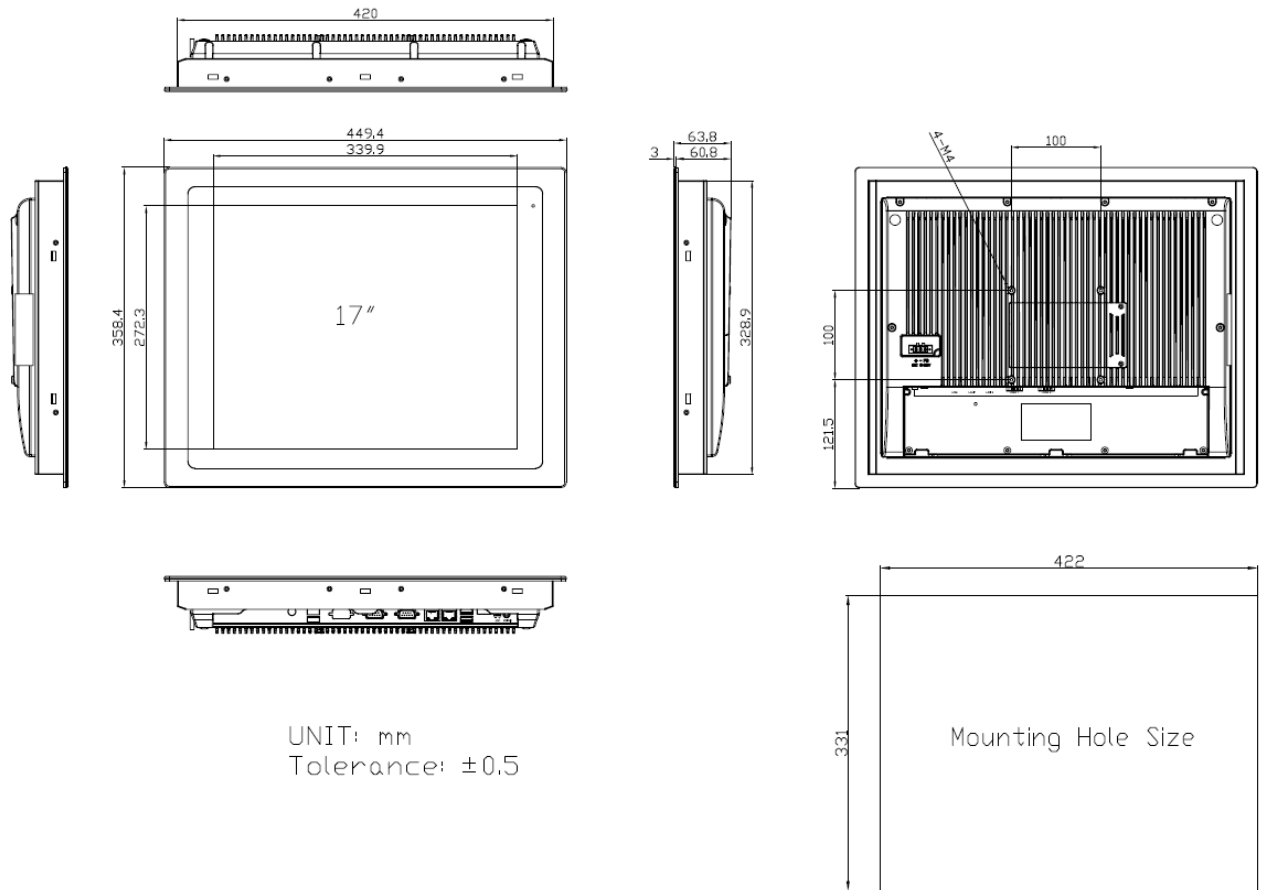

**Figure 1.5: Dimensions of FABS-817P/G(H)**

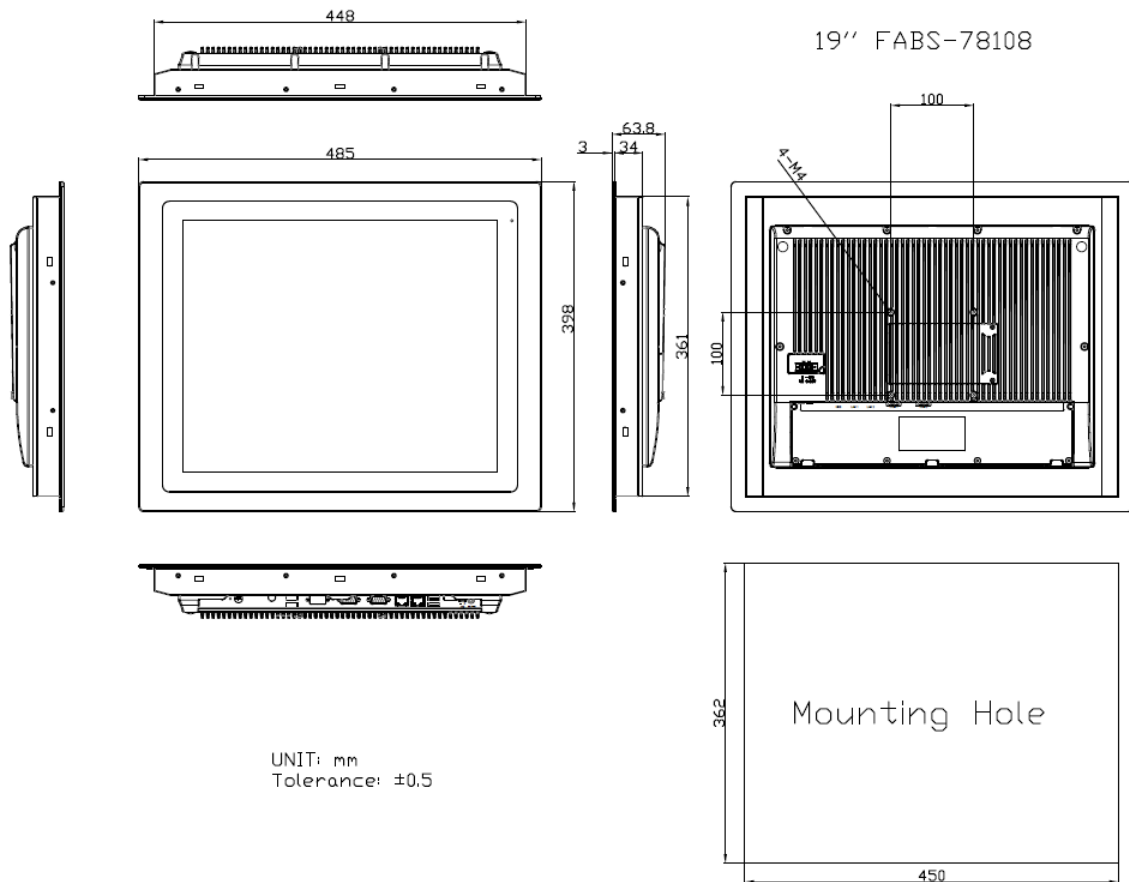

**Figure 1.6: Dimensions of FABS-819P/G(H)**

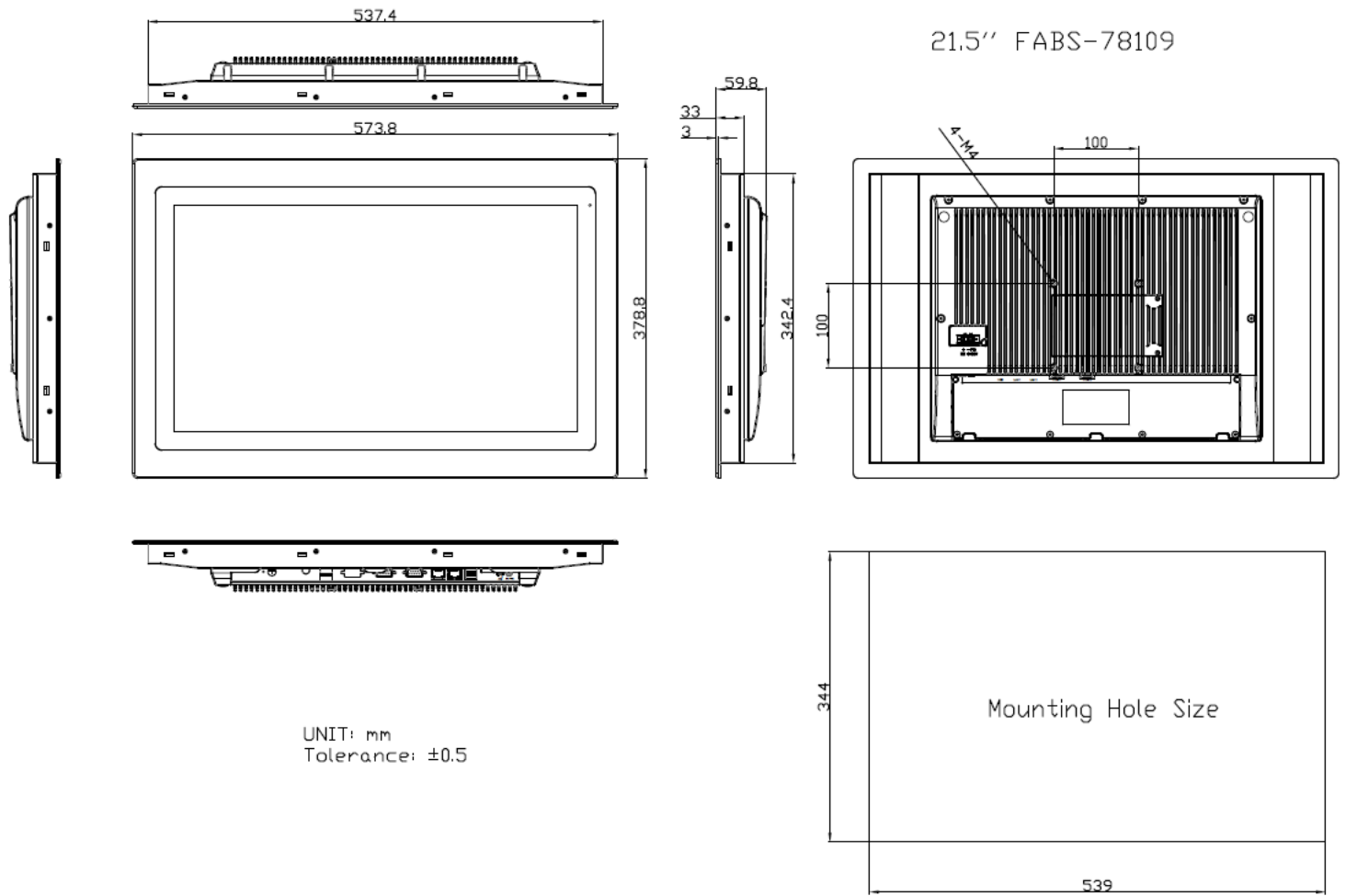

**Figure 1.7: Dimensions of FABS-821P/G(H)9**

## 1.4 Brief Description of FABS Series

FABS series are panel PC series models for food industrial application, which comes with Optimized frame designed. It is powered by Intel Celeron N2930 processor and supports 4GB DDR3L onboard memory. It comes with a 7"~21.5" color TFT display. There multiple I/O ports such as USB, LAN, and so on. This model are designed by minimize grooves and gaps as well as increased resistance to cleaning and disinfection agent and can be panel mount with control cabinet so that liquids can run off. The model supports wide range DC 9-36V power input and the front touch panel certified by IP66/69K degree, thus you can use it in food industrial environment and give the best in monitoring and control applications.



**Figure 1.8: Front View of FABS Series**



**Figure 1.9: Rear View of FABS Series**

## 2.1 Adjust your monitor and posture

There is no one monitor placement that can keep all body parts happy all the time. Throughout the day, let the comfort of your eyes, neck, shoulders, and back help you determine how to move and when. Placement, zoom, and lighting are all important factors that affect your comfort and productivity. We suggest following the guideline below, and adjusting your monitor and posture when you use our products:

- To find out your comfortable viewing distance, adjust the monitor height up and down until your head is balanced comfortably over your shoulders.
- Your head should not come forward as well as your neck should not bend uncomfortably forward, backward to any degree.
- Place the monitor in an area where glare and bright reflections are eliminated. Try to avoid bright light sources in your field of vision. Also you can adjust LCD backlight from [Chipset Setting] (please refer page 45) according light source environment.
- To avoid craning your neck forward to view the text that is too small, experiment with adjusting the percentage of zoom to 125 percent or higher.
- Remember to blink, on the average, people blink 22 times per minute. Without realize it, when viewing a monitor, some people slow their blink rate to less than 7 blinks per minute. Also suggest take 10 minutes breaks after you watch the screen 40~50 minutes every time.
- Our products support touch technology, when using touch, you need to be especially attentive to the comfort of your neck, shoulders, and arms. There is no one monitor placement can keep all body parts comfortable all the time, so you should adjust your screen when you feel uncomfortably.



Here is a demo posture when you use our products; please adjust your work surface so that your shoulders will be relaxed and keep your wrists neutrally aligned.

## 2.2 Panel mounting your monitor

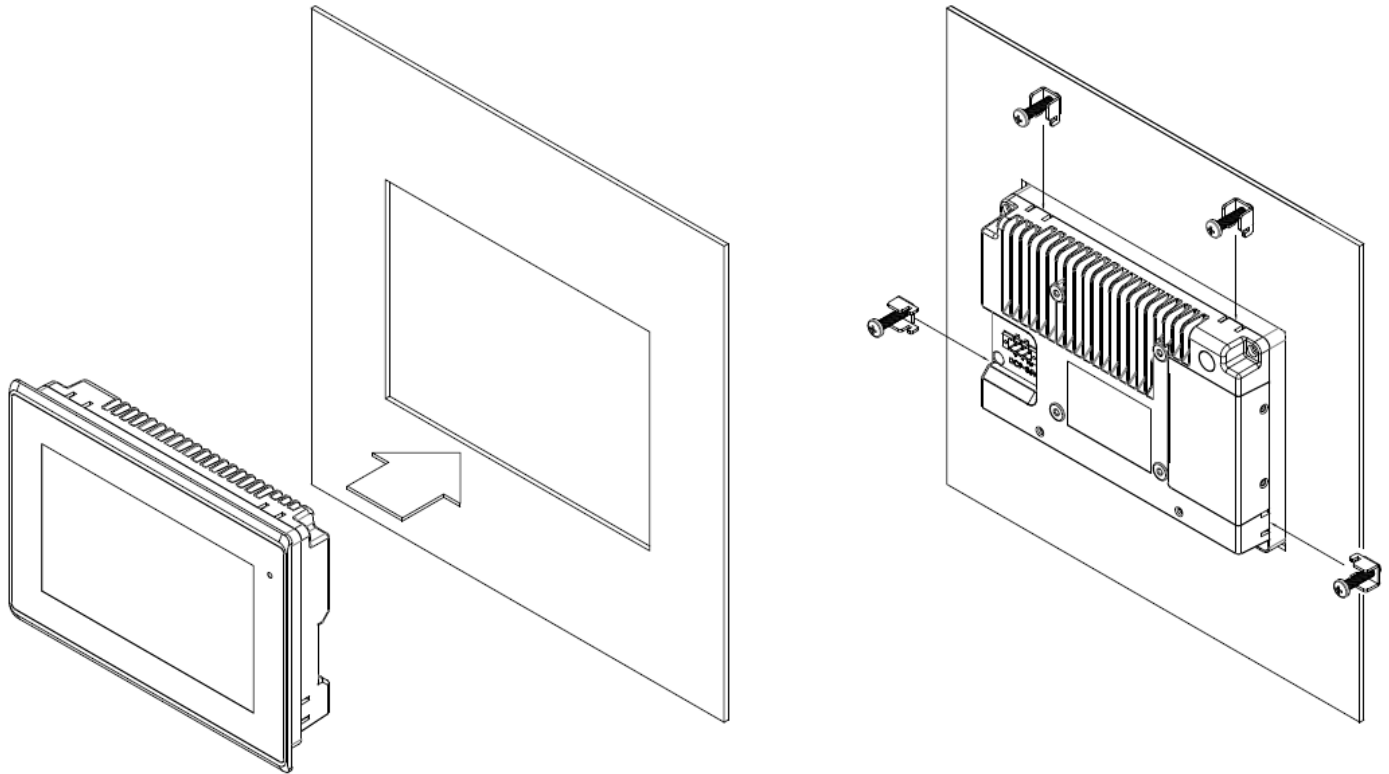

**Figure 1.10: Panel Mounting of FABS Series**



## 3.1 Motherboard Introduction

SBC-7111 is a 4" industrial motherboard developed on the basis of Intel Bay trail-I/M Processors, which provides abundant peripheral interfaces to meet the needs of different customers. Also, it features dual GbE ports, 4-COM ports and one Mini PCIE configuration, one VGA port, one HDMI port, one LVDS interface. To satisfy the special needs of high-end customers, CN1 and CN2 and CN3 richer extension functions. The product is widely used in various sectors of industrial control.

## 3.2 Specifications

Specifications	
<b>Board Size</b>	170mm x 113mm
<b>CPU Support</b>	Intel Atom E3845 /1.91GHz (4cores,10W, onboard) Intel Celeron N2930 /1.83 up to 2.16GHz (4cores,option )
<b>Chipset</b>	SOC
<b>Memory Support</b>	Onboard 2GB DDR3L SDRAM (N2930,option) Onboard 4GB DDR3L SDRAM (E3845/N2930,option) Onboard 8GB DDR3L SDRAM (N2930,option)
<b>Graphics</b>	Intel® HD Graphics 313/854MHz (N2930) Intel® HD Graphics 542/792MHz (E3845)
<b>Display Mode</b>	1 x HDMI Port 1 x LVDS (18/24-bit dual LVDS) 1 x CRT Port
<b>Support Resolution</b>	Up to 1920 x 1200 for HDMI Up to 1920 x 1200 for LVDS (PS8625) Up to 1920 x 1200 for CRT
<b>Dual Display</b>	HDMI + LVDS HDMI + CRT LVDS + CRT
<b>Super I/O</b>	ITE IT8518E Fintek F81216AD
<b>BIOS</b>	AMI/UEFI
<b>Storage</b>	1 x SATAII Connector (7Pin, option) 1 x SATAII Connector (7Pin+15Pin) 1 x SD Slot (USB2 to SD)

<b>Ethernet</b>	2 x PCIe Gbe LAN by Intel 82574L
<b>USB</b>	<p><b>USB 3.0 Hub ( USB5534 ) :</b>  2 x USB 3.0/USB2.0 (type A)stack ports (E2_USB5/E2_USB6)  1 x USB 2.0 for internal Touch controller (E2_USB7)  1 x USB 2.0 Pin header for CN1 (E2_USB8)</p> <p><b>USB 2.0 Hub ( USB2514 ) :</b>  1 x USB 2.0 Pin header for CN2 (E-USB9)  2 x USB 2.0 Pin header for CN3 (E-USB10/E-USB11)  1 x USB 2.0 for MPCIE1 (E-USB12)</p>
<b>Serial</b>	<p>1 x RS232/RS422/RS485 port, DB9 connector for external (COM1)  Pin 9 w/5V/12V/Ring select</p> <p>1 x RS232 port, DB9 connector for external (COM2)  Pin 9 w/5V/12V/Ring select</p> <p>2 x UART for CN3 (COM3,COM4)</p> <p><b>2 x RS422/485 header for CN2 (IT8518E/COM5/COM6)</b></p>
<b>Digital I/O</b>	<p>8-bit digital I/O by Pin header (CN2)  4-bit digital Input  4-bit digital Output</p> <p>4-bit digital I/O by Pin header (CN3)  2-bit digital Input  2-bit digital Output</p>
<b>Battery</b>	Support CR2477 Li battery by 2-pin header (BAT1/CMOS)
<b>Audio</b>	<p>Support Audio via Realtek ALC662-VD HD audio codec</p> <p>Support Line-in, Line-out, MIC by 2x6-pin header</p>
<b>Keyboard /Mouse</b>	1 x PS2 keyboard/mouse by box pin header (CN3)
<b>Expansion Bus</b>	<p>1 x mini-PCI-express slot</p> <p>1 x PCI-express (CN3)</p>
<b>Touch Ctrl</b>	1 x Touch ctrl header for TCH1 (PM6000 for USB4 or COM6)
<b>Power Management</b>	<p>Wide Range DC6V-36V input</p> <p>1 x 3-pin power input connector (DC_IN1/DC6-36V)</p> <p>1 x 4-pin power input connector (DC_IN2/DC12V)</p>
<b>Switches and LED Indicators</b>	<p>1 x Power on/off switch (BT1/BT2/P_SW/CN2/CN3)</p> <p>1 x Reset (CN2)</p> <p>1 x Power LED status (CN1)</p> <p>1 x HDD LED status (CN2)</p> <p>1 x Buzzer</p>

<b>External I/O port</b>	2 x COM Ports (COM1/COM2) 2 x USB 3.0/2.0 Ports (stack) 2 x RJ45 GbE LAN Ports 1 x HDMI Port 1 x Stack audio Jack (Line out) 1 x Power on/off switch (BT1)
<b>Temperature</b>	Operating: -20°C to 70°C Storage: -40°C to 85°C
<b>Humidity</b>	10% - 90%, non-condensing, operating
<b>Power Consumption</b>	<a href="#">12V /0.80A</a> (Intel Atom E3845 <a href="#">processor with 4GB DDR3L DRAM</a> ) <a href="#">12V /0.60A</a> (Intel Atom E3815 <a href="#">processor with 2GB DDR3L DRAM</a> ) <a href="#">12V /0.70A</a> (Intel Atom N2930 <a href="#">processor with 4GB DDR3L DRAM</a> )
<b>EMI/EMS</b>	Meet CE/FCC class A

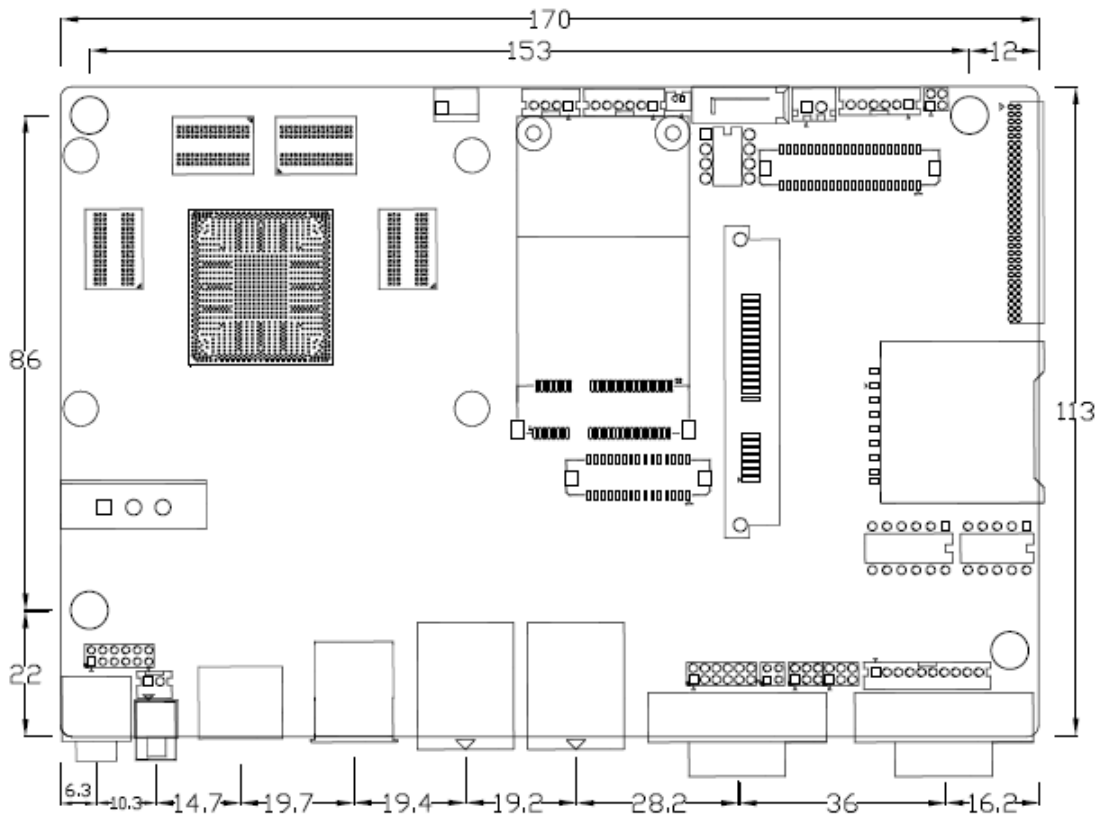

(units :mm)

**Figure 2.1: Motherboard Dimensions**

### 3.3 Jumpers and Connectors Location

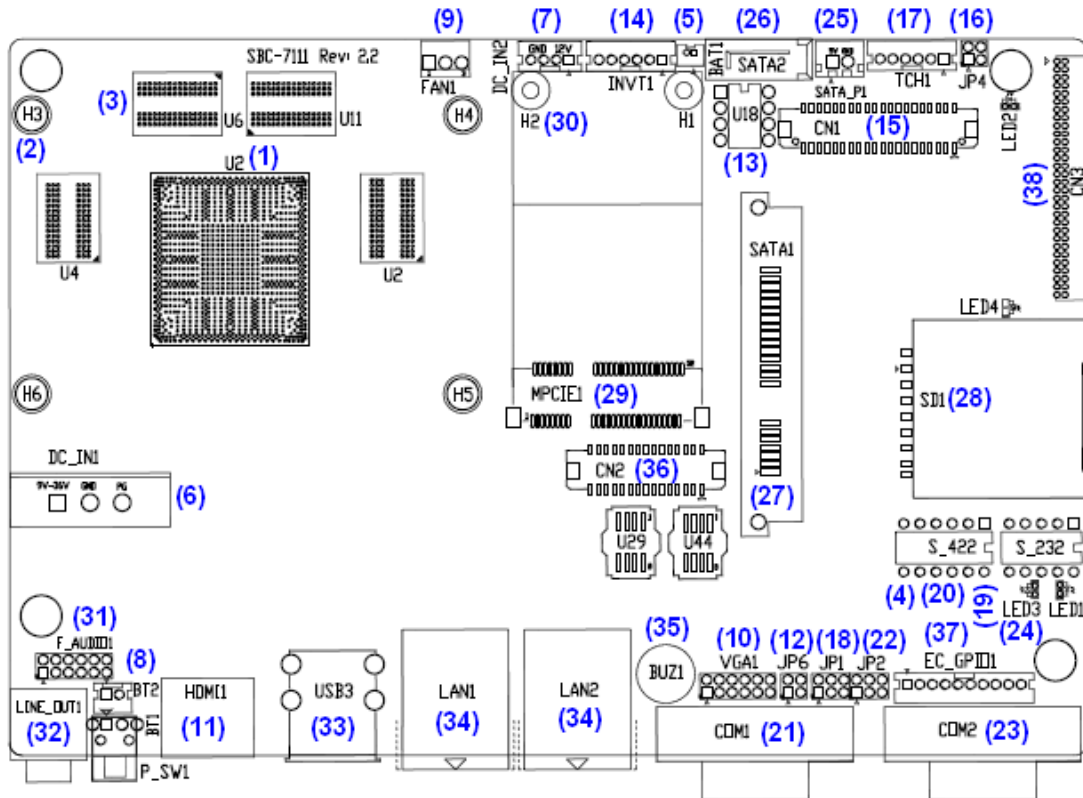

Figure 2.2: Jumpers and Connectors Location- Board Top

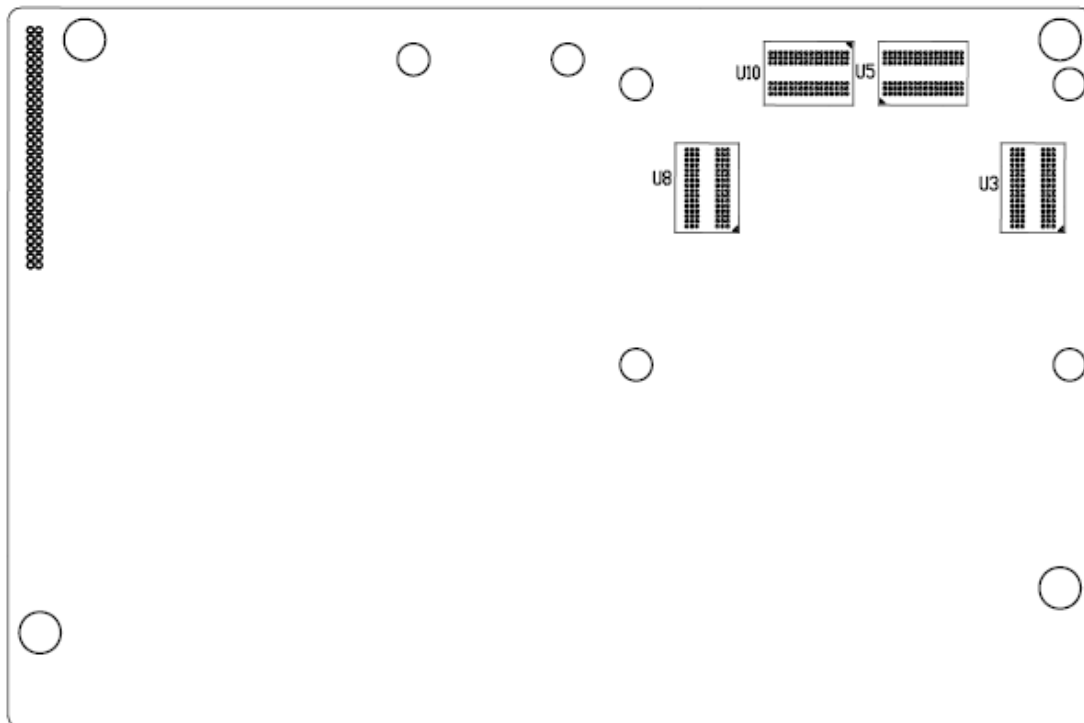

Figure 2.3: Jumpers and Connectors Location- Board Bottom

### 3.4 Jumpers Setting and Connectors

**1. U2:**

(FCBGA1170), onboard Intel Bay trail-I/M Processors.

Model	Processor				
	Number	PBF	Cores/ Threads	TDP	Remarks
SBC-7111-N2930-4G	N2930	1.83 up to 2.16GHz	4 / 4	4.5/ 7.5W	
<a href="#">SBC-7111-N2930-4G-SW</a>					
SBC-7111-N2930P-4G					
SBC-7111-N2930-2G					
<a href="#">SBC-7111-N2930P-CN3V-2G</a>					
<a href="#">SBC-7111-N2930-8G</a>					
SBC-7111-E3845-4G	E3845	1.91GHz	4 / 4	10W	option

**2. H3/H4/H5/H6(option):**

U2 Heat Sink Screw holes, four screw holes for intel Bay trail-I/M Processors  
Heat Sink assemble.

**3. U3/U4/U5/U6:**

(FBGA96)Onboard DDR3L Memory.

Model	Memory
SBC-7111-N2930-4G	4GB
SBC-7111-N2930-4G-SW	4GB ( option )
SBC-7111-N2930P-4G	4GB ( option )
SBC-7111-E3845-4G	4GB ( option )
SBC-7111-N2930-2G	2GB ( option )
<a href="#">SBC-7111-N2930P-CN3V-2G</a>	<a href="#">2GB ( option )</a>
SBC-7111-N2930-8G	8GB ( option )

**4. S-422 (PIN6):**

(Switch),ATX Power and Auto Power on jumper setting.

S-422(Switch)	Mode
Pin6 ( Off )	ATX Power
Pin6 ( On )	<b>Auto Power on (Default)</b>

**5. BAT1 :**

(1.25mm Pitch 1x2 Wafer Pin Header) 3.0V Li battery is embedded to provide power for CMOS.

Pin#	Signal Name
Pin1	VBAT
PIN2	Ground

**6. DC IN1:**

(5.08mm Pitch 1x3 Pin Connector),DC9V~36V System power input connector.

Pin#	Power Input
Pin1	DC+6V-36V ( R2.1 : 9~36V )
Pin2	Ground
Pin3	FG

Model	DC_IN1
SBC-7111-N2930-4G	180°Connector
SBC-7111-N2930-4G-SW	180°Connector
SBC-7111-N2930-2G	180°Connector
SBC-7111-N2930-8G	180°Connector
SBC-7111-E3845-4G	180°Connector
SBC-7111-N2930P-4G	45°Connector
SBC-7111-N2930P-CN3V-2G	45°Connector

**7. DC IN2 ( option ) :**

(2.0mm Pitch 1x8 Wafer Pin Header), DC12V System power input connector.

Pin#	Signal Name
Pin1	VCC_BAT (DC+12V input)
Pin2	VCC_BAT (DC+12V input)
Pin3	Ground
Pin4	Ground

**8. BT1/BT2/P SW (option) :**

**Power on/off button**, They are used to connect power switch button. The two pins are disconnected under normal condition. You may short them temporarily to realize system startup & shutdown or awaken the system from sleep state.

Model	BT1	BT2	P_SW1
SBC-7111-N2930-4G	●	●	○
SBC-7111-N2930P-4G	●	●	○
SBC-7111-N2930-2G	●	●	○
SBC-7111-N2930-8G	●	●	○
SBC-7111-E3845-4G	●	●	○
SBC-7111-N2930P-CN3V-2G	○	●	○
SBC-7111-N2930-4G-SW	○	●	●

**9. FAN1(option):**

(2.54mm Pitch 1x3 Pin Header), Fan connector, cooling fans can be connected directly for use. You may set the rotation condition of cooling fan in menu of BIOS CMOS Setup.



Pin#	Signal Name
1	Ground
2	VCC
3	Rotation detection



Note:

Output power of cooling fan must be limited under 5W.

Model	FAN1
SBC-7111-N2930-4G	○
SBC-7111-N2930-4G-SW	○
SBC-7111-N2930P-4G	○
SBC-7111-N2930P-CN3V-2G	○
SBC-7111-E3845-4G	○
SBC-7111-N2930-2G	○
SBC-7111-N2930-8G	○

**10. VGA1:**

(CRT 2.0mm Pitch 2x6 Pin Header), Video Graphic Array Port, Provide 2x6Pin cable to VGA Port.

Signal Name	Pin#	Pin#	Signal Name
CRT_RED	1	2	Ground
CRT_GREEN	3	4	Ground
CRT_BLUE	5	6	VGA_EN
CRT_H_SYNC	7	8	CRT_DDCDATA
CRT_V_SYNC	9	10	CRT_DDCCLK
Ground	11	12	Ground

VGA hot plug setting	
VGA1 ( Pin Header )	Function
Pin4-Pin6 ( Close )	VGA Simulation Disabled
Pin4-Pin6 ( Open )	VGA Simulation Enabled
use the 2.0mm jumper cap to close pin 4 and pin6	

**11. HDMI1:**

(HDMI 19P Connector), High Definition Multimedia Interface connector.

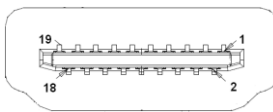

**12. JP6:**

(2.0mm Pitch 2x2 Pin Header),LVDS jumper setting.

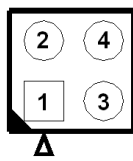

JP6	Function (CN1)
Pin1-Pin2 ( Close )	Single channel LVDS
<b>Pin1-Pin2 ( Open )</b>	<b>Dual channel LVDS (Default)</b>
<b>Pin3-Pin4 ( Close )</b>	<b>8/24 bit (Default)</b>
Pin3-Pin4 ( Open )	6/18 bit



**13. U18:**

AT24C02-DIP8,The EEPROM IC ( U18 ) is the set of LVDS resolution.

If you need other resolution settings, please upgrade U18 data.

Model	LVDS resolution
SBC-7111-N2930-4G	1280*1024 (Default)
SBC-7111-N2930-4G-SW	800*480 ( option )
SBC-7111-N2930P-4G	800*600 ( option )
SBC-7111-N2930P-CN3V-2G	1024*768 ( option )
SBC-7111-N2930-2G	1920*1080 ( option )
SBC-7111-N2930-8G	
SBC-7111-E3845-4G	.....

**14. INVT1:**

(2.0mm Pitch 1x6 wafer Pin Header), Backlight control connector for LVDS.

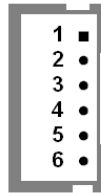

Pin#	Signal Name
1	+DC12V
2	+DC12V
3	Ground
4	Ground
5	BKLT_EN_OUT
6	BKLT_CTRL

**15. CN1 :**

(1.25mm Pitch 2x20 Connector,DF13-40P),For 18/24-bit LVDS output connector,Fully supported by Parad PS8625(DP to LVDS), the interface features dual channel 24-bit output. Low Voltage Differential Signaling, A high speed, low power data transmission standard used for display connections to LCD panels.

Function	Signal Name	Pin#		Signal Name	Function
	12V_S0	2	1	12V_S0	
	BKLT_EN_OUT	4	3	BKLT_CTRL	
	Ground	6	5	Ground	
	LVDS_VDD5	8	7	LVDS_VDD5	

LVDS	LVDS_VDD3	10	9	LVDS_VDD3	LVDS
	Ground	12	11	Ground	
	LA_D0_P	14	13	LA_D0_N	
	LA_D1_P	16	15	LA_D1_N	
	LA_D2_P	18	17	LA_D2_N	
	LA_D3_P	20	19	LA_D3_N	
	LA_CLKP	22	21	LA_CLKN	
	LB_D0_P	24	23	LB_D0_N	
	LB_D1_P	26	25	LB_D1_N	
	LB_D2_P	28	27	LB_D2_N	
	LB_D3_P	30	29	LB_D3_N	
	LB_CLKP	32	31	LB_CLKN	
	Ground	34	33	Ground	E2-USB8
E2-USB8	E2-USB8_P	36	35	E2-USB8_N	
	5V_S5_USB	38	37	5V_S5_USB	
Power LED	PWR_LED+	40	39	Ground	Power LED

**16. JP4 (Reserve) :**

(2.0mm Pitch 2x2 Pin Header).

JP4	Function
Open 3-4(default)	-
Open 1-2(default)	-
Close 3-4(option)	Hardware Enabled

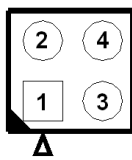

**17. TCH1:**

(2.0mm Pitch 1x6 wafer Pin Header), internal Touch controller connector.

Pin#	Signal Name
1	SENSE
2	X+
3	X-
4	Y+
5	Y-
6	GND_EARCH

Touch Interface setting	EC(U44) Data
<b>TCH1(PM6000)</b>	option A
CN1(E2-USB8)	option B

**18. JP1:**

\_\_\_\_(2.0mm Pitch 2x3 Pin Header),COM1 jumper setting, pin 1~6 are used to select signal out of pin 9 of COM1 port.

JP1 Pin#	Function
<b>Close 1-2</b>	<b>COM1 RI (Ring Indicator) (default)</b>
Close 3-4	COM1 Pin9:DC+5V (option)
Close 5-6	COM1 Pin9:DC+12V (option)

**19. S 232:**

\_\_\_\_(Switch),COM1 jumper setting, it provides selectable RS232 or RS422 or RS485 serial signal output.

Function	S_232 Pin# ( switch )
<b>RS232 (Default)</b>	<b>ON: Pin1, Pin2, Pin3, Pin4,Pin5</b>
RS422 (option)	OFF: Pin1, Pin2, Pin3, Pin4,Pin5
RS485 (option)	OFF: Pin1, Pin2, Pin3, Pin4,Pin5

**20. S 422:**

\_\_\_\_(Switch),COM1 setting, it provides selectable RS232 or RS422 or RS485 serial signal output.

Function	S_422 Pin# ( switch )
<b>RS232 (Default)</b>	<b>OFF: Pin1, Pin2, Pin3, Pin4, Pin5</b>
RS422 (option)	ON: Pin1, Pin2, Pin3, Pin4, Pin5
RS485 (option)	ON: Pin1, Pin2, Pin3, Pin4, Pin5

S-422 ( switch )	Mode
Pin6 ( Off )	ATX Power
Pin6 ( On )	<b>Auto Power on (Default)</b>

**21. COM1:**

**(Type DB9M)**, Rear serial port, standard DB9 Male serial port is provided to make a direct connection to serial devices. COM1 port is controlled by pins No.1~6 of JP1, select output Signal RI or 5V or 12V, For details, please refer to description of JP1 and S\_232 and S\_422 setting.

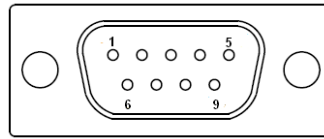

<b>RS232 (Default):</b>	
Pin#	Signal Name
1	DCD# (Data Carrier Detect)
2	RXD (Received Data)
3	TXD (Transmit Data)
4	DTR (Data Terminal Ready)
5	Ground
6	DSR (Data Set Ready)
7	RTS (Request To Send)
8	CTS (Clear To Send)
9	<b>JP1 select Setting (RI/5V/12V)</b>
BIOS Setup : Advanced/F81216SEC Super IO Configuration/Serial Port 1 Configuration <b>【RS-232】</b>	

<b>RS422 (option):</b>	
Pin#	Signal Name
1	422_RX+
2	422_RX-
3	422_TX-
4	422_TX+
5	Ground
6	NC
7	NC
8	NC
9	NC
BIOS Setup : Advanced/F81216SEC Super IO Configuration/Serial Port 1 Configuration <b>【RS-422】</b>	

RS485 (option):	
Pin#	Signal Name
1	NC
2	NC
3	485-
4	485+
5	Ground
6	NC
7	NC
8	NC
9	NC
BIOS Setup : Advanced/F81216SEC Super IO Configuration/Serial Port 1 Configuration 【RS-485】	

**22. JP2:**

\_\_\_\_(2.0mm Pitch 2x3 Pin Header),COM2 jumper setting, pin 1~6 are used to select signal out of pin 9 of COM2 port.

JP2 Pin#	Function
<b>Close 1-2</b>	<b>COM2 RI (Ring Indicator) (default)</b>
Close 3-4	COM2 Pin9 : DC+5V (option)
Close 5-6	COM2 Pin9 : DC+12V (option)

**23. COM2:**

**(Type DB9M)**,Rear serial port, standard DB9 Male serial port is provided to make a direct connection to serial devices.

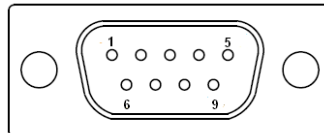

Pin#	Signal Name
1	DCD# (Data Carrier Detect)
2	RXD (Received Data)
3	TXD (Transmit Data)
4	DTR (Data Terminal Ready)
5	Ground
6	DSR (Data Set Ready)
7	RTS (Request To Send)
8	CTS (Clear To Send)
9	<b>JP2 select Setting (RI/5V/12V)</b>

**24. LED1,LED2,LED3,LED4 (option):**

LED1: LED STATUS. Green LED for Motherboard Power Good status.

LED2: LED STATUS. Green LED for Touch Power status.

LED3: LED STATUS. Green LED for EC Power status.

LED4: LED STATUS. Green LED for Motherboard Power Good status.

**25. SATA P(option):**

(2.5mm Pitch 1x2 box Pin Header), One onboard 5V output connector are reserved to provide power for SATA devices.

Pin#	Signal Name
1	+DC5V
2	Ground



**Note:**

**Output current of the connector must not be above 1A.**

Model	SATA_P (Wafer)
SBC-7111-N2930-4G	○
SBC-7111-N2930-4G-SW	○
SBC-7111-N2930P-4G	○
SBC-7111-N2930P-CN3V-2G	○
SBC-7111-E3845-4G	○
SBC-7111-N2930-2G	○
SBC-7111-N2930-8G	○

**26. SATA2(option):**

(SATA 7Pin), SATA Connectors, one SATA connector are provided, with transfer speed up to 3.0Gb/s.

Model	SATA2 (Connectors)
SBC-7111-N2930-4G	○
SBC-7111-N2930-4G-SW	○
SBC-7111-N2930P-4G	○
SBC-7111-N2930P-CN3V-2G	○
SBC-7111-E3845-4G	○
SBC-7111-N2930-2G	○
SBC-7111-N2930-8G	○

**27. SATA1:**

(SATA 7Pin+15Pin), SATA Connectors, one SATA connector are provided, with transfer speed up to 3.0Gb/s.

**28. SD1:**

(SD card slot),Secure Digital Memory Card socket.

**29. MPCIE1:**

(Socket 52Pin),mini PCIe socket, it is located at the top, it supports mini PCIe devices with USB2.0 and LPC and SMBUS and PCIe signal. MPCie card size is 30x50.95mm.

**30. H1/H2:**

MPCIE1 SCREW HOLES, H1and H2 for mini PCIe card (30mmx50.95mm) assemble.

**31. F AUDIO1:**

(2.0mm Pitch 2x6 Pin Header), Front Audio, An onboard Realtek ALC662-VD codec is used to provide high-quality audio I/O ports. Line Out can be connected to a headphone or amplifier. Line In is used for the connection of external audio source via a Line in cable. MIC is the port for microphone input audio.

Signal Name	Pin#	Pin#	Signal Name
+5V	1	2	GND_AUD
LINE-OUT-L	3	4	LINE-OUT-R
FRONT_JD	5	6	LINE1_JD
LINE-IN-L	7	8	LINE-IN-R
MIC-IN-L	9	10	MIC-IN-R
GND_AUD	11	12	MIC1_JD

**32. LINE OUT1:**

(Diameter 3.5mm Jack), HD Audio port, An onboard Realtek ALC662-VD codec is used to provide high quality audio I/O ports. Line Out can be connected to a headphone or amplifier.

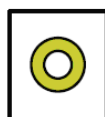

Line out

Model	LINE_OUT1
SBC-7111-N2930-4G	●
SBC-7111-N2930P-4G	●

SBC-7111-N2930-2G	●
SBC-7111-N2930-8G	●
SBC-7111-E3845-4G	●
SBC-7111-N2930P-CN3V-2G	○
SBC-7111-N2930-4G-SW	●

### 33. **USB3:**

**USB0/USB3 :** (Double stack USB type A), Rear USB connector, it provides up to two USB3.0 port,one USB2.0 port, support USB full-speed and low-speed signaling.

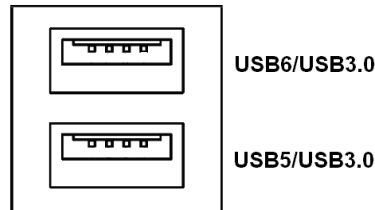

Each USB Type A Receptacle (2 Ports) Current limited value is **2.0A**.

If the external USB device current exceeds 2.0A, please separate connectors into different Receptacle.

### 34. **LAN1/LAN2:**

**LAN1/LAN2:** (RJ45 Connector), Rear LAN port, Two standard 10/100/1000M RJ-45 Ethernet ports are provided. Used intel 82574L chipset, LINK LED (green) and ACTIVE LED (yellow) respectively located at the left-hand and right-hand side of the Ethernet port indicate the activity and transmission state of LAN.

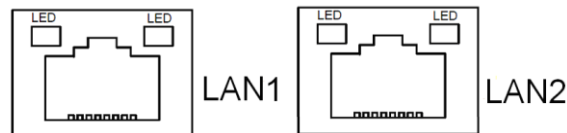

Model	RJ45(LAN1)	RJ45(LAN2)
SBC-7111-N2930-4G	●	●
SBC-7111-N2930P-4G	●	●
SBC-7111-N2930-2G	●	●
SBC-7111-N2930-8G	●	●
SBC-7111-E3845-4G	●	●
SBC-7111-N2930P-CN3V-2G	●	○
SBC-7111-N2930-4G-SW	●	●

### 35. **BUZ1:**

Onboard buzzer.



### 36. CN2:

(DF13-30P Connector),For expand output connector, It provides eight GPIO,one RS422 or RS485,one USB2.0,one Power on/off, one Reset.

Function	Signal Name	Pin#		Signal Name	Function
5V	5V_S5	2	1	5V_S5	5V
SOC_GPIO10	GPIO_IN2	4	3	GPIO_IN1	SOC_GPIO09
SOC_GPIO26	GPIO_IN4	6	5	GPIO_IN3	SOC_GPIO17
SOC_GPIO05	GPIO_OUT2	8	7	GPIO_OUT1	SOC_GPIO04
SOC_GPIO08	GPIO_OUT4	10	9	GPIO_OUT3	SOC_GPIO06
	Ground	12	11	Ground	
485 or 422	485+_422TX5+	14	13	485-_422TX5-	485 or 422
RS422 (COM5)	422_RX5+	16	15	422_RX5-	RS422(COM5)
485 or 422	485+_422TX6+	18	17	485-_422TX6-	485 or 422
RS422(COM6)	422_RX6+	20	19	422_RX6-	RS422(COM6)
5V	5V_S0	22	21	HDD_LED+	HDD LED
USB2.0	5V_USB09	24	23	5V_USB09	USB2.0
	E_USB9_P	26	25	E_USB9_N	
	Ground	28	27	FP_RST-	RESET
Power auto on	PWRBTN_ON	30	29	Ground	
COM5/COM6 BIOS Setup :					
Advanced/IT8518Super IO Configuration/Serial Port 1 Configuration 【RS-485】					
Advanced/IT8518Super IO Configuration/Serial Port 1 Configuration 【RS-422】					
Advanced/IT8518Super IO Configuration/Serial Port 2 Configuration 【RS-485】					
Advanced/IT8518Super IO Configuration/Serial Port 2 Configuration 【RS-422】					

### 37. EC GPIO1(option):

(2.0mm Pitch 1X10 Pin Header),For expand connector, It provides eight GPIO.

Pin#	Signal Name
1	Ground
2	GPA0_ONOFF
3	GPA1_SPK-
4	GPE6_BKLT-
5	GPE0_BKLT+
6	GPC3_SPK+
7	BKLT_CTRL_PWR
8	ADC6_BKLT_CTRL
9	ADC7_L_SENSE

10	3.3V
----	------

Function	EC_GPIO1
Backlight Automatic dimming	○
Backlight manual dimming	○

**38. CN3:**

(1.27mm Pitch 2X30 Female Header),For expand output connector,It provides four GPIO,two USB 2.0,one PS/2 mouse,one PS/2 keyboard, two uart,one PCIe1,one SMBus. connected to the TB-528 riser Card.

Function	Signal Name	Pin#		Signal Name	Function
	5V_S5_USB	1	2	5V_S5_USB	
	5V_S5_USB	3	4	5V_S5_USB	
	USB1011_OC	5	6	PSON_ATX-	
Exp-USB10	E-USB10_N	7	8	E-USB10_P	Exp-USB10
Exp-USB11	E-USB11_N	9	10	E-USB11_P	Exp-USB11
	Ground	11	12	Ground	
PS/2 MS	PS2_MSCLK	13	14	PS2_MSDATA	PS/2 MS
PS/2 KB	PS2_KBCLK	15	16	PS2_KBDATA	PS/2 KB
COM4 (UART)	COM4_RI	17	18	COM4_DCD-	COM4 (UART)
	COM4_TXD	19	20	COM4_RXD	
	COM4_DTR	21	22	RICOM4_RTS-	
	COM4_DSR	23	24	COM4_CTS-	
	Ground	25	26	Ground	
COM3 (UART)	COM3_RI	27	28	COM3_DCD-	COM3 (UART)
	COM3_TXD	29	30	COM3_RXD	
	COM3_DTR	31	32	DSRCOM3_RTS-	
	COM3_DSR	33	34	DTRCOM3_CTS-	
GPIO23	SOC_GPIO23	35	36	SOC_GPIO22	GPIO22
GPIO25	SOC_GPIO25	37	38	SOC_GPIO24	GPIO24
	Ground	39	40	Ground	
PCIe 1X	PCIE_TX0_DN	41	42	PCIE_TX0_DP	PCIe 1X
	PCIE_RX0_DN	43	44	PCIE_RX0_DP	
	Ground	45	46	Ground	
	PCIE_REFCLK0_DN	47	48	PCIE_REFCLK0_DP	
	PCIE0_WAKE_N	49	50	PLTRST_OUT-	

SMBUS	SMB_CLK_S0	51	52	SMB_DATA_S 0	SMBUS
PCIE	PCIE_CLKREQ0 _N	53	54	Ground	
	3P3V_S5	55	56	PWRBTN_ON-	Power Auto on
	3P3V_S5	57	58	3P3V_S5	
12V	12V_S0	59	60	12V_S0	12V

Model	CN3(connector)
SBC-7111-N2930-4G	90°Connector
SBC-7111-N2930-4G-SW	90°Connector
SBC-7111-N2930-2G	90°Connector
SBC-7111-N2930-8G	90°Connector
SBC-7111-E3845-4G	90°Connector
SBC-7111-N2930P-4G	90°Connector
SBC-7111-N2930P-CN3V-2G	180°Connector

## 4.1 Operations after POST Screen

After CMOS discharge or BIOS flashing operation, press [Delete] key to enter CMOS Setup.



After optimizing and exiting CMOS Setup

## 4.2 BIOS Setup Utility

Press [Delete] key to enter BIOS Setup utility during POST, and then a main menu containing system summary information will appear.

## 4.3 Main Settings

Aptio Setup Utility – Copyright (C) 2016 American Megatrends, Inc.					
Main	Advanced	Chipset	Security	Boot	Save & Exit
BIOS Information		Choose the system default			
BIOS Vendor	American Megatrends		Language		
Core Version	5.010		←		
Compliance	UEFI 2.4; PI 1.3		←		
Project Version	7111I 4.07 x64		←		
Build Date and Time	03/03/2016 15:18:10		←		
CPU Configuration		←			
Microcode Patch	901		←		
BayTrail SoC	DO Stepping		←		
KSC Information		←			
KSC Version	N/A		←		
Memory Information		←			
Total Memory	4096 MB (DDR3L)		←		
GOP Information		←			
Intel (R) GOP Driver	[N/A]		←		
TXE Information		←			
Sec RC Version	00.05.00.00		←		
TXE FW Version	01.01.00.1089		←		
System Language	[English]		←		
System Date	[Sun 01/01/2012]		←		
System Time	[00:00:10]		←		
		→←: Select Screen ↑↓ : Select Item Enter: Select +/=: Charge Opt. F1 : General Help F2: Previous Values F3:Optimized Defaults F4:Save and Exit ESC Exit			
Version 2.17.1246. Copyright (C) 2016 American Megatrends , Inc.					

### System Time:

Set the system time, the time format is:

Hour : 0 to 23

Minute : 0 to 59

Second : 0 to 59

### System Date:

Set the system date, the date format is:

**Day:** Note that the 'Day' automatically changes when you set the date.  
**Month:** 01 to 12  
**Date:** 01 to 31  
**Year:** 1998 to 2099

## 4.4 Advanced Settings

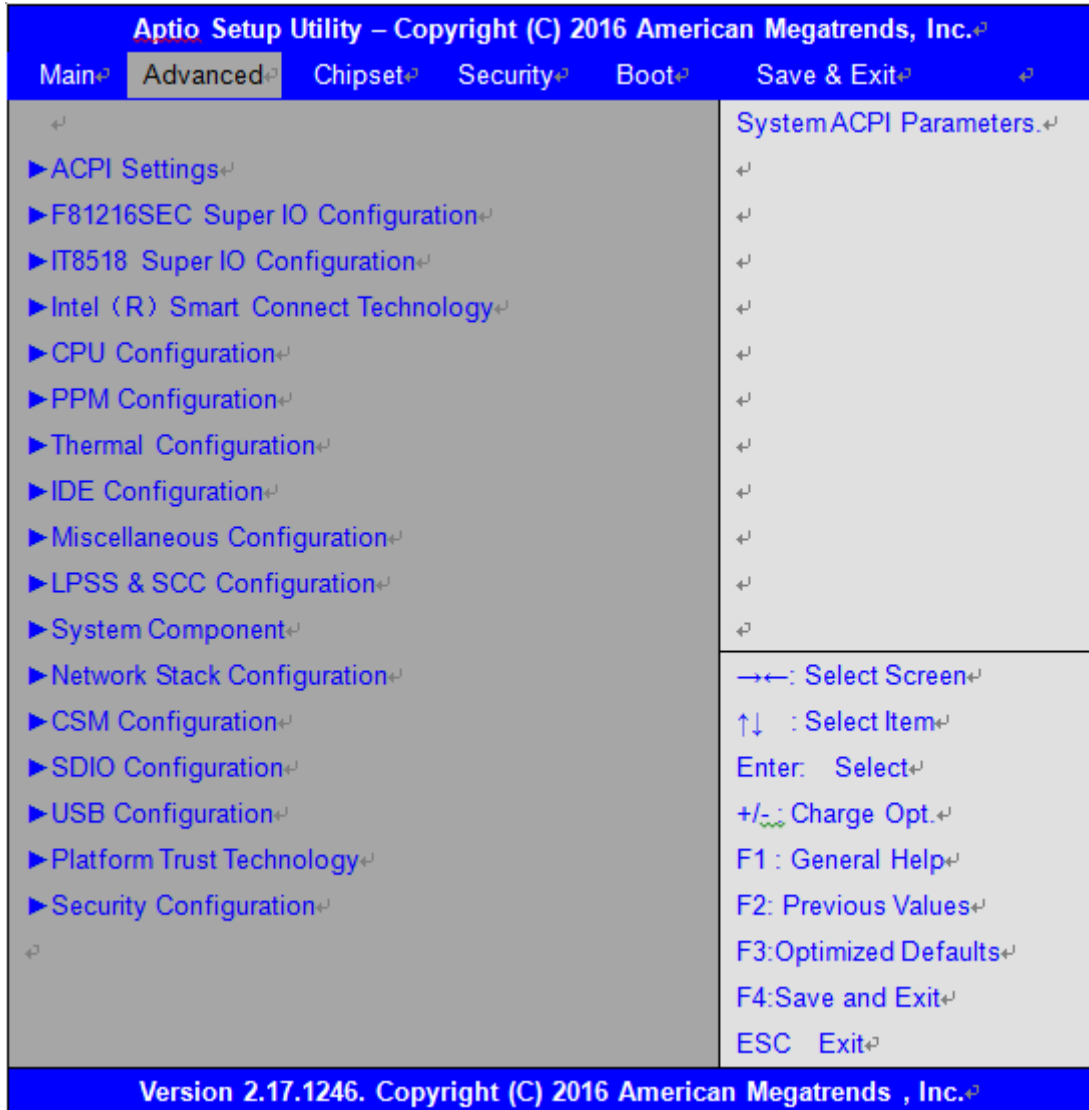

### 4.4.1 ACPI Settings

**Enable ACPI Auto Conf:**

**[Disabled]**

**[Enabled]**

**Enable Hibernation:**

**[Enabled]**

**[Disabled]**

## ACPI Sleep State:

**[S3 (Suspend to RAM) ]**

[Suspend Disabled]

## Lock Legacy Resources:

**[Disabled]**

[Enabled]

### 4.4.2 F81216SEC Super IO Configuration

Super IO chip F81216SEC

Serial Port 1 Configuration

UART1 Mode Selection:

**[RS-232]**

[RS-485]

[RS-422]

Serial Port 2 Configuration

Change Settings [Auto]

Serial Port 3 Configuration

Change Settings [Auto]

Serial Port 4 Configuration

Change Settings [Auto]

### 4.4.3 IT8518 Super IO Configuration

Super IO chip IT8518/IT8519

Serial Port 1 Configuration

Backlight PWM Controller (COM5) :

**[RS-485]**

[RS-422]

Serial Port 2 Configuration (COM6)

Change Settings [Auto]

**[RS-485]**

[RS-422]

### 4.4.4 Intel (R) Smart Connect Technology

ISCT Support

[Disabled]

[Enabled]

#### 4.4.5 CPU Configuration

##### Socket 0 CPU Information

Intel(R) Atom(TM) CPU E3845 @ 1.91GHz

CPU Signature 30679

Microcode Patch 901

Max CPU Speed 1910 MHz

Mix CPU Speed 500MHz

Processor Cores 4

Intel HT Technology Not Supported

Intel HT-X Technology Supported

L1 Data Cache 24KB x 4

L1 Code Cache 32KB x 4

L2 Cache 1024 KB x 2

L2 Cache Not Present

CPU Thermal configuration

CPU Speed 1918 MHz

64-bit Supported

Hyper-Threading:

**[Enabled]**

[Disabled]

Limit CPUID Maximum:

**[Disabled]**

[Enabled]

Execute Disable Bit:

**[Enabled]**

[Disabled]

Intel Virtualization Technology:

**[Enabled]**

[Disabled]

Power Technology

**[Energy Efficient]**

[Disabled]

[Custom]



#### 4.4.6 PPM Configuration

CPU C State Report	<b>[Enabled]</b> [Disabled]
Max CPU C-state	<b>[C7]</b> [C6] [C1]
SOix	<b>[Disabled]</b> [Enabled]

#### 4.4.7 Thermal Configuration Parameters

#### 4.4.8 IDE Configuration

Serial-ATA(SATA)	<b>[Enabled]</b> [Disabled]
SATA Test Mode	<b>[Disabled]</b> [Enabled]
SATA Speed Support	[Gen2] [Gen1]
SATA ODD Port	[No ODD] [Port0 ODD] [Port1 ODD] [Disabled]
<b>SATA Mode</b>	[AHCI Mode] [IDE Mode]
Serial-ATA Port 0	[Enabled] [Disabled]

SATA Port0 Hotplug	[Disabled]
	[Enabled]
Serial-ATA Port 1	[Enabled]
	[Disabled]
SATA Port1 Hotplug	[Disabled]
	[Enabled]
SATA Port0	
Not Present	
SATA Port1	
Not Present	

#### 4.4.9 Miscellaneous Configuration

#### 4.4.10 LPSS & SCC Configuration

LPSS & SCC Configuration	[ACPI Mode]
SCC Configuration	
SCC eMMC Support	[eMMC AUTO MODE]
SCC eMMC 4.5 DDR50 Support	[Enabled]
SCC eMMC 4.5 HS200 Support	[Disabled]
eMMC Secure Erase	[Disabled]
SCC SDIO Support	[Enabled]
SCC SD Card Support	[Enabled]
SDR25 Support for SDCard	[Disabled]
SDR50 Support for SDCard	[Enabled]
MIPI HSI Support	[Disabled]
LPSS Configuration	
LPSS DMA #1 Support	[Enabled]
LPSS DMA #2 Support	[Enabled]
LPSS I2C #1 Support	[Enabled]
LPSS I2C #2 Support	[Enabled]
LPSS I2C #3 Support	[Enabled]
LPSS I2C #4 Support	[Enabled]
LPSS I2C #5 Support	[Enabled]
LPSS I2C #6 Support	[Enabled]
LPSS I2C #7 Support	[Enabled]
NFC	[Disabled]
Touch Pad	[Disabled]

I2C touch Device Address	
LPSS HSUART #1 Support	[Disabled]
LPSS HSUART #2 Support	[Disabled]
LPSS PWM #1 Support	[Enabled]
LPSS PWM #2 Support	[Enabled]
LPSS SPI Support	[Enabled]

#### 4.4.11 System Component

#### 4.4.12 Network Stack Configuration

Network Stack	[Disabled]
---------------	------------

#### 4.4.13 CSM Configuration

CSM Support	[Enabled]
CSM16 Module Version	07.76
GateA20 Active	[Upon Request] [Always]
Option ROM Messages	[Force BIOS] [Keep Current]
Boot option filter	[UEFI and Legacy] [Legacy only] [UEFI only]
Network	[UEFI] [Do not launch] [Legacy]
Storage	[UEFI] [Do not launch] [Legacy]
Video	[Legacy] [UEFI] [Do not launch]
Other PCI devices	[UEFI] [Do not launch] [Legacy]

#### 4.4.14 SDIO Configuration

#### 4.4.15 USB Configuration

USB Configuration

USB Module Version 8.11.02

USB Devices:

1 keyboard, 2 Mice, 3 Hubs

Legacy USB Support:

[Enabled]

[Disabled]

XHCI Hand-off:

[Enabled]

[Disabled]

EHCI Hand-off:

[Disabled]

[Enabled]

USB Mass Storage Driver Support

[Enabled]

[Disabled]

USB hardware delays and time-outs:

USB transfer time-out:

[20 sec]

[10 sec]

[5 sec]

[1 sec]

Device reset time-out:

[20 sec]

[10 sec]

[30 sec]

[40 sec]

Device power-up delay

[Auto]

[Manual]

#### 4.4.16 Platform Trust Technology

Ftpm

[Disabled]

[Enabled]

#### 4.4.17 Security Configuration

## 4.5 Chipset Settings

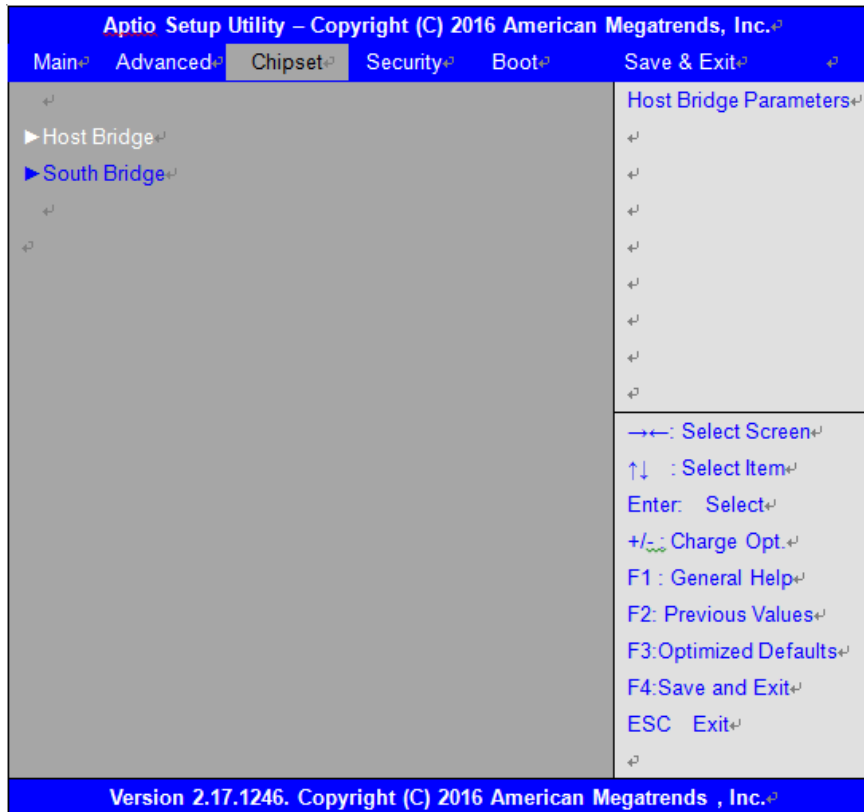

### 4.5.1 Host Bridge

#### ▶ Intel IGD Configuration

#### ▶ IGD – LCD Control

Force Lid Status	[On]
	[Off]
BIA	[Auto]
ALS Support	[Disabled]
IGD Flat Panel	[Auto]
Pannel Scaling	[Auto]

#### ▶ Memory Frequency and Timing

#### ▶ Graphics Power Management Control

Memory Information	
Total Memory	4096 MB(DDR3L)
Memory Slot0	4096 MB(DDR3L)
DIMM#1	Not Present
Max TOLUD	[Dynamic]
	[2GB]
	[2.25GB]
	[2.5GB]

	[2.75GB]
	[3GB]
Backlight PWM or DC Control	
	[PWM]
	[DC]
Backlight PWM Control	
	[PWM Normal by BIOS]
BIOS Control Backlight Level	
	[Level 7]
	[Level 0]
	[Level 1]
	[Level 2]
	[Level 3]
	[Level 4]
	[Level 5]
	[Level 6]
	[Level 8]
	[Level 9]
	[Level 10]
	[Level 11]
	[Level 12]
	[Level 13]
	[Level 14]
	[Level 15]
LCD Minimum brightness By Knob	
	[0%]
	[1%]
	[20%]

#### 4.5.2 South Bridge

- ▶ Azalia HD Audio
- ▶ USB Configuration
  - USB OTG Support [Disabled]
  - USB VBUS [On]
  - XHCI Mode [Smart Auto]
  - USB2 Link Power Management [Enabled]
  - USB 2.0(EHCI) Support [Enabled]
  - USB EHCI debug [Disabled]
  - USB Per Port Control [Enabled]

USB Port 0	[Enabled]
USB Port 1	[Enabled]
USB Port 2	[Enabled]
USB Port 3	[Enabled]

## 4.6 Security Settings



### 4.6.1 Administrator Password



### 4.6.2 User Password



Type the password with up to 20 characters and then press **<Enter>** key. This will clear all previously typed CMOS passwords. You will be requested to confirm the password. Type the password again and press **<Enter>** key. You may press **<Esc>** key to abandon password entry operation.

To clear the password, just press **<Enter>** key when password input window pops up. A confirmation

message will be shown on the screen as to whether the password will be disabled. You will have direct access to BIOS setup without typing any password after system reboot once the password is disabled. Once the password feature is used, you will be requested to type the password each time you enter BIOS setup. This will prevent unauthorized persons from changing your system configurations. Also, the feature is capable of requesting users to enter the password prior to system boot to control unauthorized access to your computer. Users may enable the feature in Security Option of Advanced BIOS Features. If Security Option is set to System, you will be requested to enter the password before system boot and when entering BIOS setup; if Security Option is set to Setup, you will be requested for password for entering BIOS setup.

## 4.7 Boot Settings

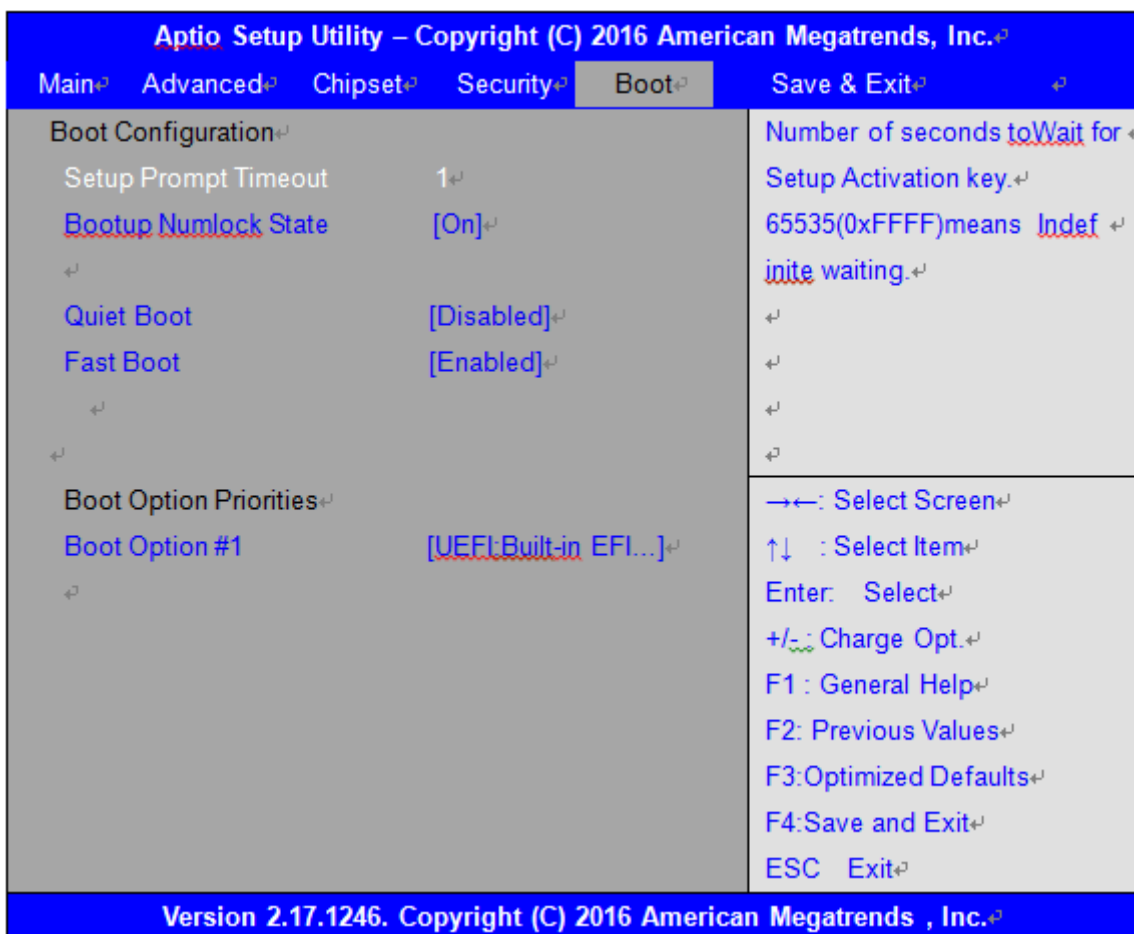

Setup Prompt Timeout	[1]
Bootup Numlock State	[On]
Quiet Boot	[off]
	[Disabled]
	[Enabled]



Fast Boot

[Disabled]

[Enabled]

Boot Option Priorities

Boot Option #1

Sets the system boot order

Hard Drive BBS Priorities

[SATA PM:\*\*\* ... ]

Boot Option #1

SATA PM:\*\*\*...

\*\*\*\*\*

Disabled

## 4.8 Save & Exit Settings

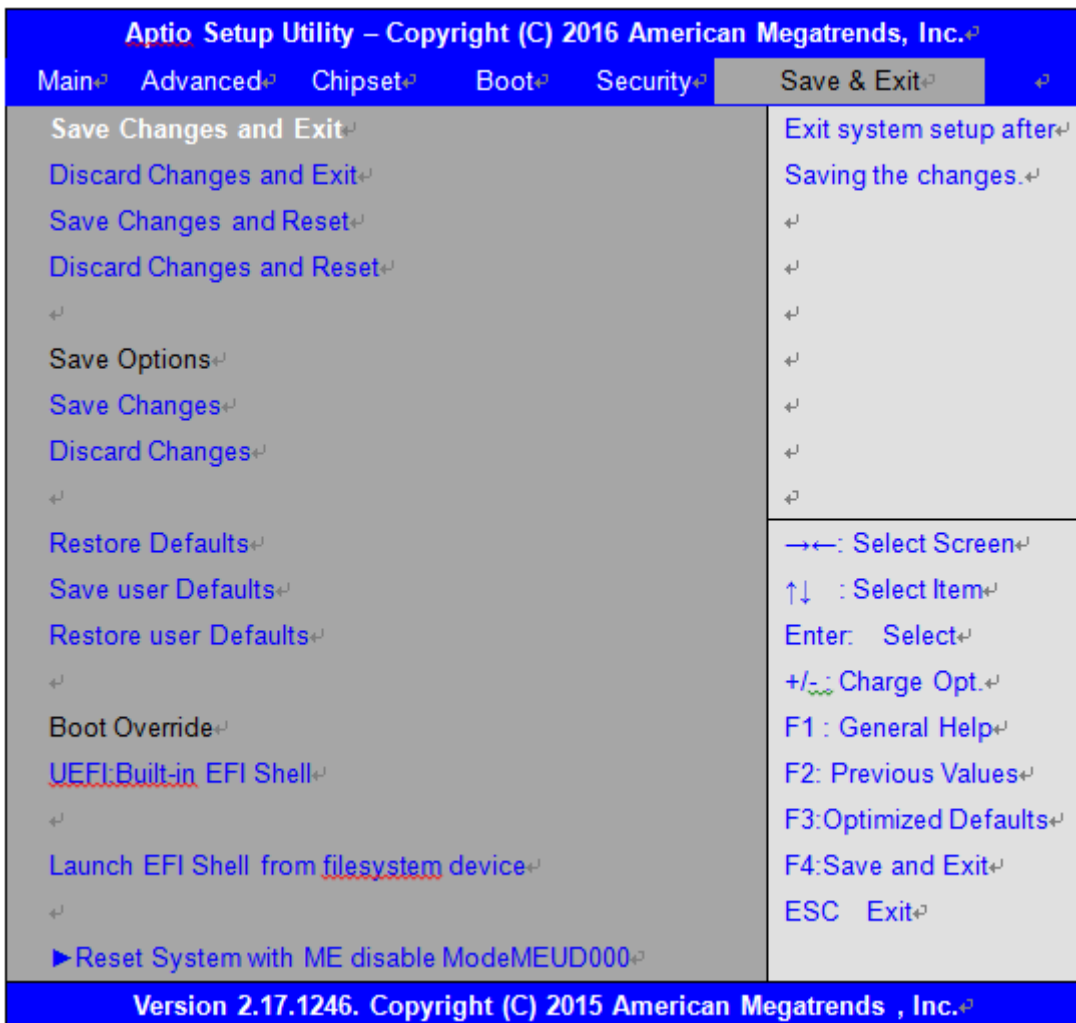

Save Changes and Exit

Save & Exit Setup save Configuration and exit ?

[Yes]

[No]

Discard Changes and Ext  
 Exit Without Saving Quit without saving?  
 [Yes]  
 [No]

Save Changes and Reset  
 Save & reset Save Configuration and reset?  
 [Yes]  
 [No]

Discard Changes and Reset  
 Reset Without Saving Reset without saving?  
 [Yes]  
 [No]

Save Changes  
 Save Setup Values Save configuration?  
 [Yes]  
 [No]

Discard Changes  
 Load Previous Values Load Previous Values?  
 [Yes]  
 [No]

Restore Defaults  
 Load Optimized Defaults Load optimized Defaults?  
 [Yes]  
 [No]

Save user Defaults  
 Save Values as User Defaults Save configuration?  
 [Yes]  
 [No]

Restore user Defaults  
 Restore User Defaults Restore User Defaults?  
 [Yes]  
 [No]

Launch EFI Shell from filesystem device  
 WARNING Not Found  
 [ok]

Reset System with ME disable ModeMEUD000  
 ME will runs into the temporary disable mode, Ignore if ME Ignition FWMEUD001.

This chapter describes the installation procedures for software and drivers under the windows 8.1 & 10. The software and drivers are included with the motherboard. The contents include **Intel/VGA chipset driver, Audio driver, Com Driver, and TXE(Win) Driver** Installation instructions are given below.

**Important Note:**

After installing your Windows operating system, you must install first the Intel Chipset Software Installation Utility before proceeding with the installation of drivers.

**FABS Series**

**WIN8.1& WIN10 - DRIVER**

**DRIVERS**

- Intel(R) AtomTM SoC Chipset
- Intel(R) VGA Chipset
- Realtek ALC662 HD Audio Driver
- Touch Panel Driver
- Com Driver
- Intel\_TXE(Win) Driver

**OTHERS**

- User Manual

View EXIT

## 5.1 Intel(R) Atom™ SoC Chipset

To install the Intel chipset driver, please follow the steps below.

**Step 1.** Select **Intel (R) Atom™ SoC Chipset** from the list



**Step 2.** Here is welcome page. Please make sure you save and exit all programs before install. Click **Next**.

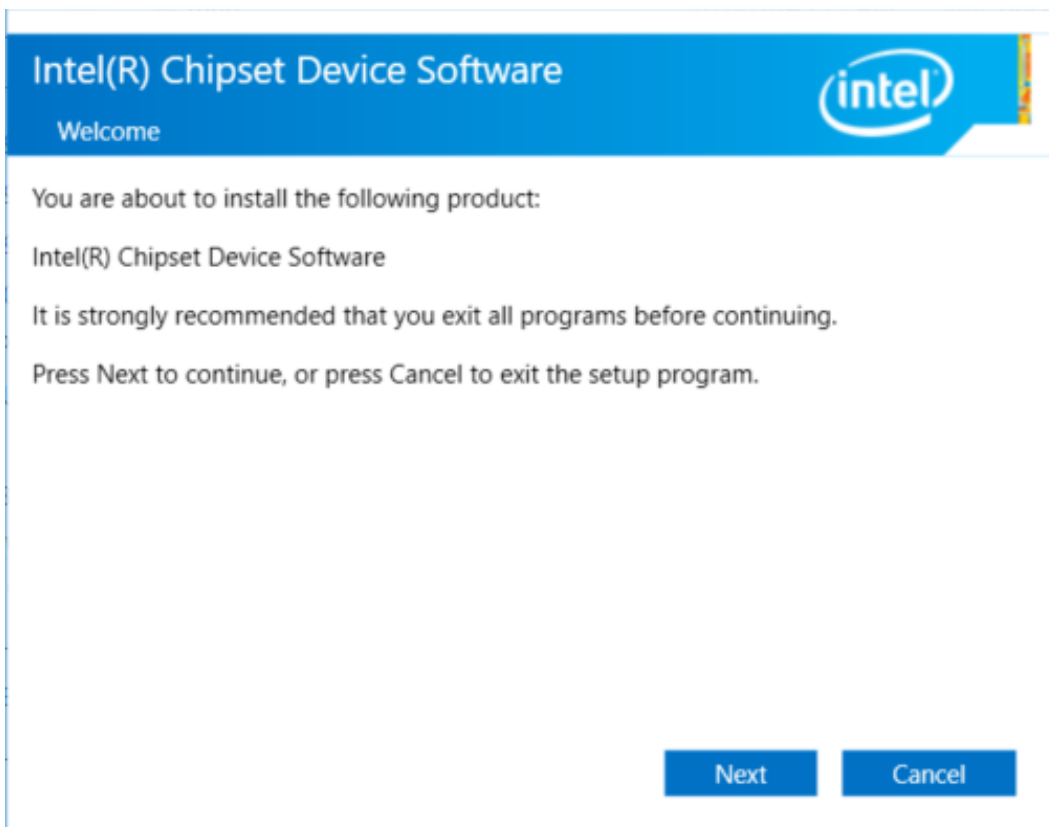

**Step 3.** Read the license agreement. Click **Accept** to accept all of the terms of the license agreement.

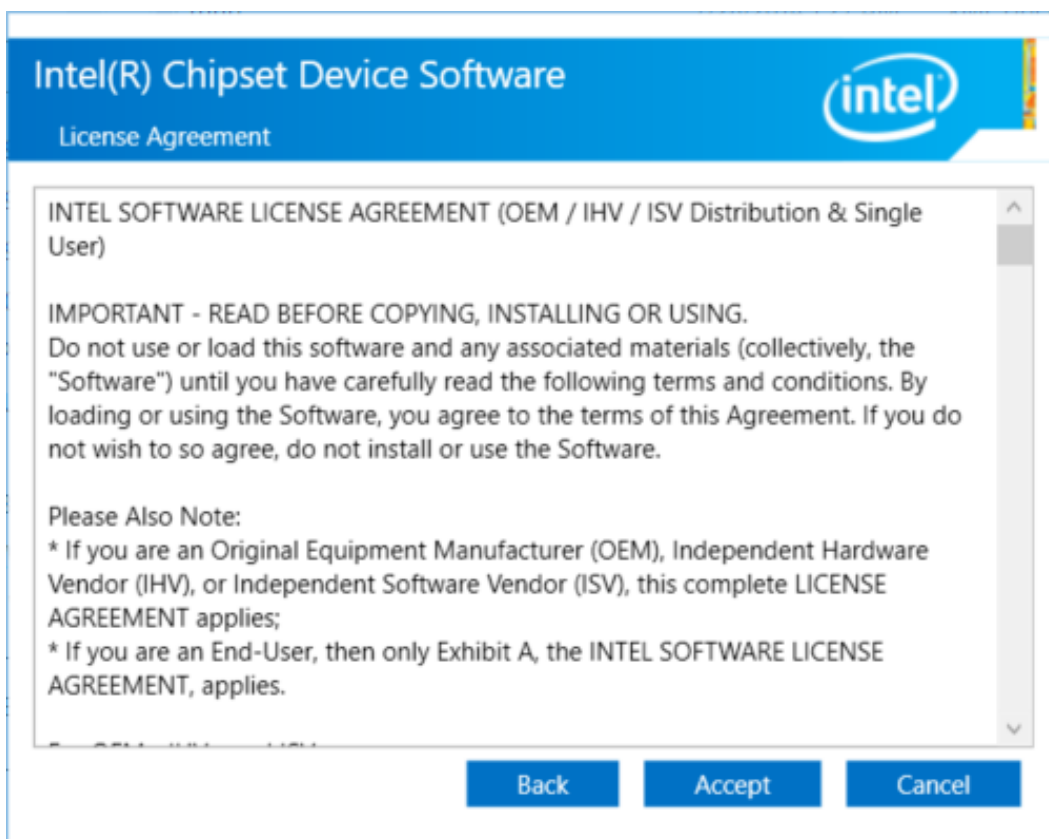

**Step 4.** Click **Install** to begin the installation.

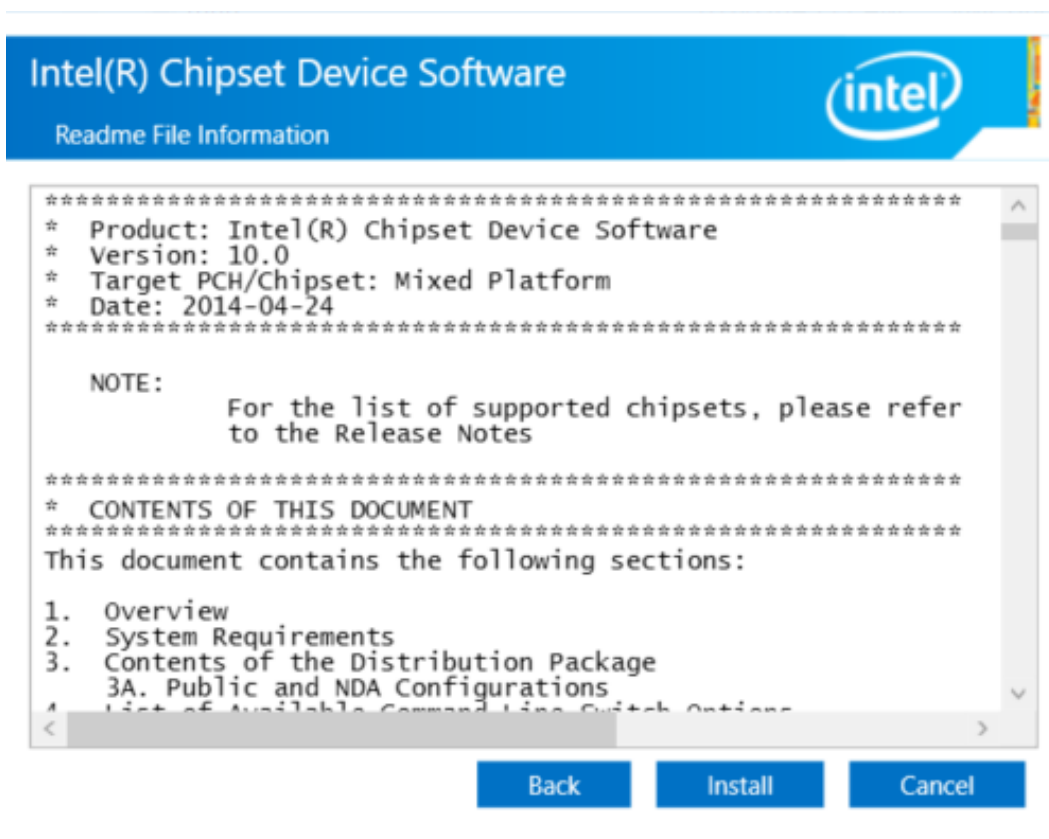

**Step 5.** Click **Finish** to exit the wizard.

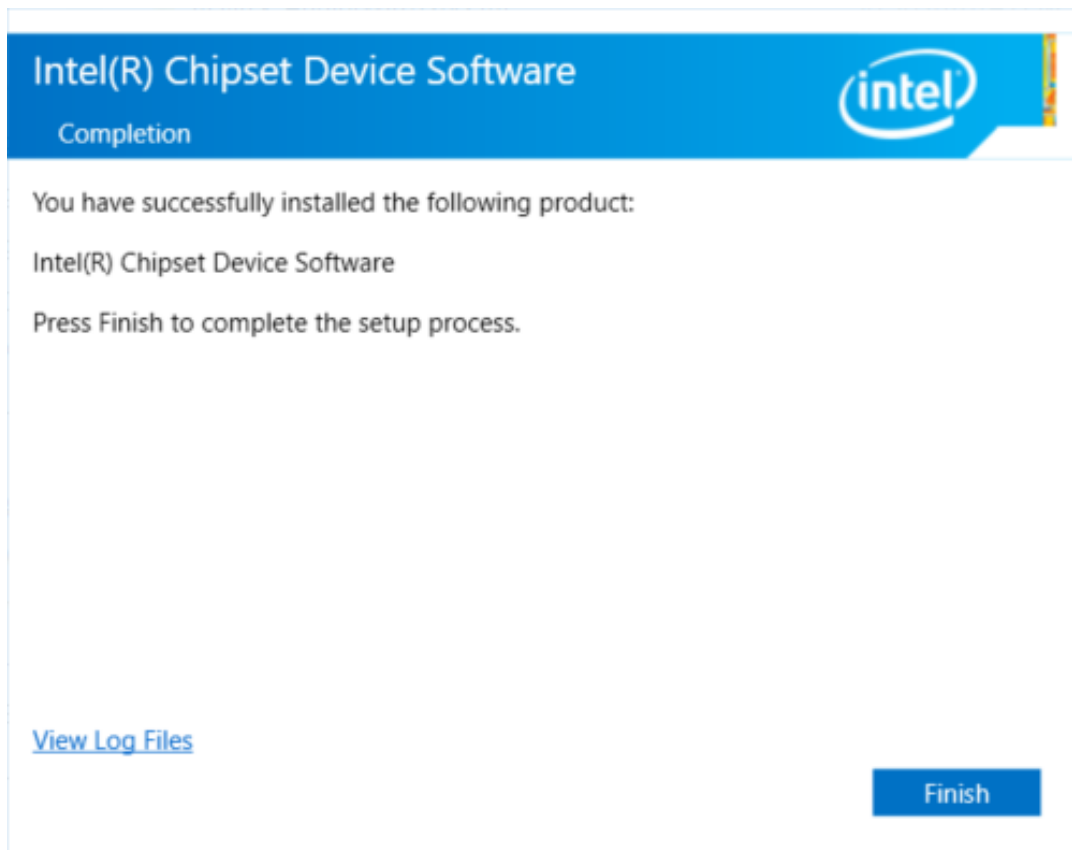

## 5.2 Intel(R) VGA Chipset

To install the Intel (R) VGA Chipset, please follow the steps below.

**Step 1.** Select **Intel(R) VGA Chipset** from the list.



**Step 2.** . Click **Next**.

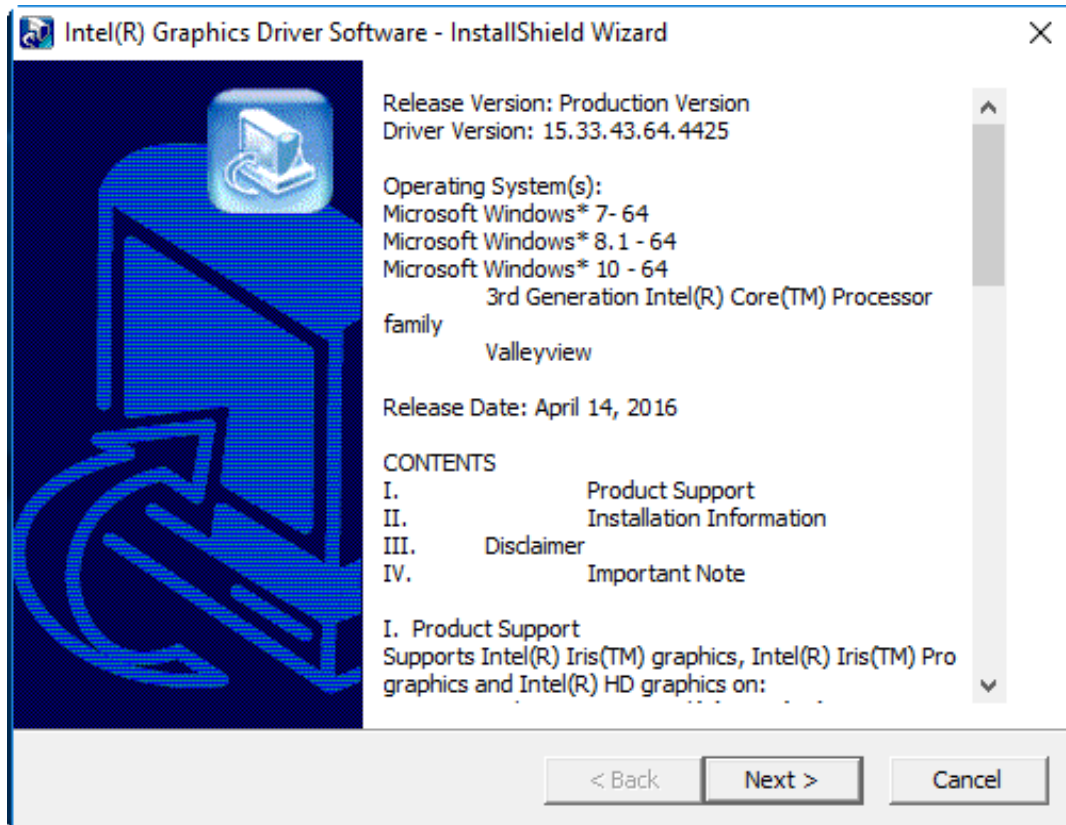

**Step 3.** Choose **automatically run** function and Click **Next** to setup program.

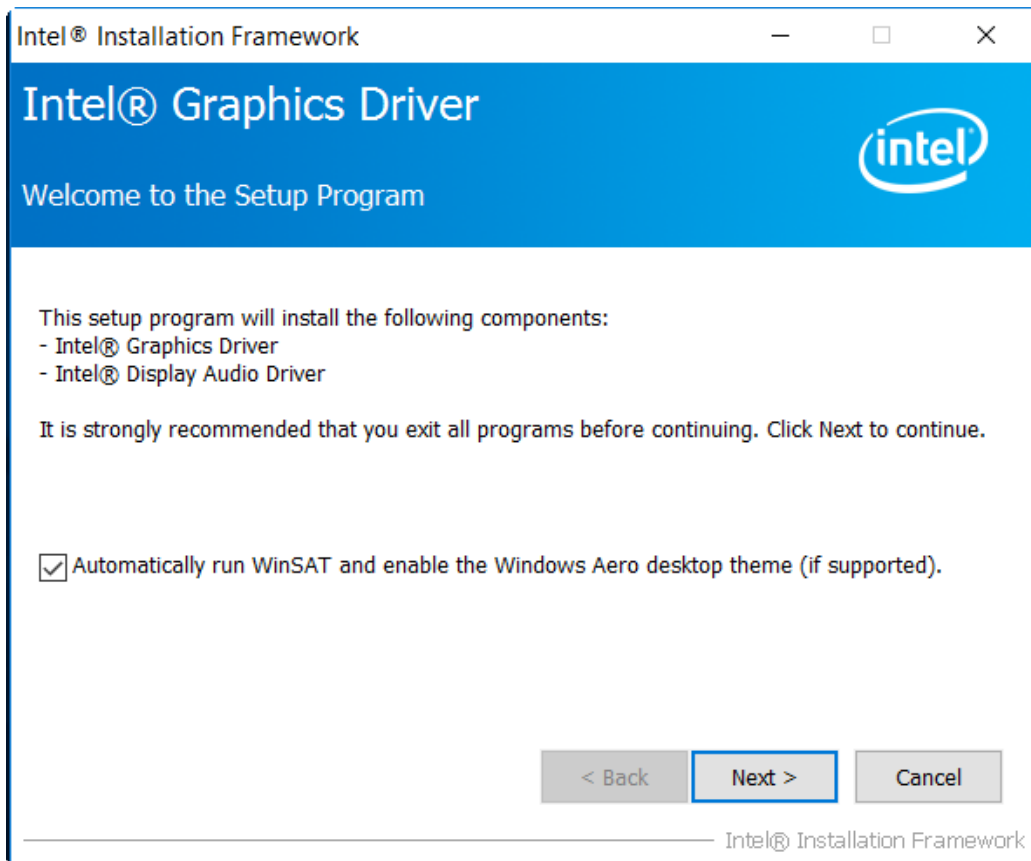

**Step 4.** Read the license agreement. Click **Yes** to accept all of the terms of the license agreement.

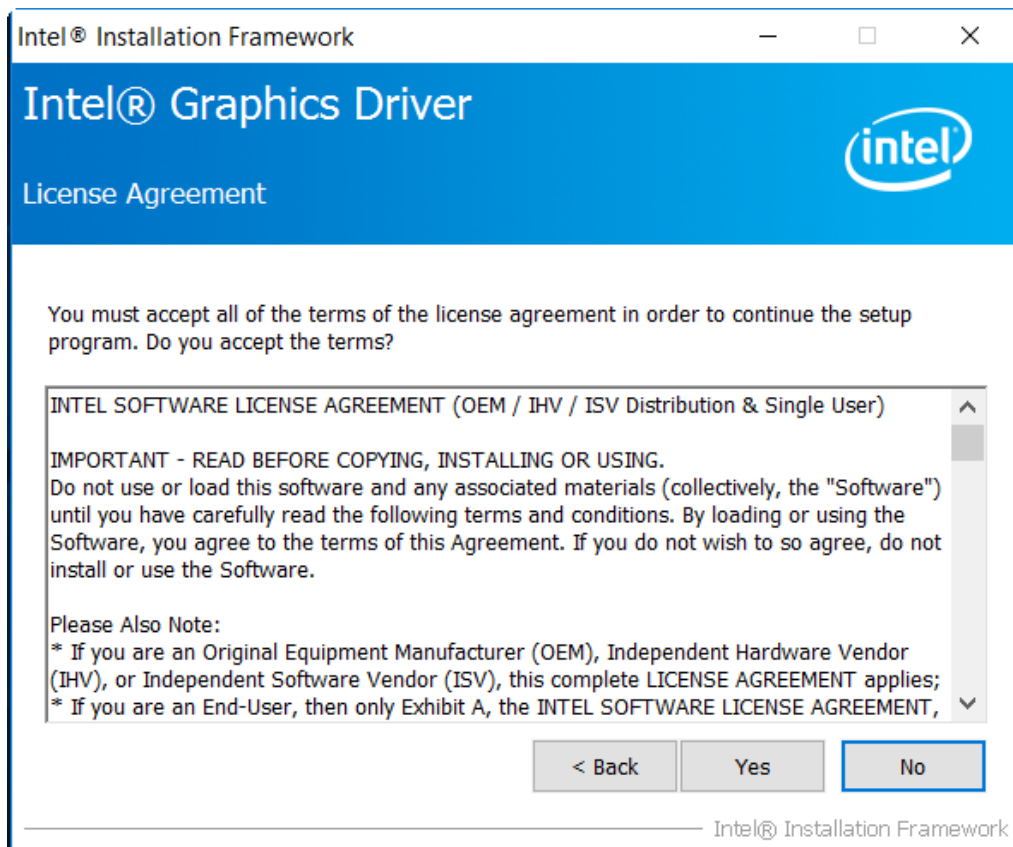



**Step 5.** Click **Next** to continue.

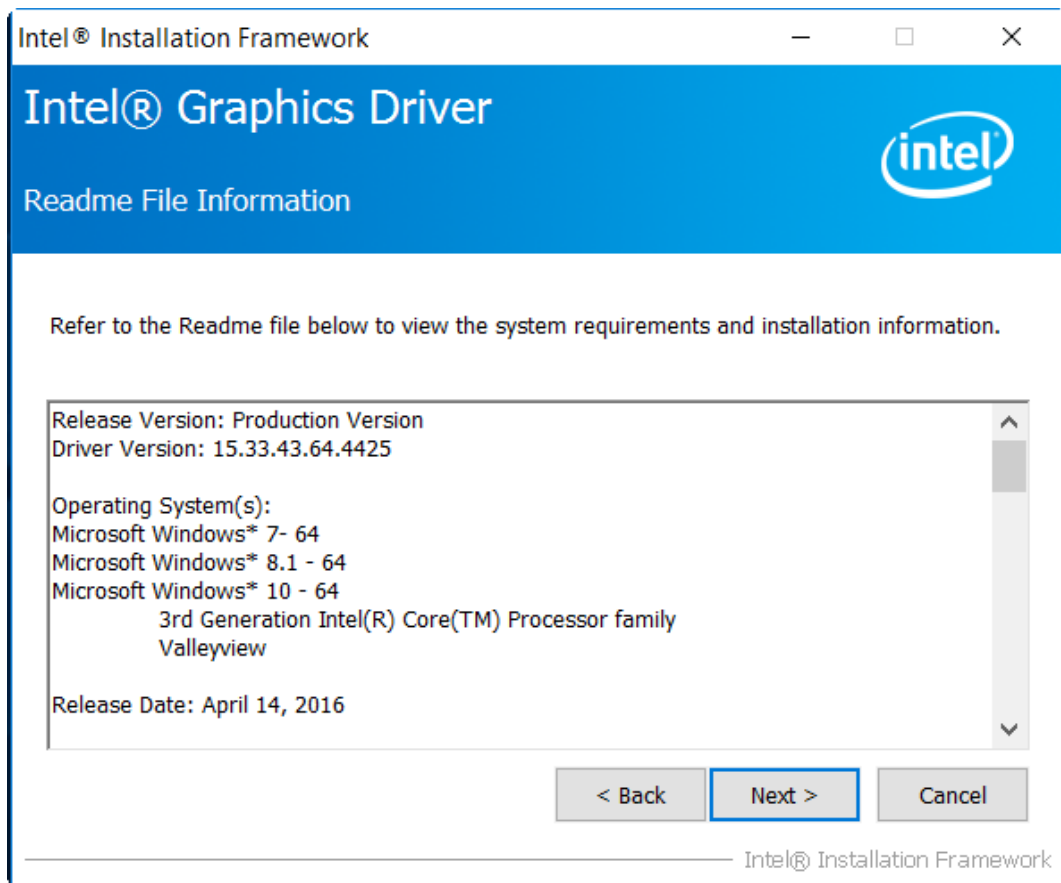

**Step 6.** Click **Next** to continue.

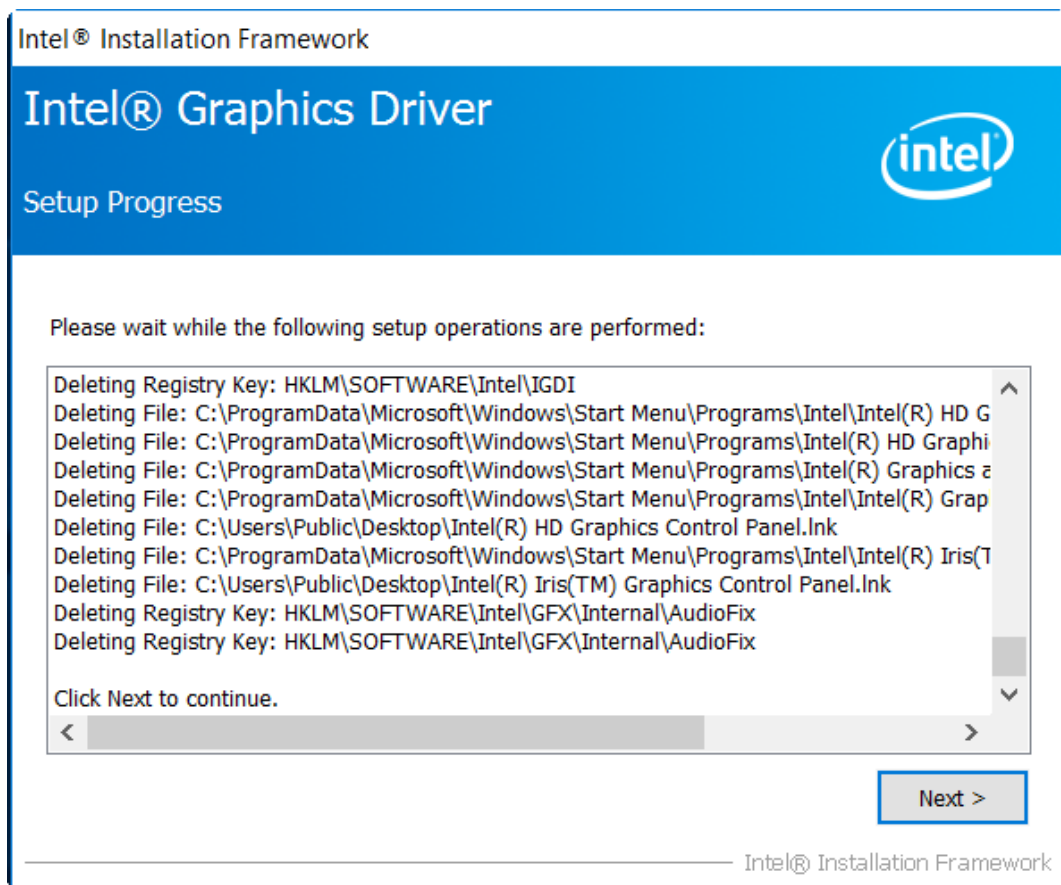

**Step 7.** Select **Yes, I want to restart this computer now.** Click **Finish**, then remove any installation media from the drives.

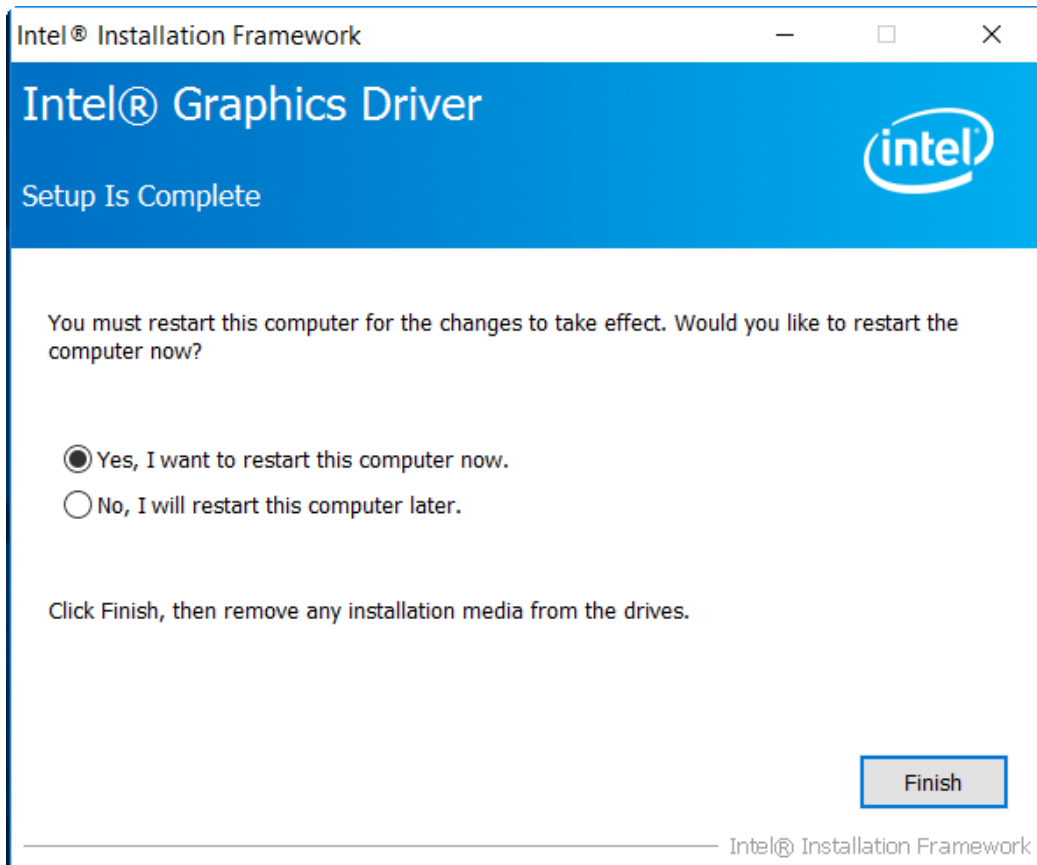

## 5.3 Realtek ALC662 HD Audio Driver Installation

To install the Realtek ALC662 HD Audio Driver, please follow the steps below.

**Step 1.** Select **Realtek AL662 HD Audio Driver** from the list



**Step 2.** Click **Next** to continue.

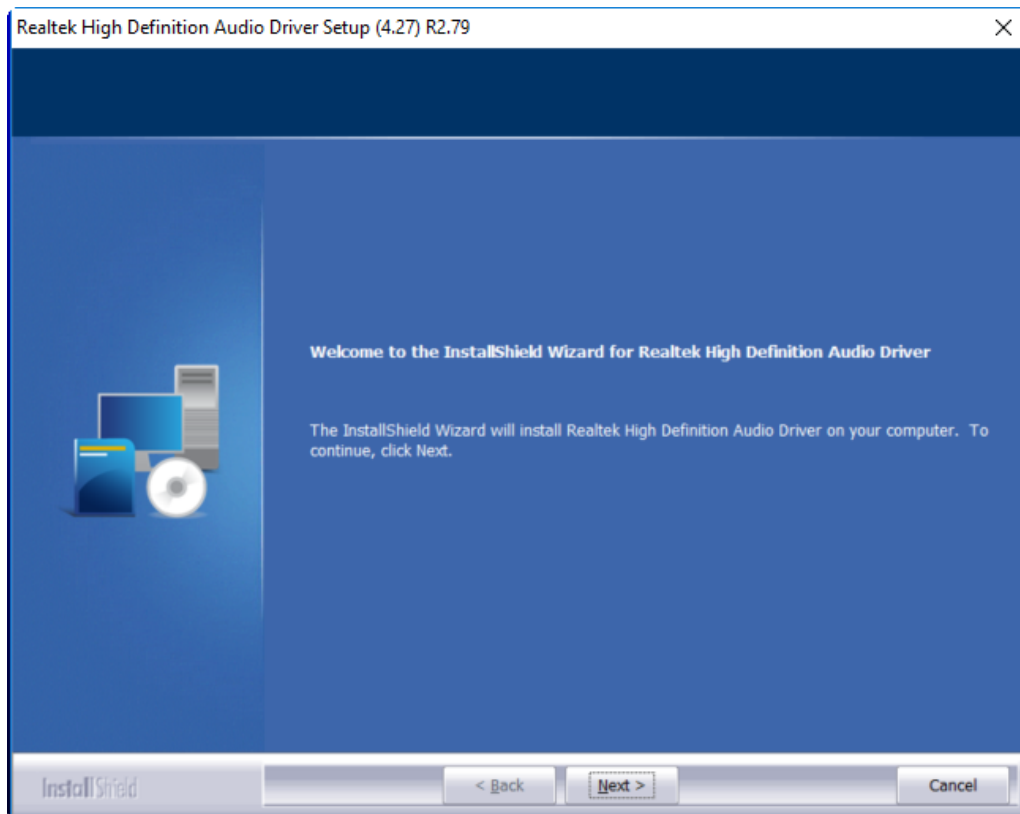

**Step 3.** Click **Yes, I want to restart my computer now.** Click **Finish** to complete the installation.

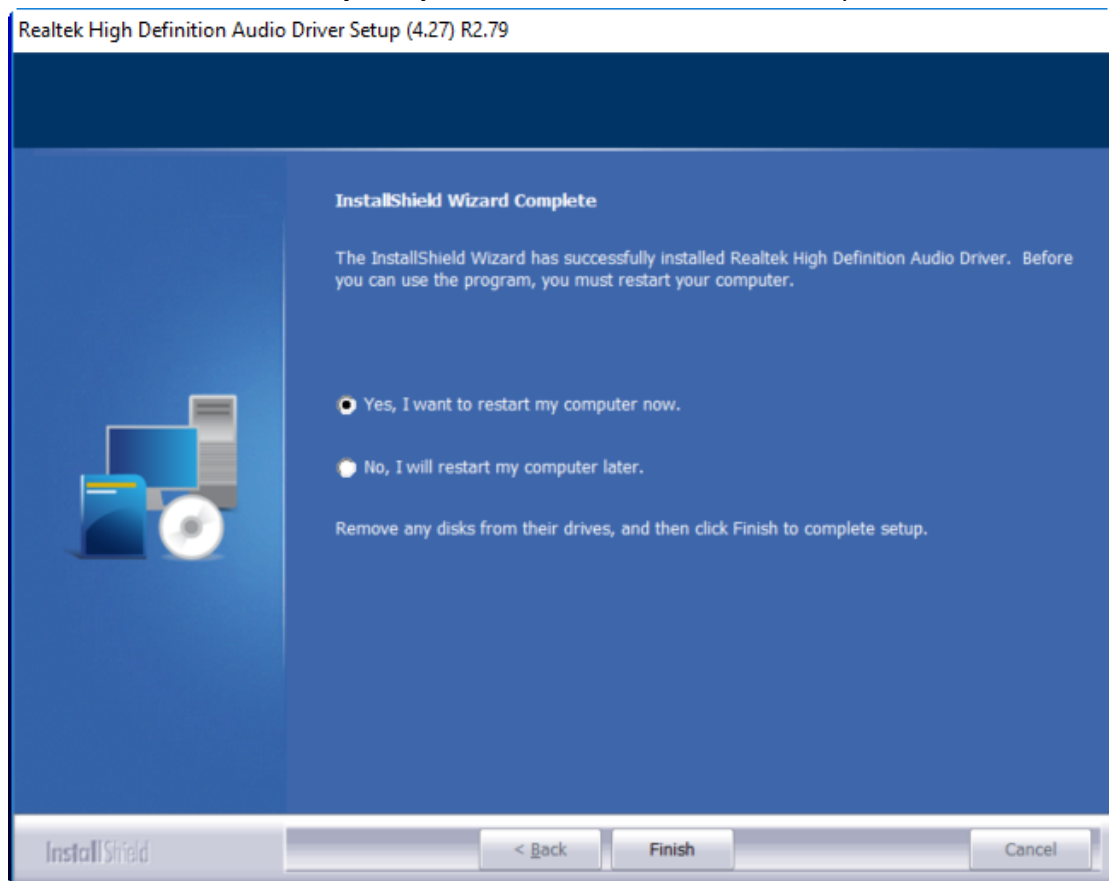

## 5.4 Com Driver

To install the Com Driver, please follow the steps below.

**Step 1.** Select **Com Driver** from the list



**Step 2.** Select setup language you need. Click **Next** to continue.

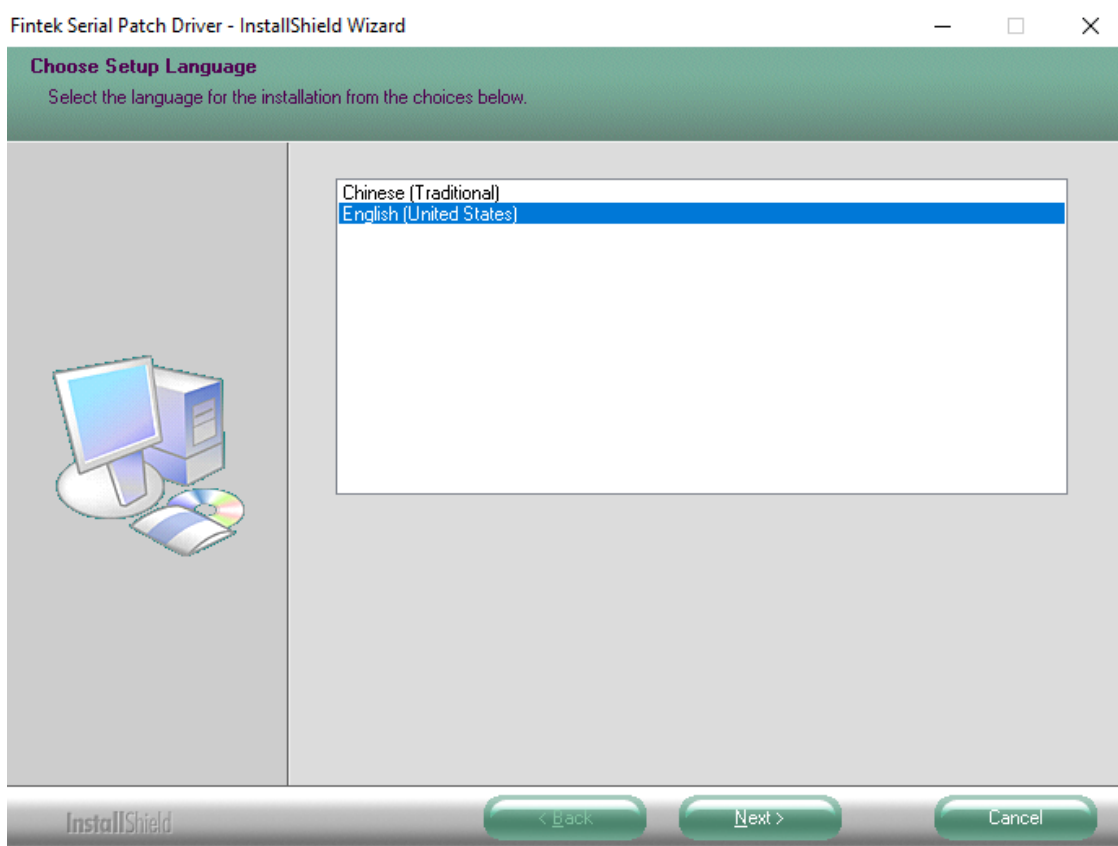

**Step 3.** Click **Next** to begin the installation.

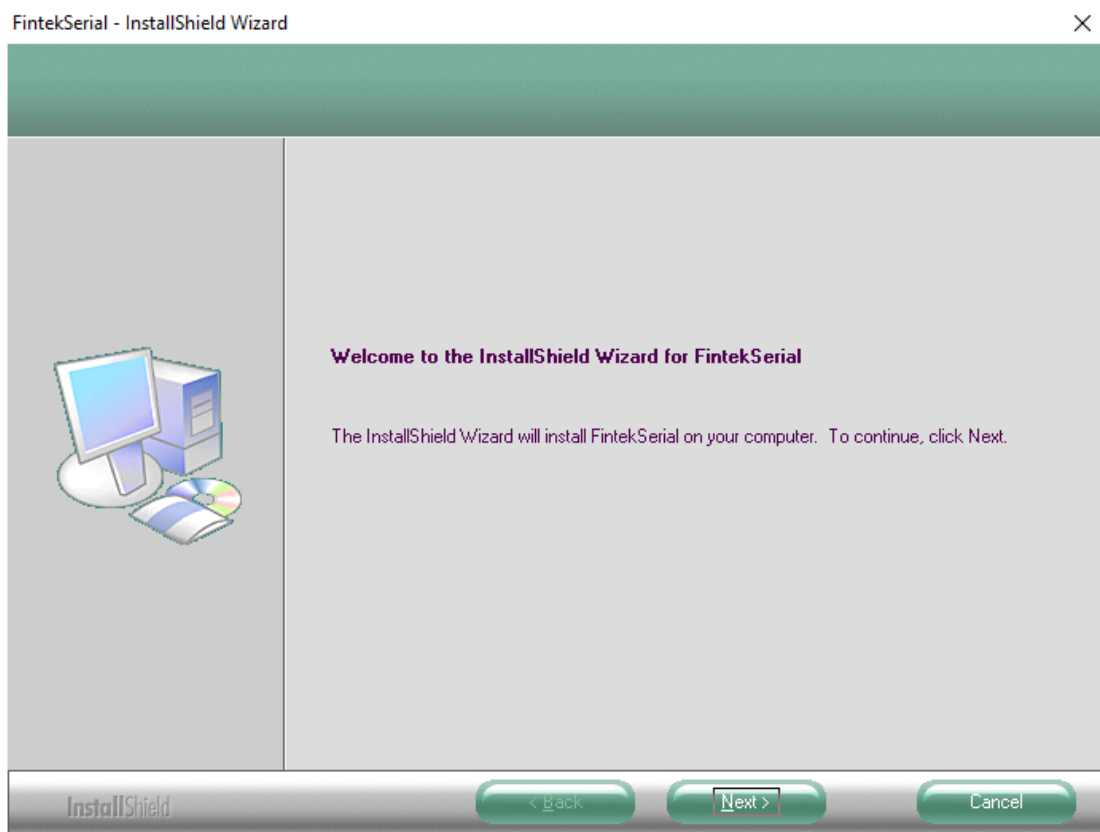

**Step 4.** Choose **Yes, I want to restart my computer now**. Click **Finish** to complete the installation.

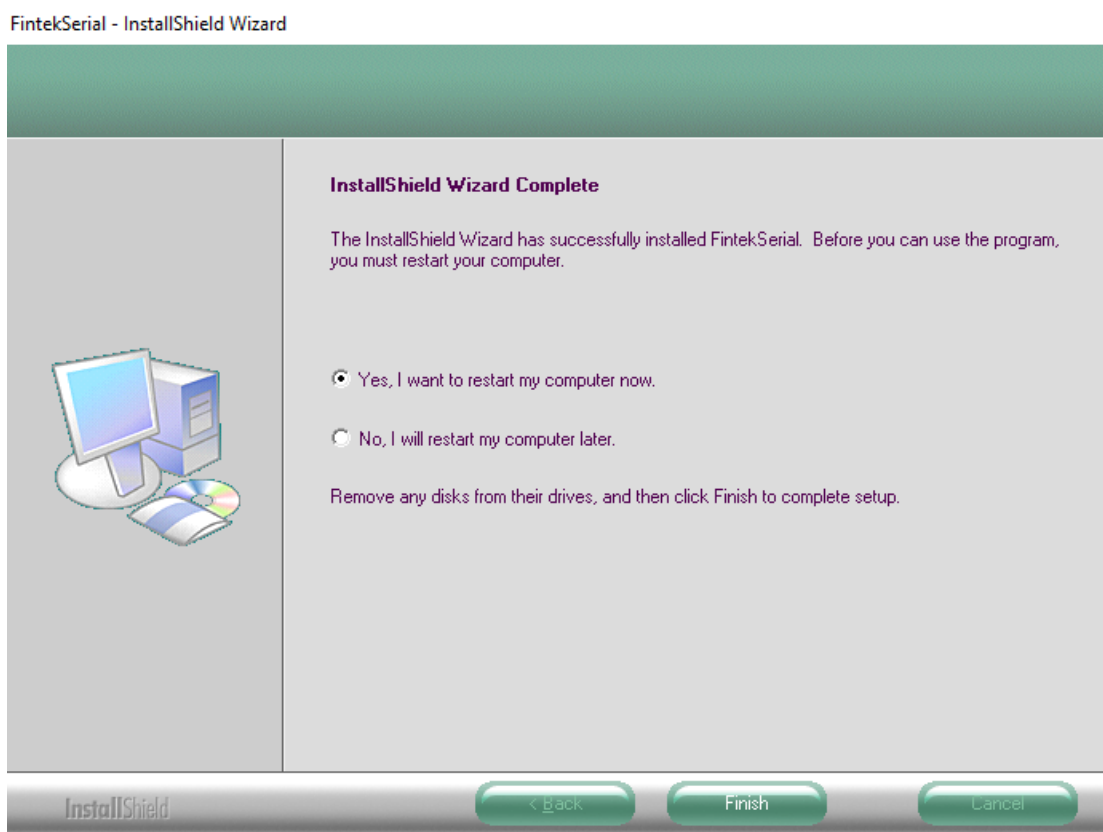

## 5.5 Intel\_TXE(Win) Driver

To install the Intel\_TXE(Win) Driver, please follow the steps below.

**Step 1.** Select **Intel\_TXE(Win) Driver** from the list



**Step 2.** Click **Next** to continue.

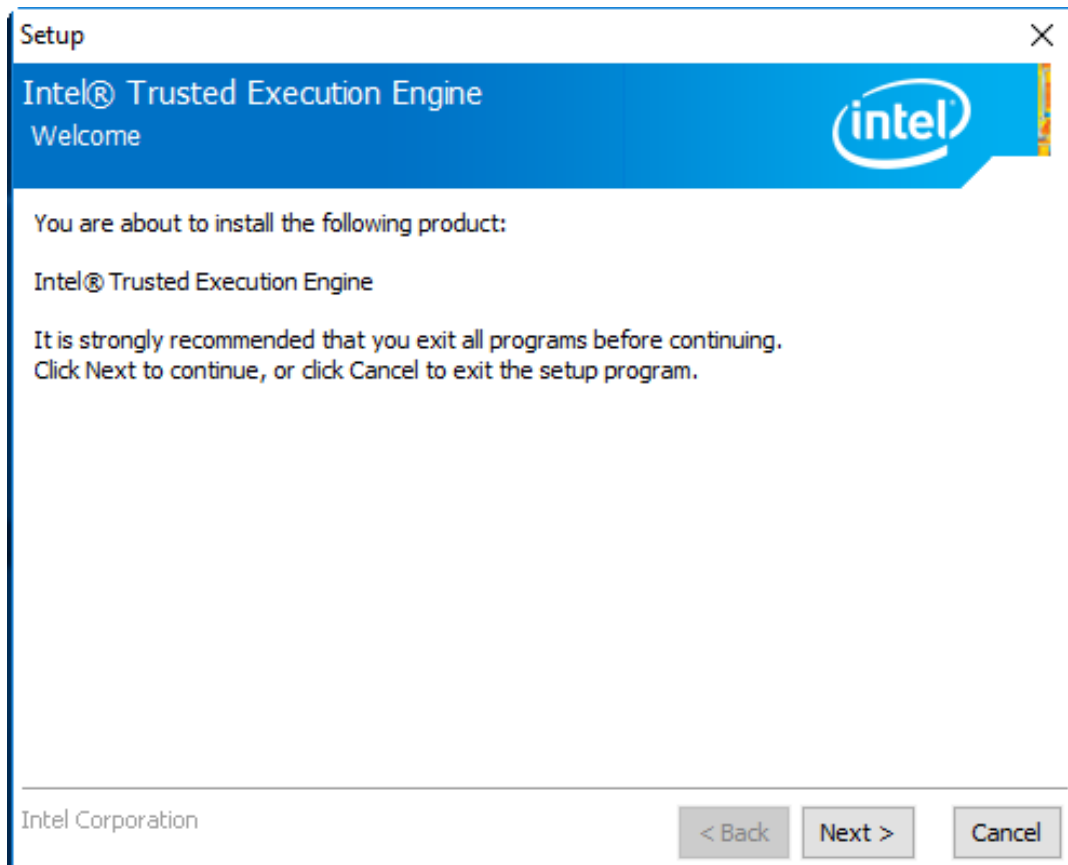

**Step 3.** Read the license agreement. Choose **Accept** and click **Next** to accept all of the terms of the license agreement.

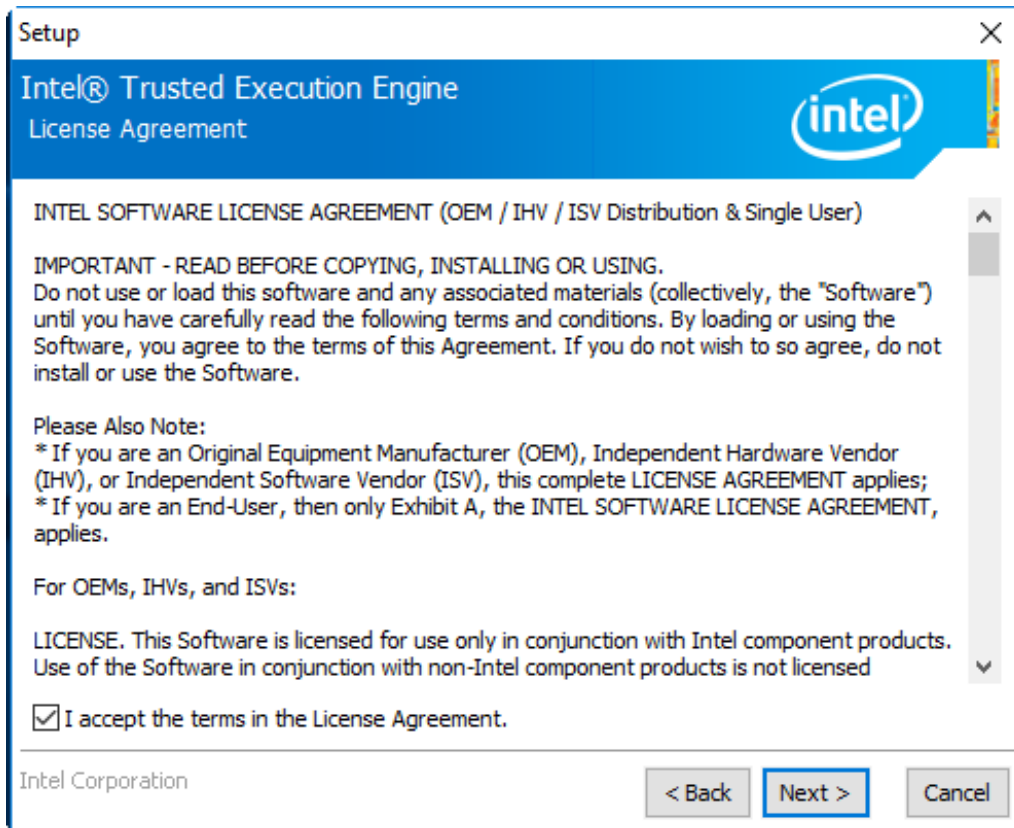

**Step 4.** Click **Next** to continue.

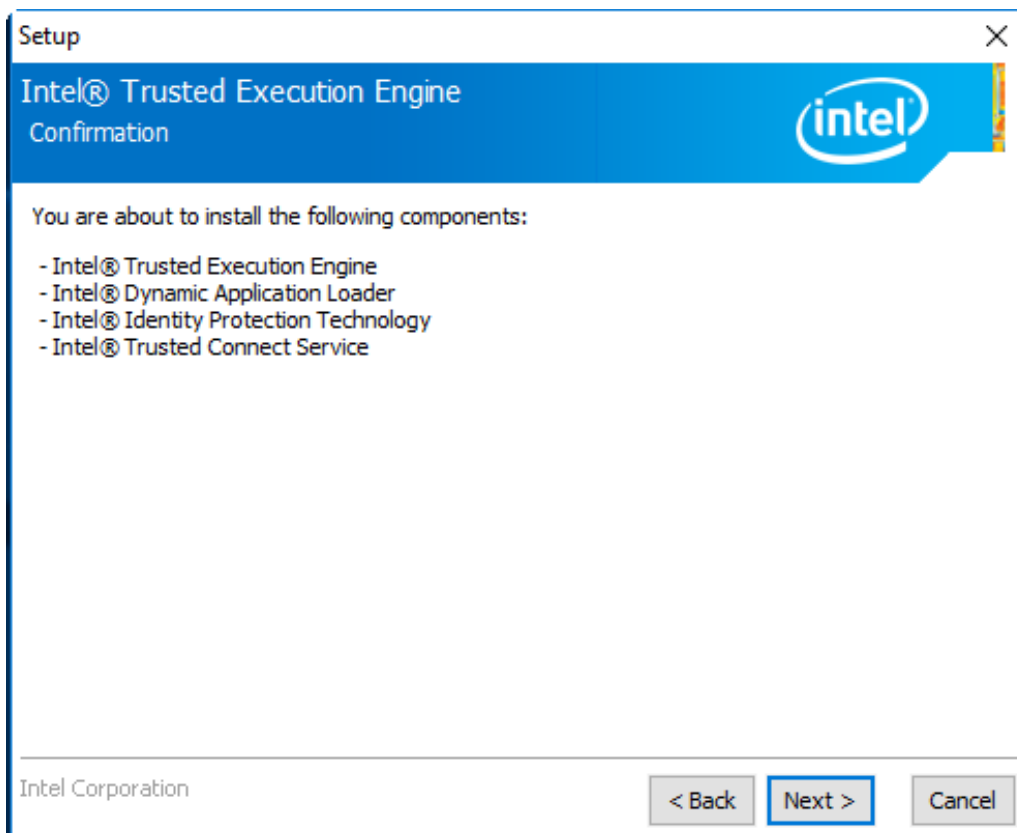



**Step 5.** Click **Finish** to complete the installation.

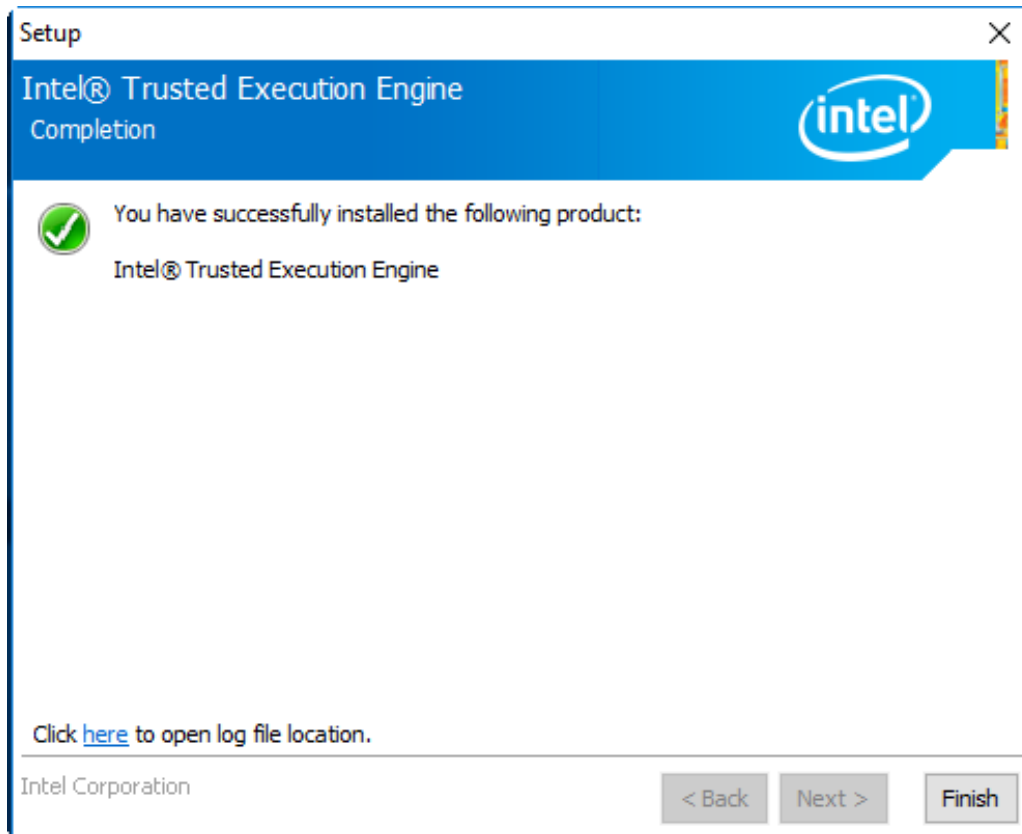

Unplug the product before you cleaning. If your mechanical cleaning is necessary, please refer the information below to avoid product damaging during cleaning.

- Keep the surface clean. Remove cleaners and food residue immediately. Always avoid the return of food stuff splashes to the production process.
- Keep surface of product being properly ventilated.
- If mechanical cleaning is necessary, do not use cleaning equipment made of metal.
  - Use brushes made of plastic or natural materials, or a microfiber pad.
  - Use plenty of water or we suggest using 75% alcohol of medical to clean or disinfect the surface.
  - Make sure that the cleansing agent is completely removed without any residue.
- Make sure surface is not damaged: Do not damage the device during operation, or by cleaning or repairing it using hard tools, in particular tools made of corrodible materials.
- Immediately remove any stains or rust and new rust spots with a mild detergent in order to prevent from any further corrosion.
- Rinse the part thoroughly and keep product dry after you cleaned it.